

# Operating Instructions Testomat® EVO TH

Online analysis instrument  
for residual total hardness  
(water hardness)



# Content

|  |           |
|--|-----------|
| <b>Content</b> .....   | <b>2</b>  |
| <b>Important safety information</b> .....  | <b>5</b>  |
| Intended use .....   | 5         |
| Qualification of personnel .....   | 5         |
| Warnings in this manual .....  | 6         |
| Additional documentation .....   | 6         |
| Special attention is required at this point .....  | 6         |
| General Information .....  | 6         |
| Requirements for the installation site.....  | 6         |
| Requirements of cable for mains voltage and system components<br>and installed lines ..... | 7         |
| Requirements for cable ducts .....   | 7         |
| During assembly .....  | 8         |
| During operation .....   | 8         |
| During cleaning .....  | 9         |
| Malfunctions/repairing a defective device.....   | 9         |
| During disposal .....  | 9         |
| Operating requirements .....   | 10        |
| <b>Delivery includes:</b> .....  | <b>11</b> |
| <b>Service description</b> .....   | <b>11</b> |
| Available indicators for Testomat® EVO TH devices .....                                    | 12        |
| <b>Assembly</b> .....  | <b>13</b> |
| Assembling the Testomat® EVO TH .....  | 13        |
| Use of the Testomat® EVO TH within a pressure range of 0.3 to 1 bar13                      |           |
| Connecting the water intake and discharge.....   | 14        |
| Water intake.....  | 14        |
| Water drain .....  | 15        |
| Connect mains and devices.....   | 15        |
| Block diagram of Testomat® EVO TH.....   | 16        |
| Internal structure of Testomat® EVO TH.....  | 17        |
| Cable glands .....   | 18        |
| Connect mains voltage .....  | 18        |
| Connect system components .....  | 19        |
| Connect inputs and outputs .....   | 21        |
| RS232 interface terminal assignment.....   | 22        |
| <b>Connect indicator bottle</b> .....  | <b>23</b> |
| Insert indicator bottle .....  | 23        |
| Open water intake.....   | 23        |
| Device settings and data input.....  | 24        |
| <b>Functions of the control and display elements</b> .....                                 | <b>24</b> |
| Switching the Testomat® EVO TH device on/off.....  | 24        |
| Display functions.....   | 25        |
| Control and function keys .....  | 26        |
| Operating system.....  | 27        |
| Control elements on the control board.....   | 30        |
| Mounting the SD card .....   | 30        |
| Status displays of the SD card.....  | 30        |
| <b>Getting started</b> .....   | <b>31</b> |
| <b>Input basic programming data</b> .....  | <b>32</b> |
| Select operating mode .....  | 32        |
| Select timing control.....   | 32        |

|  |           |
|--|-----------|
| Select quantity control .....                                    | 32        |
| Select quantity control/time priority .....                      | 33        |
| Configure interval (interval pause) .....                        | 33        |
| Select indicator type and container size .....                   | 34        |
| Select measurement value unit.....                               | 34        |
| Limit value monitoring .....                                     | 35        |
| Input operating mode of LV1 and LV2 limit value outputs .....    | 35        |
| Switching functions of the LV1 and LV2 limit value outputs ..... | 36        |
| Input purge cycle.....   | 37        |
| Select water meter .....   | 38        |
| BOB operation (operation without constant supervision) .....     | 38        |
| Description of the relay outputs .....                           | 39        |
| LV1 and LV2 limit value outputs .....                            | 39        |
| AUX (programmable functional output) .....                       | 40        |
| Alarm (Fault signal output).....                                 | 40        |
| Alarm/message – How to proceed when errors occur.....            | 41        |
| Water shortage .....   | 42        |
| Error history.....   | 42        |
| Description of the signal inputs/outputs .....                   | 43        |
| Stop input.....  | 43        |
| External delete (external acknowledge) .....                     | 44        |
| Input water meter .....  | 44        |
| Current loop 0/4 - 20 mA.....                                    | 44        |
| Calculation of output currents .....                             | 45        |
| Serial interface .....   | 46        |
| Notification format.....   | 46        |
| LCD settings.....  | 47        |
| Description of the SD card functions .....                       | 47        |
| Storing measurement values .....                                 | 48        |
| Store error .....  | 48        |
| Interim storage for a non-inserted SD card .....                 | 49        |
| Capacity of the SD card.....                                     | 49        |
| Export basic programming data.....                               | 49        |
| Import basic programming data.....                               | 50        |
| Password protection .....  | 50        |
| Password input .....   | 50        |
| Change password.....   | 51        |
| Password protection .....  | 51        |
| Firmware update .....  | 51        |
| Menu-driven firmware update .....                                | 51        |
| Manual firmware update .....                                     | 53        |
| Maintenance.....   | 53        |
| Configuring the maintenance interval .....                       | 53        |
| Acknowledge the maintenance.....                                 | 53        |
| <b>Information menu "i" .....</b>                                | <b>54</b> |
| <b>Service menu.....</b>   | <b>55</b> |
| <b>Structure of basic programming .....</b>                      | <b>57</b> |
| <b>Error messages/troubleshooting .....</b>                      | <b>58</b> |
| Further possible errors .....                                    | 61        |
| Error messages after self-test.....                              | 61        |
| Firmware update error list.....                                  | 63        |
| <b>Servicing and maintenance .....</b>                           | <b>66</b> |

|   |           |
|---|-----------|
| Description of the maintenance work.....                      | 66        |
| Replacing indicator .....                                     | 66        |
| Setting indicator fill level .....                            | 67        |
| Cleaning measuring chamber and sight glasses.....             | 67        |
| Cleaning the filter housing .....                             | 67        |
| Care instructions .....                                       | 68        |
| Replacing the backup battery .....                            | 68        |
| Replacing fuses .....   | 69        |
| Checklist Testomat® EVO TH .....                              | 74        |
| <b>Spare parts and accessories for Testomat® EVO TH .....</b> | <b>76</b> |
| Accessory.....  | 77        |
| <b>Technical Data.....</b>                                    | <b>78</b> |
| Declaration of conformity .....                               | 79        |
| NRTL certificate .....  | 80        |
| Test-type approval certificate.....                           | 81        |

## Important safety information



Read the operating instructions carefully and in full before working with the device.

Ensure that the operating instructions are accessible at any time for all users. When an SD is used in the device, it can also be stored on the same as a PDF file.

If transferring the Testomat® EVO TH device to third parties, ensure these operating instructions are always included.

Observe the safety precautions and safety recommendations when using reagents, chemicals and cleaning agents. Observe the relevant safety data sheet! For reagents we supply, the relevant safety data sheets are available online at <http://www.heylanalysis.de>.

### Intended use

The scope of use of the Testomat® EVO TH is the automatic determination and monitoring of the residual total hardness (water hardness) in water. In the process, the required measurement scope is determined based on the selected indicator and corresponding user programming.

Comply with the output limits specified in the "[Technical Data](#)" section.

Observe the areas/limits of application of the indicators and the requirements imposed by the medium to be measured.

The scope of intended use presumes that you have read and understood the instructions and particularly the section on "[Important safety information](#)".

Improper use is deemed to occur if you use the device

- outside the applicable scope, as specified in these instructions,
- under operating conditions that deviate from the scope specified in these instructions.

### Qualification of personnel



The assembly and commissioning require basic electrical and process engineering expertise as well as knowledge of the applicable specialist terms. The assembly and commissioning must therefore be performed only by a specialist or a properly trained person instructed and supervised by a specialist.

A specialist is a person who can draw on professional training, knowledge and experience as well as knowledge of applicable provisions to assess work assigned to him/her, detect potential hazards and implement suitable safety measures. A specialist must comply with the applicable professional rules.

## Warnings in this manual

These instructions include warnings against specified actions that involve the risk of injury or property damage. Warnings are structured as follows:



---

### Description of the type or source of danger

Description of the consequences of non-compliance

Hazard prevention indications. Compliance with these hazard prevention measures is imperative.

---



The signal word "**RISK**" refers to a significant danger that represents a direct threat and will definitely result in severe injuries or even be fatal if not avoided.



The signal word "**WARNING**" refers to a possible danger that may result in severe injuries or even be fatal if not avoided.



The signal word "**CAUTION**" refers to a potentially dangerous situation that could result in minor to moderate injuries or property damage if not avoided.



The signal word "**NOTE**" refers to important pieces of information. If this information is not heeded, it may adversely affect operational procedures.

## Additional documentation

The Testomat® EVO TH device is a system component. Accordingly, you should also observe the Testomat® EVO TH service manual and the system documentation of the system manufacturer.

## Special attention is required at this point

### General Information



- During assembly and commissioning, observe the specific national and local requirements.
- Observe the accident prevention and conservation requirements in the country of use and at the installation site.
- Make no changes or modifications to the device that go beyond the scope of use specified in these instructions. Doing so will void the warranty.

### Requirements for the installation site

Ensure that the following conditions are met at the installation site:

- Use the device in indoor locations only.
- The ambient temperature is between 10 and 40°C.
- The installation site is at altitudes under 2000 m.
- The maximum relative humidity is 80% at temperatures of up to 31°C (linear declining up to 50% relative humidity at 40°C).

- The device must always be protected against wetness and moisture. Under no circumstances may it be exposed to splashed water or condensate.
- Surge category II
- Soiling degree II

### Requirements of cable for mains voltage and system components and installed lines

Use only cables and installed lines which meet the following requirements:

- Dielectric strength 30 V ... 260 V according to the nominal voltage (see specification plate)
- The cable ducts installed by Gebr. Heyl in the device have a clamping range of 4.5 mm – 10 mm. This means that the external diameter of the laid cable must remain within the range of 4.5 mm – 10 mm. If you use other ducts, the cable diameters must correspond to the ducts.
- The terminal strips on the circuit board require core cross-sections of between 0.08 mm<sup>2</sup> and 2.5 mm<sup>2</sup>. This applies to single-wire and fine-wire cores with wire end ferrules without plastic collar. For fine-wire cores with wire end ferrules and plastic collar, the cross-section may be up to 1.5 mm<sup>2</sup>. For single-wire cores, AWG28 – AWG12 can also be used.

#### NOTE

#### Optimum cross-section of the cores

If the core cross-section is less than 0.5 mm<sup>2</sup>, jamming may occur when the cores are loosened from the terminal strip. We therefore recommend using wires with cross-sections greater than 0.5 mm<sup>2</sup>.

#### Requirements for cable ducts

- The recesses in the housing are intended for M16 ducts.
- The ducts should have a smooth and rounded opening (to protect against bending and abrasion).
- Be careful to ensure securely fastened bending protection, which must be five times the length of the maximum cable diameter.
- The duct should include a strain relief that prevents slippage of the cable and that cannot be disengaged without a tool.
- You can order cable ducts from us as spare parts ([Spare parts and accessories](#)).

If you use another cable duct, the material must have a flammability rating of V1 or better.



**WARNING**

### During assembly

- Always disconnect the relevant system component from the power source before assembling the device or connecting it to the power supply or disconnecting it from the same. Prevent any inadvertent reactivation of the device.
- Only connect the device to the mains voltage as specified on the type plate.
- Observe the technical data and the environmental parameters.
- The connections for mains voltage and relay outputs must be laid separately from each other, to guarantee corresponding insulation between the cables. Accordingly, do not operate the device if the partition walls or terminal area covers are not present.

**NOTE**

---

### Avoiding interference voltages

The Testomat® EVO TH device requires stable and uninterrupted supply voltage. Where applicable, use a mains filter to shield the Testomat® EVO TH device from interference voltages, which may be generated for example within the network by magnetic valves or large-scale engines. Never lay the connecting cables in parallel to mains cables.



**ATTENTION**



---

### Handling may cause damage or destruction of electrical components!

If you need to open the upper door, you should take the necessary safety measures to avoid electrostatic discharge onto the components (ESD safety).

Make sure you are earthed before opening the casing.

---

### During operation

- **The device has no power switch.**  
Use an external power switch to turn the unit on and off. The switch must be installed next to the device and must be marked as power switch for the device - for example with a label.
- Ensure that the maximum electrical load capacity of the switching outputs is not exceeded, particularly for inductive loads. The power supply for the user inclusive device is secured with a 4A fuse, which means the total of all loads must not reach 4A.
- In the event of any malfunctions, immediately switch off the Testomat® EVO TH device and inform the service personnel. Never attempt to repair the Testomat® EVO TH device yourself. Doing so will invalidate the guarantee. Repairs must be performed by authorized service personnel only.



## **During cleaning**

- Only use a dry and lint-free cloth.
- Maintenance and care instructions are included in the section "[Servicing and maintenance](#)" and in the Testomat® EVO TH service manual

## **Malfunctions/repairing a defective device**

- A defective device, regardless of the guarantee period, can be serviced only when the device is dismantled and the error is described. Please also inform us of the indicator type currently in use and the measured medium. Make no changes or modifications to the device that go beyond the scope of use specified in these instructions. Doing so will void the warranty. This applies particularly to the measuring chamber, the seal of which must remain undamaged. If you send the device in for repair, please completely empty the measuring chamber and remove the indicator bottle and the drain funnel.

Before dismantling, the type of error must be noted (error number, error effect, log file of the SD card).

- Once a protective device has been triggered (safety fuse), initially try resolving the cause of error (e.g. by replacing a defective valve), before reactivating the protective device. Frequent triggering always signifies an error, which under certain circumstances may also damage the device.

## **During disposal**

- Dispose of the device in accordance with the regulations of your country.



**CAUTION**

**NOTE**

## Operating requirements

- Problem-free operation of the Testomat® device is only possible when using Heyl Testomat indicators and only within the pH range of 4 – 10.5! Using external indicators may invalidate the guarantee.
- Only operate the device within the scope of parameters specified under "[Technical Data](#)".
- For Testomat® devices used to monitor water hardness, large quantities of heavy metal ions in the hardened water may disturb the color reaction, particularly
  - Iron over 0.5 mg/l
  - Copper over 0.1 mg/l
  - Aluminum over 0.1 mg/l (brown-red color indication).
- If the test water contains more than 20 mg/l CO<sub>2</sub> (carbonic acid), erroneous evaluations cannot be ruled out. In this case, use an irrigator (e.g. optional accessory from Heyl Co.).
- The water to be measured must be clean and free of bubbles!
- The concentrations of disruptive ingredients can be determined with colorimetric TESTOVAL® test comparators from Heyl Co.
- In the event of
  - excessive carbonate hardness
  - the presence of disinfecting agents
  - the presence of silicate (used to protect pipes), the measuring chamber may become soiled, which over time may lead to erroneous evaluations
- Careful handling of the device enhances the operational safety and the service life! With this in mind, perform a visual inspection of the device at regular intervals as follows:
  - Has the expiry date of the indicator elapsed?
  - Are the hose connections of the dosing pump leakproof?
  - Is there any air in the dosing hoses?
  - Are all water connections leakproof?
  - Is the door of the device carefully closed?
  - Is the device excessively soiled?
  - Are the measuring chamber and drain channel/drain hose clean?
- Problem-free operation is contingent on regular maintenance! Maintenance and care instructions can be found in the "[Servicing and maintenance](#)" section.
- Indications of problems can be found in the "[Error messages/troubleshooting](#)" section.

## Delivery includes:

1 Testomat® EVO TH

1 plastic bag with:

- Screw cap including hole and an insert for the screw cap of the indicator bottle

1 package with:

- 1 plastic bag with
  - Drain funnel
  - 2 screws for mounting power supply unit
- Power supply

1 plastic bag with cable glands

1 User manual

### NOTE

#### Attention!

Depending on your order, you may have a device with blue or black housing. The operating instructions apply to both colours, as the functionality is the same.

## Service description

The scope of use of the Testomat® EVO TH is the automatic determination and monitoring of the residual total hardness (water hardness) in water. In the process, the required measurement scope is determined based on the selected indicator and corresponding user programming.

- Simplified menu-driven operation and programming via [backlit](#) graphic LCD.
- Based on the [selected indicator](#), determinable measurement of overall hardness (water hardness)
- Free selection of [hardness units](#) in °dH, °f, ppm CaCO<sub>3</sub>, or mmol/l
- Highly accurate measurement thanks to the use of precise piston-dosing pump
- Extended operating periods due to 500 ml indicator storage bottle
- [Analysis trigger](#):
  - Automatic interval operation  
(Interval pause can be configured from 0-99 minutes)
  - Depending on quantity, via contact water meter
  - External disruption of analysis
- Two independent [limit values](#) with adjustable switching functions as well as switching option in accordance with an adjustable number of [negative analyses](#) (Two neutral change-over contacts)
- [Logging](#) on SD card for [measurement data](#) and [notifications/alarms](#) with interim buffer for 100 measurement values and 50 notifications.

- [Import](#) and [Export](#) of settings (basic program data) with selectable filenames.
- Error history for 20 notifications
- [Firmware update](#) via SD card
- Built-in self-test with ongoing monitoring
- Optional wireless retrieval of data with special WLAN SD card
- Features for integration into process controllers:
  - [Fault signal output](#) (neutral changeover contact) with [Clear input](#)
  - [Current loop](#) 0/4 - 20 mA for analog transfer of measurement data
  - Serial [RS232](#) interface to transfer measurement data and notifications/alarms

## Available indicators for Testomat® EVO TH devices

|             |   | Parameter/indicator type |                       |                       |                       |                      |
|-------------|---|--------------------------|-----------------------|-----------------------|-----------------------|----------------------|
|             |   | Water hardness           |                       |                       |                       |                      |
|             |   | TH 2005*)                | TH 2025               | TH 2050               | TH 2100               | TH 2250              |
| <b>Unit</b> | <b>°dH</b><br>(resolution)                        | 0.05 - 0.50<br>(0.01)    | 0.25 - 2.50<br>(0.05) | 0,5 – 5,0<br>(0,1)    | 1.0 - 10.0<br>(0.2)   | 2.5 - 25.0<br>(0.5)  |
|             | <b>°f</b><br>(resolution)                         | 0.09 - 0.89<br>(0.02)    | 0.45 - 4.48<br>(0.1)  | 0,89 – 8,9<br>(0,2)   | 1.8 - 17.9<br>(0.4)   | 4.5 - 44.8<br>(1.0)  |
|             | <b>[ppm]<br/>CaCO<sub>3</sub></b><br>(resolution) | 0.89 - 8.93<br>(0.2)     | 4.5 - 44.8<br>(0.9)   | 8,9 – 89<br>(2)       | 18 - 179<br>(3.8)     | 45 - 448<br>(10)     |
|             | <b>mmol/l</b><br>(resolution)                     | 0.01 - 0.09<br>(0.01)    | 0.04 - 0.45<br>(0.01) | 0,09 – 0,89<br>(0,02) | 0.18 - 1.79<br>(0.04) | 0.45 - 4.48<br>(0.1) |

\*) Note: The component mark certificate is only valid in conjunction with indicator TH2005!

### NOTE

#### Please be careful to ensure that Heyl indicators are used!

Using external indicators may result in considerable measurement deviations or measurement errors. Damage caused by foreign particles in the area of the dosing pump, measuring chamber or valves is also possible. This may invalidate the guarantee!

At Heyl, we always strive to ensure the consistently high quality of our indicators. They are specially tailored to the requirements of our measuring devices and guarantee flawless measurement results.

## Assembly



### Hazard due to defective assembly!

- Assemble the Testomat® EVO TH device in a location shielded from drips and splashes of water, dust and aggressive substances – e.g. in a switching cabinet or on a suitable wall.



### Notes for problem-free operating procedures

- Assemble the Testomat® EVO TH device vertically and without mechanical stresses.
- Assemble the Testomat® EVO TH device in a location free of vibration.



## Assembling the Testomat® EVO TH

### Requirements for the installation site

Select an installation site at which the length of the water inlet hose can be minimized (max. 5 m)

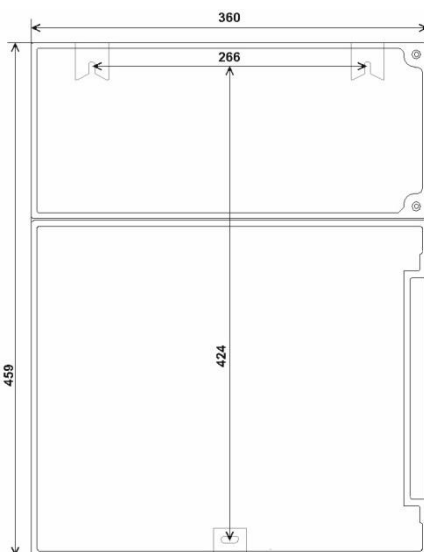

- Leave sufficient room on the left side of the device to open the door.
- Drill the mounting holes as specified in the accompanying sketches.
- Secure the device with three screws in a suitable place in the switching cabinet or on the wall.

## Use of the Testomat® EVO TH within a pressure range of 0.3 to 1 bar

Before assembling, please check whether adaptation to a lower working pressure is required. When delivered, the device is equipped for a pressure range of 1 to 8 bar. To operate the device within a pressure range of 0.3 to 1 bar, the flow governor core ② should be removed (e.g. when using a [type R mini irrigator](#)). For this purpose, take the locking pin ③ from the controller/filter housing ④. Then pull the controller plug ① on the metal brackets out of the drill hole. Then remove the flow governor core ② and re-insert the controller plug and locking pin.

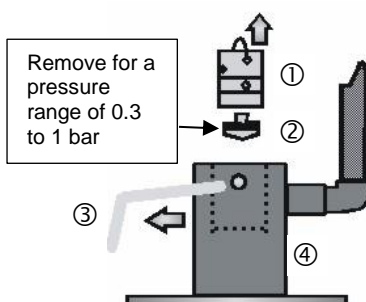

At pressures under 0.3 bar or when sucking out of a tank, our [Me-puClip booster pump](#) can be used.



## Connecting the water intake and discharge

### When using a cooler

- Water exceeding 40°C may lead to burns and may damage the parts of the Testomat® EVO TH exposed to the water.

### Notes for problem-free operating procedures

- The water pressure must be within the range 0.3 to 8 bar.
- To operate within a pressure range of 0.3 to 1 bar or when supplying via a booster pump, please remove the controller core from the controller and filter housing. The pump should have a capacity of 25 to 35 liters/hour and be correspondingly resistant to the medium being measured (e.g. our booster pump MepuClip Art. No. 270410)
- For operation exceeding 8 bar, a pressure reducer must be used.
- Significant pressure fluctuations should be avoided
- The measurement water temperature must be between 10 and 40°C
- For water temperatures exceeding 40°C, a cooler must be installed in the intake of the Testomat® EVO TH.
- We recommend short intake lines (under 3m) to the Testomat® EVO TH. For intake lines longer than 3m, purge periods of longer than 60s must be configured. For cable lengths exceeding 5 - 10m, we recommend external flushing via the AUX input.

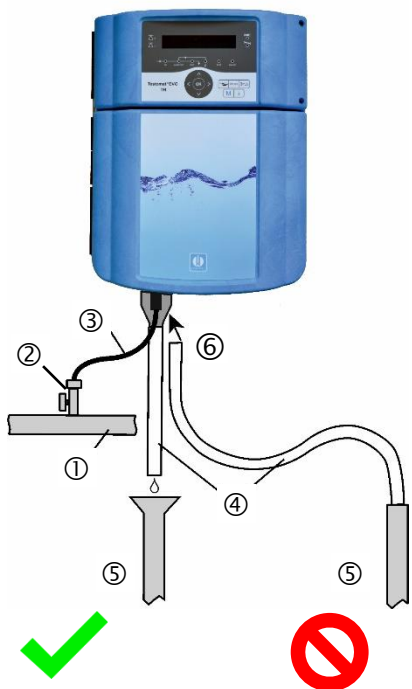

### Water intake

The test water is extracted from the sampling pipe and channelled to the supply nozzles of the Testomat® EVO TH. The device comes with a plug connection for plastic hoses 6/4 x 1 as standard (external diameter 6 mm/ internal diameter 4 mm, wall thickness 1 mm).

- Connect the linking piece for the intake of the Testomat® EVO TH directly to the sampling pipe ① directly behind the water treatment plant
- Always establish the connection vertically upwards, to prevent dirt particles from being conveyed from the sampling pipe to the device
- Assemble a manual stop valve ② in the intake to the Testomat® EVO TH
- For the water intake ③ use opaque plastic pressure hose 6/4 x 1 (max. length 5 m)
- Purge the intake to remove dirt particles

## Water drain

The water is conveyed through the measuring chamber via an open funnel ⑥ and the drain hose installed on the same and into the duct.

- Remove the supplied funnel ⑥ and accommodate it underneath, in the recess of the housing designated for that purpose.
- Connect the funnel of the Testomat® EVO TH with a drain hose ④ (internal diameter 12 mm/14 mm)
- Lay this hose **free of back pressure** and without the siphon effect to the drain ⑤

## Connect mains and devices



### WARNING

### Risk of injury from assembly when voltage present!

Unless you disconnect the power supply before commencing assembly, you risk injury, destruction of the product or damage to system components.

- Disconnect all power to the relevant system component before assembling the Testomat® EVO TH device.
- When connecting, use only verified cables with sufficient [line cross-section](#).

### Disconnecting device for the power supply

The unit has no power switch!

Fit the Testomat® EVO TH with a switch as a disconnecting device for the power supply. Use an appliance switch or a circuit breaker that meets the requirements of IEC 60947-1 and IEC 60947-3.

The switch must be within easy reach of the user of the Testomat® EVO TH and clearly marked as a disconnecting device for the Testomat® EVO TH.

For disconnection, you can also provide a three-pin plug near the device, which is clearly marked as a disconnecting device for the Testomat® EVO TH.

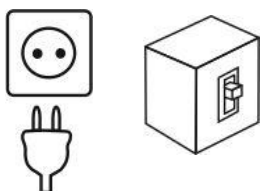

### NOTE

### Danger of damage due to electromagnetic fields!

- If you assemble the Testomat® EVO TH device or connecting cables parallel to mains cables or in the vicinity of strong electromagnetic fields, the device may be damaged or the measurement disrupted.
- Keep the connecting cables as short as possible
- Lay the connecting cables and mains cables separately.
- Connect the device with the protective conductor (at 230/100-240 VAC).
- Keep interference voltages away from the Testomat® EVO TH device – e.g. by using a mains filter.
- Shield the device from strong electromagnetic fields.

## Block diagram of Testomat® EVO TH

Illustrated position of relays: Device without current, mains: 230 V

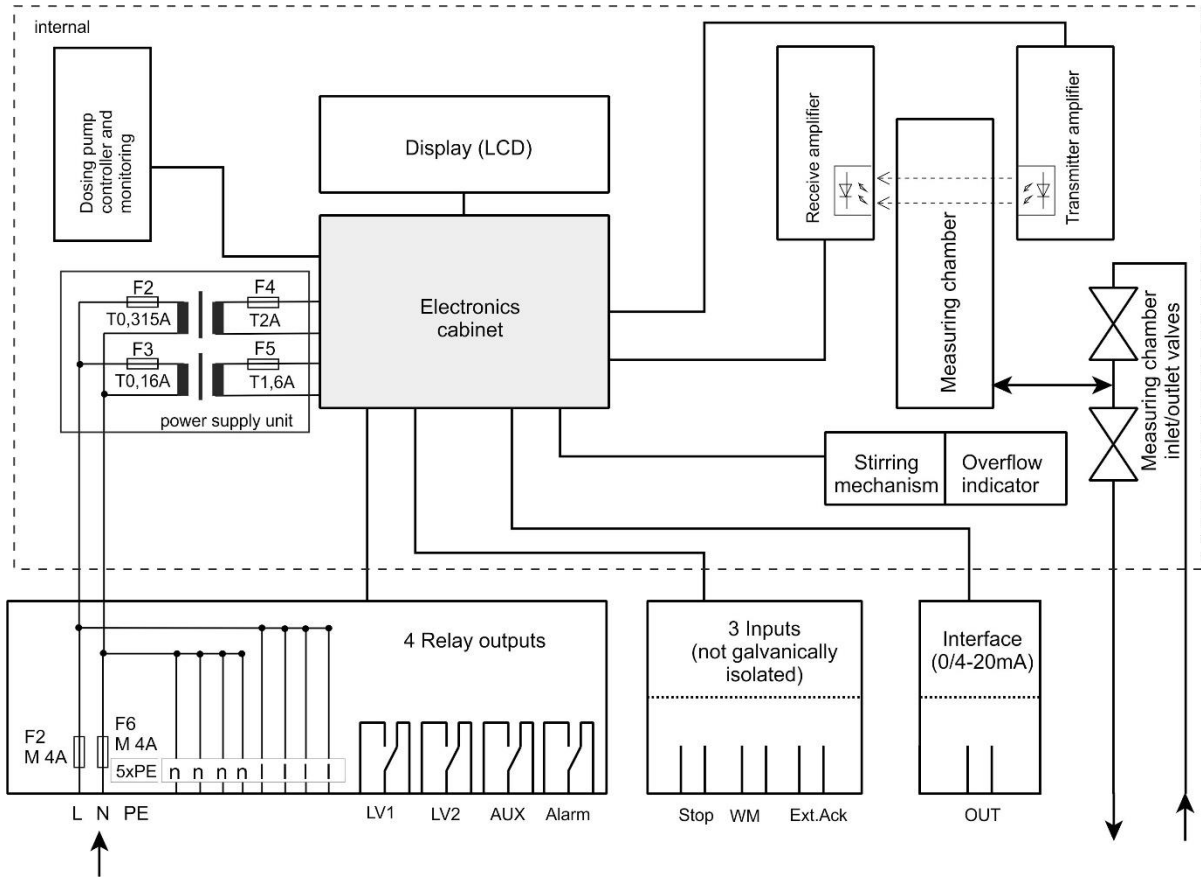



## Internal structure of Testomat® EVO TH

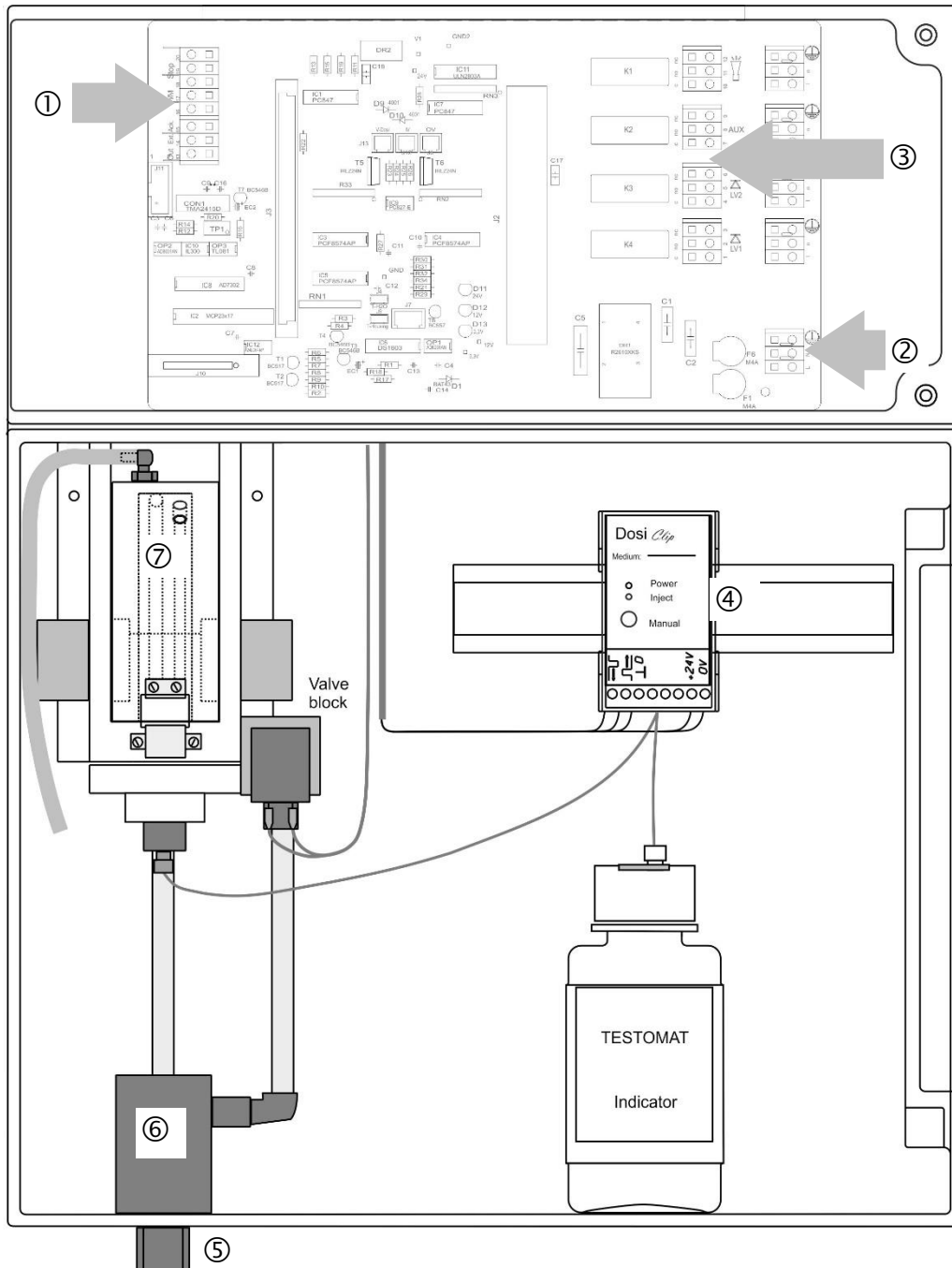

|   |   |
|---|---|
| ① | Terminal strip for <a href="#">inputs/outputs</a>           |
| ② | Terminal strip for <a href="#">mains inlets and outlets</a> |
| ③ | Terminal strip <a href="#">relay outputs</a>                |
| ④ | Dosing pump   |
| ⑤ | Water connections, intake and outlet (funnel)               |
| ⑥ | Controller/filter housing                                   |
| ⑦ | Measuring chamber   |

**NOTE**

## Cable glands

### Installing the cable glands before connecting the mains voltage!

- To prevent damage during transport, the cable glands are removed for transport. They are in a bag behind the terminal compartment cover. Insert the cable glands before connecting the unit to the mains voltage.

To guarantee IP protection, the device is supplied with cable glands and blanking plugs. If you wish to use a relay output, you must remove the blanking plug from the cable gland.

Proceed as follows in this instance:

- Loosen the strain relief of the cable gland (union nut).
- Take out the blanking plug and insert the cable.
- Tighten the union nut of the cable gland and so establish the strain relief.

## Connect mains voltage

### Installing the terminal compartment cover

For technical safety reasons, the terminal compartment cover must be put back in place immediately after connecting the mains voltage and the system components, since the terminal space houses cables that carry dangerous voltages. This helps prevent inadvertent contact with the terminals and contact between the individual lines that may carry different voltages and thus avoid the risk of a life-threatening electric shock.

**Also ensure that the cables are not pinched when installing the terminal compartment cover!**



Observe ESD safety precautions! See the information on page 8

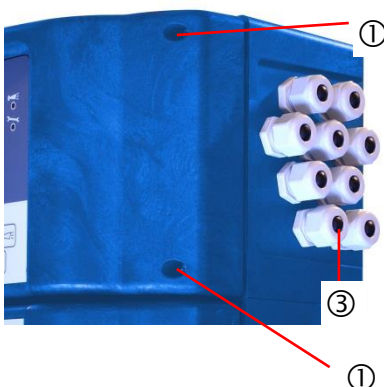

Connect the device only to the mains voltage for which it is designed. See type plate to confirm the suitable mains voltage.

To connect the cable, please proceed as described below:

- Remove both fixing screws ① and open the upper door.
- Remove the power supply board from the box at the bottom of the housing.
- Insert the power supply board into the slot on the mainboard.
- Screw in the two fastening screws at the top and bottom of the mainboard.
- Remove the fixing screw of the terminal cover and then remove the terminal cover itself.
- Lay the cable through the cable glands provided for that purpose. ③
- Tighten the union nut of the cable glands and so establish the strain relief.

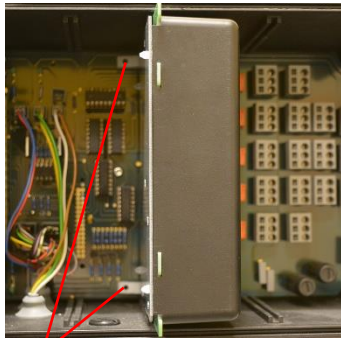

②

- Connect the supply voltage to the terminals PE,N,L or, for 24 V devices, to U and V terminals.
- Ensure that the cores in the terminals are securely in place.
- Install the terminal compartment cover.

| Terminal designation         | Type | Function   | Note   |
|------------------------------|------|--|--|
| <b>Mass/PE</b>               | IN   | Mains protective conductor (5x)  | Only for mains supply of 230 V and 100 – 240V!   |
| <b>N (U)</b><br><b>L (V)</b> | IN   | Grid, N=Neutral conductor (U=24V)<br>Grid, L=Phase (V=24V)             | Power input 50-60 Hz<br>24 V / 100-240 V / 230 V |
| <b>n</b><br><b>l</b>         | OUT  | Neutral conductor, secured with 4A (4x)<br>Phase, secured with 4A (4x) | Mains or 24V for consumers, max. 4 A             |

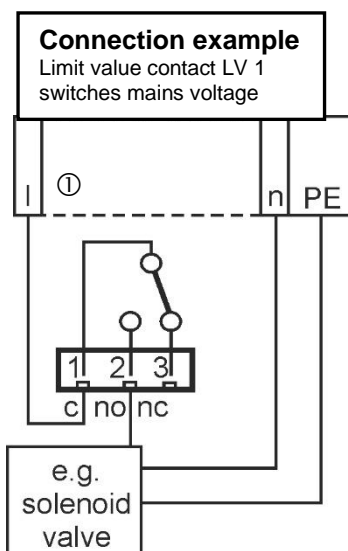
### Connect system components

- Take out the blanking plugs of the corresponding cable glands.
- Push through the cable of the component.
- Tighten the union nut of the cable gland and so establish the strain relief.
- Connect the system components to the output terminals of relays 1 to 4 (e.g. valves)
- If the system components require mains power, connect the external switched mains voltage (I) to the root contact ① of the respective relay (see accompanying connection example for 230 VAC)
- Connect the neutral conductor of the system component with one of the terminals (n)
- For components with a protective conductor connection, connect them to the PE connection.
- Ensure that the cores in the terminals are securely in place (Illustrated position of relays: Device without current, mains: 230 V)



**Indicate external voltage on the relay contacts!**

If you connect system components that do not operate using the device voltage, you can apply external voltages to the relay contacts. This external voltage cannot be switched off via the external mains switch.

**There is a danger of electric shock!**

Affix a warning to the device in this case (e.g. a sticker as shown left).

| No.            | Terminal designation             | Type | Function  | Note                                     |
|----------------|----------------------------------|------|---|--|
| 1<br>2<br>3    | <b>LV1</b><br>(limit value)      | OUT  | Limit value output 1 – root c<br>Limit value output 1 – closing contact NO<br>Limit value output 1 – break contact NC | Floating relay output, max. 240 VAC, 4 A |
| 4<br>5<br>6    | <b>LV2</b><br>(limit value)      | OUT  | Limit value output 2 – root c<br>Limit value output 2 – closing contact NO<br>Limit value output 2 – break contact NC | Floating relay output, max. 240 VAC, 4 A |
| 7<br>8<br>9    | <b>AUX</b><br>(auxilia-<br>ries) | OUT  | Function output – root c<br>Function output – closing contact NO<br>Function output – break contact NC                | Floating relay output, max. 240 VAC, 4 A |
| 10<br>11<br>12 | <b>Alarm</b>                     | OUT  | Fault signal output – root c<br>Fault signal output – closing contact NO<br>Fault signal output – break contact NC    | Floating relay output, max. 240 VAC, 4 A |

|         |         |         |          |
|---------|---------|---------|----------|
| c no nc | c no nc | c no nc | c no nc  |
|         |         |         |          |
| 1 2 3   | 4 5 6   | 7 8 9   | 10 11 12 |
|         |         |         |          |
|         |         |         |          |
| l n     | l n     | l n     | l n      |

### Connect inputs and outputs

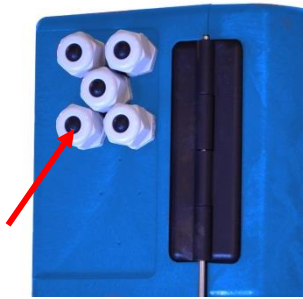

The Testomat® EVO TH device has the following sockets for control and monitoring functions. Proceed as follows for connection:

- Loosen the strain relief of the cable gland (union nut).
- Take out the blanking plugs of the corresponding cable glands.
- Push through the cable of the component.
- Tighten the union nut of the cable gland and so establish the strain relief.
- Re-secure the upper door after installation with both fixing screws.

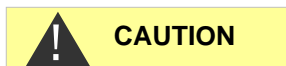

#### Correct connection of the inputs and outputs

- Do not expose the connections to any external voltage!
- Ensure that the cores in the terminals are securely in place  
Incorrect connections will damage the device!

| No.      | Terminal designation                       | Type | Function  | Note  |
|----------|--|------|---|---|
| 13<br>14 | <b>Out +</b><br><b>Out -</b>               | OUT  | Current loop 0/4 - 20 mA  | Galvanically isolated   |
| 15<br>16 | <b>Ext. Ack.</b><br>(external acknowledge) | IN   | External reset / acknowledgment input port for error and alarms | Break contact/closing contact programmable; only connect isolated break contact/closing contact |
| 17<br>18 | <b>WM</b><br>(watermeter)                  | IN   | Water meter intake<br>Common ground for inputs                  | Only connect isolated break contact/closing contact or observe the technical data of the meter! |
| 19<br>20 | <b>Stop</b>                                | IN   | External disruption of analysis<br>Common ground for inputs     | Only connect isolated break contacts/closing contacts!  |



A detailed description is included in "[Description of signal inputs/outputs](#)".

### RS232 interface terminal assignment

1 2 3 4 5  
 0 0 0 0 0

Sub-D 9 poles

0 0 0 0  
 6 7 8 9

| No. | Terminal designation | Function                         |
|-----|----------------------|----------------------------------|
| 2   | RXD                  | Data reception                   |
| 3   | TXD                  | Output of measured values/alarms |
| 5   | GND                  | Ground                           |

**CAUTION**

## Connect indicator bottle

Flawless operation of the Testomat® EVO TH device is only guaranteed when Heyl Testomat 2000® indicators are used! The use of external indicators may invalidate the guarantee.

### Insert indicator bottle

- Open the lower housing door by pulling on the right side
- Remove the closing cap of the indicator bottle
- Remove the plastic bag from the inner side of the lower housing door. It contains the screw cap with hole ① and the insert ② for the screw cap
- Join the parts together as shown below
- Screw the hose connector ③ of the suction hose ④ hand-tight into the insert ②
- Plug the insert with screwed-in suction hose into the indicator bottle
- Now screw the screw cap with hole ① hand-tight onto the indicator bottle ⑤

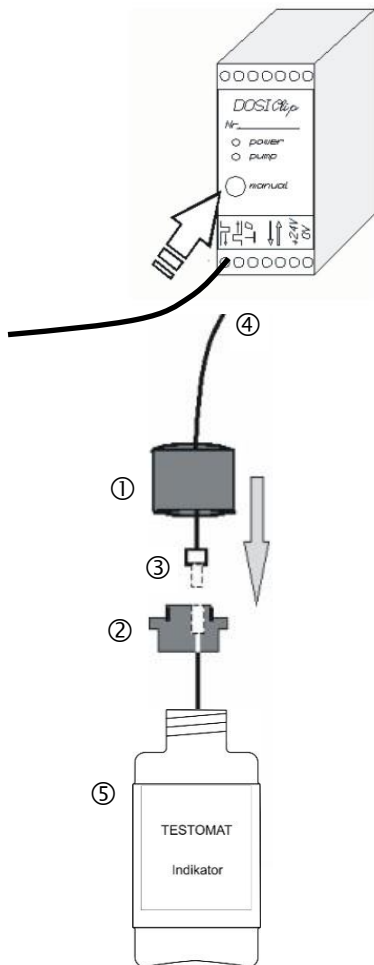

### Open water intake

- Open the lower housing lid
- Slowly open the manual stop valve to prevent the measuring chamber from overflowing. Configuring the flow regulator will take some time during the initial commissioning.
- Check the leakproof quality of water-conveying parts
- If any water sprays out of the hose ⑥ of the measuring chamber ⑦, restrict the water intake to some extent with the manual stop valve. The measuring chamber should be filled within two to six seconds!

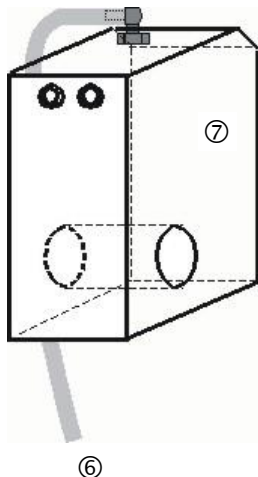

### Automatic venting

After the device is switched on the indicator lines are automatically vented and the measuring chamber purged, until indicator is detected in the measuring chamber. The automatic venting cannot be interrupted. Wait until the venting process has ended and acknowledge the "voltage failure" error message by pressing the horn key. The device is then ready for use.

## Device settings and data input

- Before you configure the required settings and inputs to facilitate operation of the device, please read the following information.

## Functions of the control and display elements

The operating modes and measurement values are shown on the display of the Testomat® EVO TH. The input keys for the programming (cursor block) and function keys are underneath the display.

### Switching the Testomat® EVO TH device on/off

(1) External power switch

Use the external power switch to switch the device on or off

(2) Device fuse (internal)

These fuses protect the device or outputs against overload and short circuit.

Descriptions of the fuses are found in [Replacing fuses](#) and under [Spare parts and accessories for the Testomat® EVO TH](#).

**NOTE**

---

#### Switching on/off

Wait at least five seconds after switching off before switching back on.

---



## Display functions

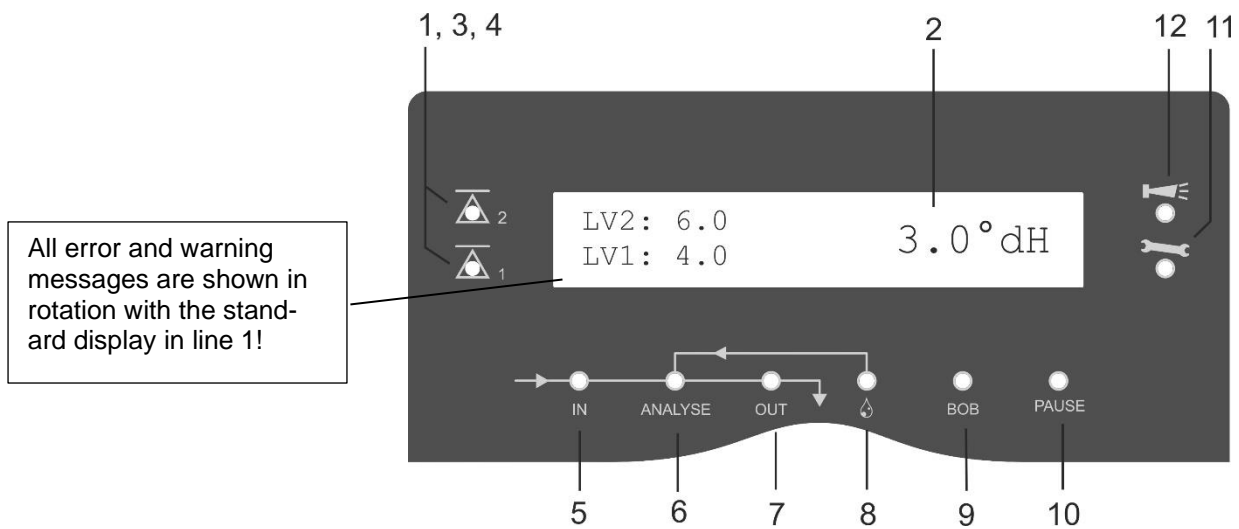

### 1 Limit value status indications (red/green)

When the limit values 1 are exceeded, indicator 1 lights up in red. Falling under the limit value results in the indicator 1 lighting up in green. The same function applies to limit value 2 and indicator 2.

### 2 Display

The current analytical result is shown as well as all important states and programming data

The current measurement value appears on the right

The configured limit values LV1 and LV2 appear on the left. When the measurement range is exceeded = "<" e.g.: < 0.05 °dH

Exceeding of the measurement range = ">" e.g.: > 10.0 °dH

The current analysis interval is suspended (analysis stops) and the LED "Pause" flashes.

### 3 LV2 (red/green)

### 4 LV1 (red/green)

An LED lit up in green indicates that the limit value has been exceeded.

The LED lit up in red indicates that the limit value has been exceeded.

### 5 In (green)

The green LED indicates an opened inlet valve.

### 6 Analysis message (yellow)

The yellow LED indicates ongoing analysis.

### 7 Out (green)

The green LED indicates an opened outlet valve.

### 8 Dosing (yellow)

The yellow LED indicates the activated dosing pump.

### 9 "BOB operation"

The green LED indicates the activated BOB operation.

**10 Pause (green)**

The flashing LED indicates the activated pause.

**11 Service (yellow)**

The yellow LED indicates that the maintenance period has elapsed.

**12 Alarm (red)**

Indicates a functional error/error message or warning message.

**NOTE**

**Handling of error messages/warning messages**

- Eliminate the cause of the error and then acknowledge the message with the "Horn" button



**Control and function keys**

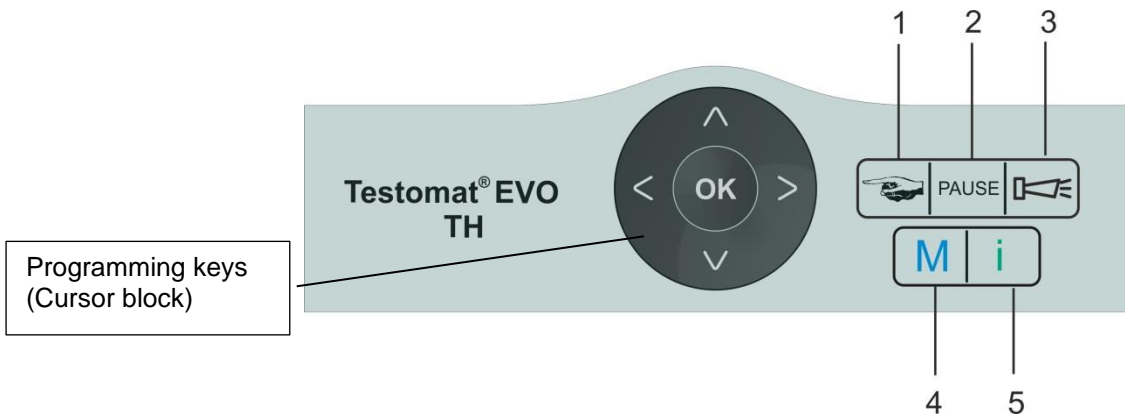

| Function keys |  |
|---------------|--|
|               | The <b>"Manual"</b> button (1) is used to start manual analysis  |
|               | The <b>"PAUSE"</b> button (2) puts the device into standby mode (no automatic analysis performed: analysis stop). However, an ongoing analysis will not be suspended. The device only reverts to pause mode once the analysis is complete. |
|               | Acknowledge error and warning messages with the <b>"horn"</b> button (3)   |
|               | The <b>"M"</b> button (4) is used to access the programming menu for user- and device-specific settings  |
|               | The <b>"i"</b> button (5) is used to access all device information and settings  |



### Input programming data

If you configure settings or wish to input data or when changes are required, you can call up the programming menu with the "M" button. Pressing this button *in the menu* brings you to the higher-level menu item or you can leave the programming menu.





### Programming keys (Cursor block)

The following programming keys (cursor block) are used to navigate in the menu, select the desired functions and input the required device- and system-specific data. The "OK" button is used to select the submenu option and allows the selection or data input to be confirmed and adopted.

### Indicator of the selected settings

If only one entry from a choice of multiple entries can be selected from within a menu, a "\*" symbol is shown. For all other entries, nothing is shown. Example: Configure indicator

If multiple entries from within a menu can be selected, a "√" is shown, or "-", for each of the active settings.

If inputting numbers is possible, the cursor keys   are used to change the position and the buttons   to change the value.

Whatever the situation, to be adopted all entries must be confirmed with "OK".

## Operating system

### Meaning of the symbols in the menu





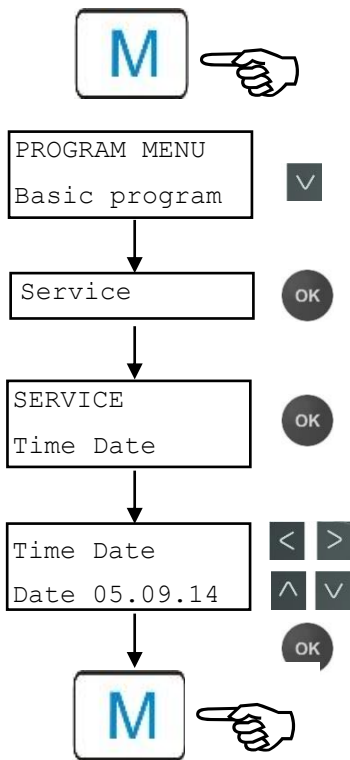

In the menu, symbols are shown on the first line at the right-hand edge. These represent the function keys, which can be used to facilitate navigation at this point in the menu.

| Symbol | Meaning  |
|--------|--|
| M / I  | "M" button, "I" button: Indicates the current menu (basic program/service or information                                     |
| ▲<br>▼ | Down or up arrows indicate that an additional selection option is available over or under the current menu option shown.     |
| ◀▶     | Right or left arrows mean that settings can be viewed with the cursor keys, for example individual errors in the error list. |
| +      | A "Plus" means that the selected menu option includes an additional submenu.   |



**NOTE**

**Inputting date and time**

- Press the "M" button  
The following selection appears: "Basic program" or "Service"
- Using the cursor block , select the menu option "Service"
- Confirm your selection with "OK"
- Using the cursor block   select the desired menu option for "Time Date"
- Confirm your selection with "OK"
- Move the cursor with the   buttons to the desired position in the time/date field
- Select the desired figure by confirming with the cursor keys  
- Confirm the newly configured values for the time and date with "OK"  
If you do not wish to change the values, press no buttons for 30 seconds. The device will then revert back to the values in the operating display.
- Press the "M" button to leave the levels.

---

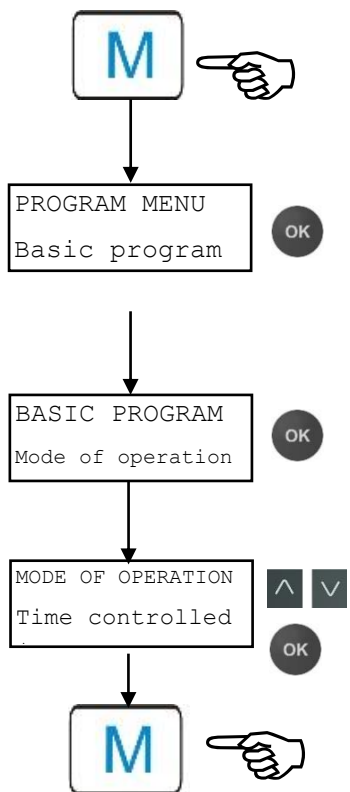

The clock continues to run even if the device is switched off.

---



**NOTE**

**Selection of functions (Example: "Select mode of operation")**

- Press the "M" button  
The following selection appears: "Basic program" or "Service"
- Confirm "Basic program" with "OK"
- Confirm the menu option "Mode of operation" with "OK"  
The following selection appears: "Time controlled", "Volume interval" or "Volume and Time"
- Select the desired function by confirming with the cursor keys  
- Activate the function with "OK"  
(With an active function, an " \* " appears at the end of the line)  
This activates the selected function.
- Press the "M" button to leave the levels.

---

If you have activated one function, the others are automatically deactivated.



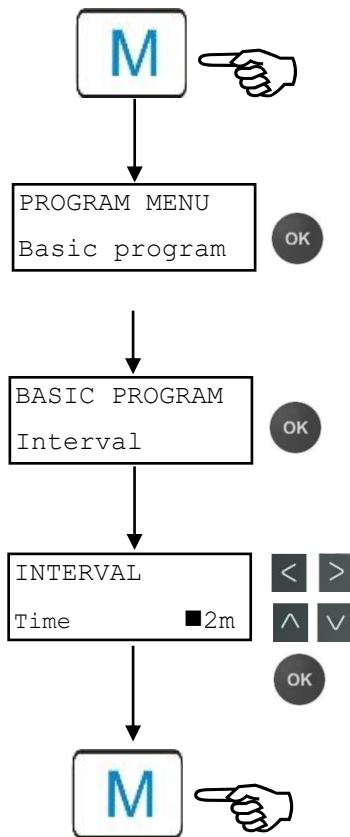





---



**Inputting of data** (Example: interval pause/quantity interval)

Using the menu option "Interval" you can program the interval pause between two analyses.

To adjust the interval pause, proceed as follows:

- Press the "M" button  
The following selection appears: "Basic program" or "Service"
- Confirm "Basic program" with "OK"
- Select the menu option using the cursor block    
"Interval"
- Confirm your selection with "OK"  
The following selection appears: "Time" or "Volume"
- Now confirm the menu option "Time" with "OK"  
The cursor flashes on the first digit of the time setting: "■2"  
(You can input values from 0 to 99 minutes)
- Confirm with the cursor keys   to select the desired digit for the first position
- Move the cursor with the   buttons to the second input field
- Confirm with the cursor keys   to select the desired digit for the second position
- Now confirm the input with "OK"

The input of the time interval is now complete.

When inputting the quantity interval, proceed when selecting the menu option "Volume" similarly as to when setting time.

- Select the four digits in sequence.
- Confirm with "OK".  
You can enter values from 1 - 9999 liters.
- Press the "M" button to leave the levels.

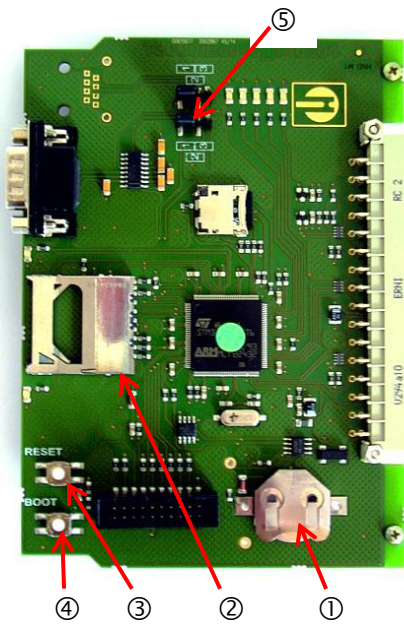

## Control elements on the control board

- **Battery holder ①**: The battery holder houses a CR2032 lithium battery to retain the time setting even if the device is switched off.
- **Plug-in slot for SD card ②**: SD or SDHC cards with a maximum capacity of 32GByte are suitable. The card must be FAT or FAT32 formatted.
- **RESET button ③**: To reset the controller, proceed as for switching on and off
- **BOOT button ④**: Only used when a menu-driven firmware update is not possible.
- **Jumper field ⑤**: Both jumpers must be plugged into the marked Position 1. All other positions will render the serial interface unusable.

## Mounting the SD card

### Inserting the WLAN SD card

If the optional WLAN SD card is used for wireless access, please observe the operating instructions in the User manual that accompanies the card.

- Slide the SD card into the plug-in slot provided, as shown in the diagram.
- Gently press in the SD card until it audibly clicks into place. The process of mounting the SD card is now complete.

### Status displays of the SD card

| LED yellow | LED red | Meaning  |
|------------|---------|--|
| On         | Off     | Read access on the SD card underway                                    |
| Off        | On      | Writing process underway   |
| On         | On      | SD card error has occurred (also shown as text alert in the indicator) |

Further information on possible errors is included in the section [Error messages/troubleshooting](#). How and whether these errors are shown can be configured in the [Alarm/message](#) menu.

### NOTE



Observe ESD safety precautions! See the information on page 8

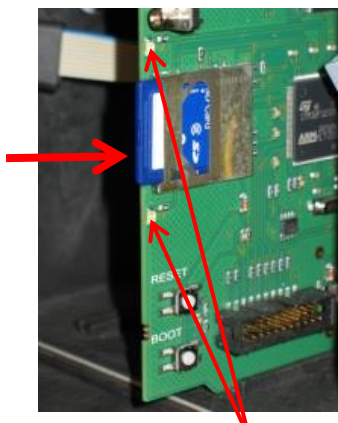

LEDs of the SD card

## Getting started

Once you have completed the steps in the section [Connecting indicator](#), you can switch on the device.

### NOTE

#### Automatic venting

After the device is switched on the indicator lines are automatically vented and the measuring chamber purged, until indicator is detected in the measuring chamber. The automatic venting cannot be interrupted. Wait until the venting process has ended and acknowledge the "voltage failure" error message by pressing the horn key. The device is then ready for use.

You can skip automatic venting by keeping the OK button pressed when switching on.

Since no settings in the programming menu can be configured while the analysis is underway, press the **PAUSE** button once the venting is complete or proceed to the programming menu before the first analysis starts!

- Now make the following settings, since these are imperative for obtaining usable measurement values:
  - Select [Indicator type and container size](#)
  - Select display [unit of measurement values](#)
- Now perform the first measurement by pressing the button  Upon completion of the analysis, a measurement value must be shown. If any error occurs, please refer to the section on [Error messages/troubleshooting](#) and resolve the error.

Once the first analysis has been successfully completed, you can adapt the device to your desired usage. The following sections will set out all the configuration options.

# Input basic programming data

**NOTE**

## Delayed reaction

During analysis, the response to any key presses may be delayed.

## Select operating mode

Under the menu option "Operating mode" you can select the type of analytical control. The Testomat® EVO TH gives you scope to control timing or quantity via water meter or a combination of both.

**Timing control**  
Internal trigger by timer.

Smallest pause interval = 0 minutes between analyses. Longest pause = 99 minutes.

The analysis interval (interval between two analyses) is determined by the configured purge cycle, the programmed pause time (interval) and the duration of analysis. The duration of analysis is **directly** dependent on the measurement value.

|                   |   |
|-------------------|---|
| MODE OF OPERATION |   |
| Time controlled   | * |
| Volume interval   |   |
| Volume and Time   |   |

## Select timing control

- Select in the menu => Basic program=> Mode of operation => Time controlled
- Confirm the selection with "OK"  
(An "\*" appears at the end of the line)  
(The factory default is "Time controlled" "\*")
- Now enter the [interval](#).

**Quantity control**  
Triggered by water meter

## Select quantity control

Smallest interval = 1 liter, largest interval = 9999 liters. The analysis is performed once the programmed quantity of water has passed. Before the analysis, the line and measuring chamber are purged (observe programmed purge cycles).

|                   |   |
|-------------------|---|
| MODE OF OPERATION |   |
| Time controlled   |   |
| Volume interval   | * |
| Volume and Time   |   |

|          |       |
|----------|-------|
| INTERVAL |       |
| Time     | 10m   |
| Volume   | 03501 |

- Select in the menu => Basic program => Mode of operation => Volume interval
- Confirm the selection with "OK"  
(An "\*" appears at the end of the line)
- Select in the menu => Basic program => Interval => Volume
- Confirm the selection with "OK"
- Input the corresponding flow volume in liters
- Confirm the input with "OK"
- Now select the [water meter](#) .



**Quantity control  
Time priority**

|                   |   |
|-------------------|---|
| MODE OF OPERATION |   |
| Time controlled   |   |
| Volume interval   |   |
| Volume and Time   | * |

|          |       |
|----------|-------|
| INTERVAL |       |
| Time     | 10m   |
| Volume   | 03501 |

### Select quantity control/time priority

The analysis is performed once the programmed quantity of water has passed. An analysis is always prioritized once the programmed interval pause has elapsed.

#### Select the function

- Select in the menu => Basic program => Mode of operation => Volume and Time
- Confirm the selection with "OK"  
(An "\*" appears at the end of the line)
- Select in the menu => Basic program => Interval => Time
- Confirm the selection with "OK"
- Select the pause time in minutes with the cursor keys.  
(The factory default setting is 10 minutes)
- Confirm the input with "OK"
- Select Volume with the cursor keys
- Confirm the selection with "OK"
- Input the corresponding flow volume in liters
- Confirm the input with "OK"

### Configure interval (interval pause)

With time-controlled analysis trigger, the interval between two analyses is determined by the interval pause (plus purge cycle). The shortest possible interval pause is 0 minutes. Non-stop analyses are then performed. The largest interval is 99 minutes.

- Select in the menu => Basic program => Interval => Time
- Select the pause time in minutes with the cursor keys.  
(The factory default setting is 10 minutes)
- Confirm all entries with "OK"

|          |       |
|----------|-------|
| INTERVAL |       |
| Time     | 10m   |
| Volume   | 00001 |

**NOTE**

#### Duration of the analysis interval

The time for the analysis interval comprises the cumulative time taken for the "Analysis interval", "Purge" and the duration of analysis, which depends on the measurement value (see accompanying diagram).

When you perform additional purging via the AUX relay before or after the analysis, the duration of the analysis interval will be extended accordingly.

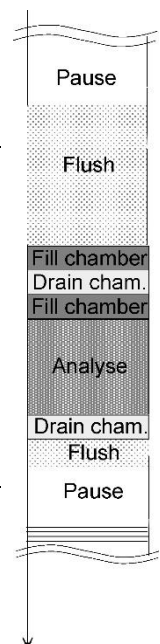

## Select indicator type and container size

|              |   |
|--------------|---|
| BOTTLE SIZE  |   |
| 500ml bottle | * |
| 100ml bottle |   |

- Press the "M" button  
This brings you to the basic menu for "Basic program"
- Confirm "Basic program" with "OK"
- Keep pressing the  button until the menu option "Bottle size" appears.
- Confirm this menu option with "OK"  
You have the following selection.
- Select the quantity of indicator  
(The factory default setting is the 500 ml bottle " \* ")
- Confirm the selection with "OK".  
(An " \* " appears at the end of the line to indicate the selection)
- Press the "M" button
- Select the menu option "Type of reagent"
- Confirm with "OK"  
You have the following selection
- Select the indicator type  
(The factory default setting is the indicator type TH2005 " \* ")
- Confirm the selection with "OK"  
(An " \* " appears at the end of the line)  
The " \* " indicates the selection.

|                 |   |
|-----------------|---|
| TYPE OF REAGENT |   |
| Type TH2005     | * |
| Type TH2025     |   |
| Type TH2050     |   |
| Type TH2100     |   |
| Type TH2250     |   |

The indicator selection is now complete.

## Select measurement value unit

You can program the unit of the value shown. Your selection options include °dH, °f, ppm CaCO<sub>3</sub> as well as mmol/l. All the following inputs and indications will then be shown in the programmed unit.

|                   |   |
|-------------------|---|
| DISPLAY OF UNIT   |   |
| Display °dH       | * |
| Display °f        |   |
| Display ppm CaCO3 |   |
| Display mmol/l    |   |

- Select in the menu =>Basic program=> display of unit
- Select the desired unit  
(The factory default setting is the °dH unit)
- Confirm the selection with "OK"

## Limit value monitoring

You can program the limit values to be stepless. The limit value range is specified by the indicator type and programmed unit used. You can monitor two limit values. For this purpose, each limit value output is available. The functions of the assigned delay outputs can be programmed independently of each other.

Monitoring of  
two limit values

The limit value outputs are permanently assigned to limit values! (GW1/2 are available on the LV1/2 terminals.)



LV1 = limit value 1



LV2 = limit value 2

If the limit value LV1 is exceeded, the limit value control indicator lights up in RED and the relay output LV1 responds according to the programmed switching function. If the limit value has not been exceeded, the indicator lights up in GREEN. The same functional approach applies to the limit value LV2.

### Entering the limit values

- Select in the menu => Basic program => limit values
- Input the values for "LV 1" or "LV 2"
- Confirm the input with "OK"

|              |          |
|--------------|----------|
| LIMIT VALUES |          |
| LV1:         | 0.25 °dH |
| LV2:         | 0.15 °dH |

## Input operating mode of LV1 and LV2 limit value outputs

|                  |   |
|------------------|---|
| FUNCTION LV1/LV2 |   |
| Limit value      | * |
| Two point        |   |
| Range            |   |

- Activate the operating mode for **both** relays via  
=> Basic program => Function LV1/LV2

The following operating modes can be configured:

### Limit value operating mode

A limit value may be defined for both relays. The relay switches when the limit value is exceeded.

### Two-point operating mode

(Output LV2 relay as a two-point controller)

If the LV2 upper limit value is exceeded, the LV2 output relay is activated. If the lower limit value LV1 is not attained, the LV2 relay is switched off. Different values must accordingly be set for the limit values LV1 and LV2. For example, for LV1 = 0.1 °dH and LV2 = 0.2 °dH.

The Output LV1 relay works independently as a limit value relay and is activated once the LV1 limit value is exceeded.

- For each relay, the switching function included via  
=> Basic program => Relay LV1 or Relay LV2  
can be separately configured:

### Operating mode range

The relays switch when the predefined range between LV1 to LV2 is exited:

- If GW1 is not attained, relay 1 switches
- If GW2 is exceeded, relay 2 switches

### Switching functions of the LV1 and LV2 limit value outputs

|            |         |
|------------|---------|
| RELAY LV1  |         |
| Hysteresis | 1       |
| Duration   | *       |
| Impulse    |         |
| Interval   |         |
| Time       | 00m:10s |

- Input the switching function **separately** for each relay via  
=> Basic program => Relay LV1 or Relay LV2
- Select Hysteresis, Duration, Impulse, Interval and Time.  
(An "\*" appears at the end of the line)
- Input the time (only with impulse and interval switching function)  
(Values from 00:00 up to 99 min. and 99 sec. can be entered)
- Confirm the input with "OK"

#### Switching function only after multiple exceeding of limit value

The respective limit value output can be set to be triggered after the first, second or third exceeding of the limit value.

This improves the assessment of the analysis e.g. after possibly insufficient purging of the sampling line.

The value may be separately configured for both the LV1 relay and LV2.

The basic setting is 1 for LV1 and LV2. Switching occurs immediately after the limit value is exceeded, with no delay.

When the number of times the limit value has been exceeded is "2", the next analysis is performed immediately after the first exceeding of the limit value. Only after the limit value has been exceeded twice is the corresponding output switched.

When the limit value has been exceeded "3" times, the corresponding output only switches after the limit value has been exceeded three times consecutively. This setting is only reactivated once the reading falls under the limit value!

#### Switching function duration

If the limit value LV1 or LV2 is exceeded, the output LV1 relay or LV2 switches. If the limit value LV1 or LV2 is not attained, the corresponding relay is again deactivated.

#### Switching function impulse

If the LV1 or LV2 limit value is exceeded, the corresponding output switches for the set time (t).

Regardless of the duration for which the limit value is exceeded, the corresponding output remains always switched for the set time. A renewed impulse is possible only once the reading falls under the limit value!

Diagram of the switching functions

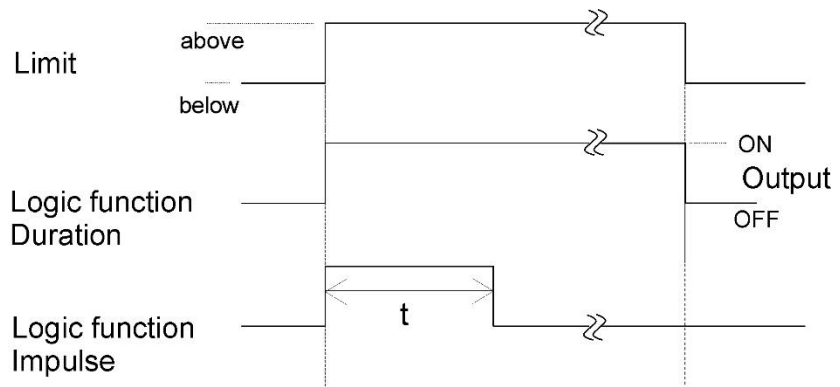

Mode of operation:      above upper limit  
 Two point                -> output LV2 pulls up  
 (upper limit only)      below lower limit  
                                  -> output LV2 drops out

### Input purge cycle

To guarantee that the sample being analyzed is current, the sampling line must be sufficiently purged over its entire length. When the system is unused for an extended period and when the analysis interval is considerable, a purge cycle of more than 60 seconds should be selected. The purging is performed by simultaneously opening the inlet and outlet valves of the Testomat® EVO TH.

**NOTE**

#### Duration of the analysis interval

The analysis interval depends directly on the programmed purge cycle. If for example a purge cycle of 90 seconds is set, the analysis interval must be at least 90 seconds as well.

|                 |         |
|-----------------|---------|
| FLUSH TIME      |         |
| Time            | 00s     |
| ExceedanceFlush | 00m:00s |

#### Internally enter the purge cycle

- Select in the menu  
 Basic program => Flush time => Time
- Input in the menu option "Time" the time in seconds(s).  
 (The factory default setting is 00 seconds(s))
- Confirm all entries with "OK"

#### Enter excess

An additional purge cycle can be entered here after the limit value has been exceeded, if the internal purging is not sufficient to flush out the intake. The internal purge cycle is then extended by the set time.

- Input the time in minutes (m) and seconds (s) in the menu option "ExceedanceFlush".  
 (The factory default setting is 00m:00s )
- Confirm all entries with "OK"

|                |   |
|----------------|---|
| WATER METER    |   |
| 1 l/Impulse    |   |
| 2,5 l/Impulse  |   |
| 5 l/Impulse    |   |
| 10 l/Impulse   |   |
| 100 l/Impulse  | * |
| 500 l/Impulse  |   |
| 1000 l/Impulse |   |

## Select water meter

For quantity-based analytical trigger, a water meter must be connected to the WM **input** (WM = water meter).

- All settings are configured in the  
=> Basic program => Water meter menu.

Further information in the "[Description of the signal inputs/outputs](#)" section

## BOB operation (operation without constant supervision)

The operation without constant supervision is safety-relevant when using the device to determine water hardness and monitor steam boiler systems in accordance with TRD 604.

If the BOB function is programmed, the device continuously checks the available quantity of indicator. A calculation using the following data is performed to determine whether sufficient indicator exists for the next 72 h: purge cycles, current indicator fill level, interval pause set, and the average measurement value of the previous 10 measurements.

### BOB operation selection

- Select in the menu => Basic program => BOB
- Select "Function on"
- Confirm the input with "OK"

|                    |   |
|--------------------|---|
| BOB<br>Function on | ✓ |
|--------------------|---|

**BOB ON:** Continual checking of the remaining indicator amount. Alarm message "Indicator low" when dropping below the minimum quantity for the BOB period: BOB flashes, output ALARM is switched.

**BOB off:** No BOB function. Monitoring of remaining indicator only to ascertain minimum quantity (fill level 10%)

#### Example:

BOB period = 72 hours

Number of analyses per hour = 10

Required quantity of indicator for 72 h = 72 h x 10 analyses/h x (3 x 30) µl/analysis = 64.8 ml.

(which equates to around 13% fill level of a 500 ml bottle)

### NOTE

### Operating mode for BOB operation

In operating modes "Volume interval" and "Volume and Time" no BOB operation is possible! Select only the "Time controlled" operating mode!

## Description of the relay outputs

All relay outputs are designed as neutral contacts. This means the full range of connection options is available to you. This facilitates the switching of mains power, external power and direct switching of inputs, e.g. a process control procedure is implemented.



### Durability of relays

Please note the loading capacity of the relay and the overall loading capacity (see Technical Data)!

Excessive loading may destroy the relay.

### LV1 and LV2 limit value outputs

Two isolated relay contacts are provided to issue limit value exceeded alerts. For both contacts, the limit values, the number of times the limit value has been exceeded up to switching as well as the switching function itself are freely programmable:

**Limit value 1 (LV1)**  
Terminals 1,2,3

| Function   | Contact   | Action   |
|--|---|--|
| <b>LV1</b><br>relay switches when exceeding the limit value of limit value 1 | Isolated change-over contact<br>Terminal 1: c / Central contact<br>Terminal 2: no / closing contact<br>Terminal 3: nc / Break contact | programmable: <ul style="list-style-type: none"> <li>- Permanent contact</li> <li>- Impulse (1-99 seconds/minutes)</li> <li>- interval (1-99 seconds/minutes)</li> <li>- Area of lower limits</li> <li>- Switches when the limit value is exceeded once, twice or three times</li> </ul> |

**Limit value 2 (LV2)**  
Terminals 4,5,6

| Function   | Contact   | Action  |
|--|---|---|
| <b>LV2</b><br>Relay switches when exceeding the limit value of limit value 2 | Isolated change-over contact<br>Terminal 4: c / central contact<br>Terminal 5: no / closing contact<br>Terminal 6: nc / break contact | programmable: <ul style="list-style-type: none"> <li>- Permanent contact</li> <li>- Impulse (1-99 seconds/minutes)</li> <li>- interval (1-99 seconds/minutes)</li> <li>- Area of upper limits</li> <li>- Two-point</li> <li>- Switches when the limit value is exceeded once, twice or three times</li> </ul> |

Further explanations can be found in the section "[Operating mode of LV1 and LV2 limit value outputs](#)"!

## AUX (programmable functional output)

**AUX**  
Terminals 7,8,9

| Function  | Contact   | Action                                     |
|---|---|--|
| <b>AUX</b><br>Programmable function output dependent on the analytical sequence | Isolated change-over contact<br>Terminal 7: c / central contact<br>Terminal 8: no / closing contact<br>Terminal 9: nc / break contact | Programmable with time interval, see below |

This isolated relay output lets you set various switching functions set, which depend on the analytical sequence.

➤ Select in the menu =>basic program => Relay AUX.

|                        |         |
|------------------------|---------|
| RELAY AUX              |         |
| Before retry           | *       |
| Before analysis        |         |
| During analysis        |         |
| Before,during analysis |         |
| After analysis         |         |
| Time                   | 00m:10s |

You have the following configuration options:

- Active "Before retry": In this case the relay AUX e.g. is used to control an external purge valve. If a limit value has been exceeded, but the number set for the limit value occurrences was >1, the relay switches before each measurement is repeated. The purge procedure is performed for the set time. This can help prevent measurement errors due to insufficient purging.
- Active "Before analysis": e.g. for external purging switches the relay for the set time before each analysis.
- Active "During analysis"
- Active "Before, during analysis"
- Active "After analysis"
- In addition, it is also possible to specify a time interval for which the relay remains active.

| ALARME/MESSAGE       |   |
|----------------------|---|
| Fault dosing pump    | A |
| Fault optics         | A |
| Fault turbidity      | M |
| Fault soiling        | M |
| Fault analysis       | A |
| Meas. range exceeded | M |
| Water low            | A |
| Indicator low        | A |
| Power failure        | A |
| Power failure 24     | A |
| Ext. light influence | A |
| SD Card n. inserted  | M |
| SD Card w. protected | M |
| SD Card unformatted  | M |
| SD Card failure      | A |
| RTC bus error        | A |
| RTC data invalid     | A |
| BOB not possible     | A |
| Service exceeded     | - |

## Alarm (Fault signal output)

The device includes a relay "Alarm" output to notify faults.

A error is signaled via the LED alarm and the corresponding error message is shown on the display. You can configure whether and how this indicator should be shown.

➤ Select in the menu

=>Basic program => Alarm/Message.

➤ Select the signaling for each type of error.

You can set whether the error alerts

- are not provided at all (by selecting "-" in the menu). (Note: selection is not always available!)
- Only in the indicator (by selecting "M" for notification/message)
- In the indicator and via the relay output (by selecting "A" for Alarm)



|                                    |
|------------------------------------|
| <b>Alarm</b><br>Terminals 10,11,12 |
|------------------------------------|

### Functions of the alarm output

The "Alarm" output is an isolated relay changeover contact. During normal operation, the contact between terminals 10 - 11 is closed and opened between 10 - 12. In the event of voltage failure, the contact between terminals 10 - 12 is closed and opened between 10 - 11.

The device includes a whole range of monitoring functions with following functions/performance of the "Alarm" output:

- In the event of permanent contact, the output remains "Alarm" indefinitely activated (terminals 10 - 12 closed), pending resolution of the error.  
The prerequisite here is that, in the menu  
=> Basic program => Alarm/Message  
the signaling "A" indicating the alarm for this error type is activated.
- The fault signal at the "Alarm" output is stopped when you acknowledge the error with the "horn" button or by entering EXT. ACK. With the help of these inputs and outputs and the transmission of measurement data (via 20mA current loop or serial RS232 interface), the Testomat can be operated at a master display.
- If the limit value is exceeded, there is **no** additional Alarm via the Fault signal output!

A description of the possible causes of error is included in the section on [Error messages/troubleshooting](#).

## Alarm/message – How to proceed when errors occur

Error messages are adapted to the selected language, but can also be identified by an error number, regardless of the language used.

All errors are, regardless of the settings made in this menu option:

- stored on SD card if [Storing of error messages](#) has been activated
- recorded in the error history (the last 20 error messages)
- and sent via the serial RS232 interface.

Detailed information on possible error messages as well as their cause and remedy is found in [Error messages / troubleshooting](#).

### NOTE

#### Error messages after self-test

For error messages caused by an improperly executed self-test, no settings can be made; see [Error messages after self-test](#).



## Description of the signal inputs/outputs



**CAUTION**

### Switching of the signal inputs

- Switch the signal inputs "Stop", "WM" and "Ext. Ack" only with *isolated* contacts!  
Switching with external voltage will damage the device!

### Stop input

The stop input is intended for short-term suspension of operation, e.g. when performing renewal work on softening plants, reverse osmosis or other water treatment systems. Generally speaking, the system is not offline for more than six hours. The renewal phase of a softening plant, for example, lasts three hours at most.

**Stop**  
Terminals 19,20

| Function   | Contact type   | Testing duration | Action   |
|--|--|------------------|--|
| <b>Stop</b><br>External analysis stop (e.g. via flow monitor or process control) | Programmable:<br>break contact or<br>closing contact<br>(isolated) | None             | There are no analyses while the contact at the input is open or closed |

If stop input is active, an analysis is prevented from starting, due for example to an interval having elapsed. This may be required, if the system lacks water. However, any analysis already started will not be suspended. The analysis is completed and the device reverts to pause mode.

Manual start has priority over stop input. That means that manual analysis can still be started even when stop input is active.

While the stop signal is present, the measurement value is shown on the display and the LED pause flashes. If the stop signal is deleted, a new analysis starts immediately.

Accordingly, a short impulse on the stop input can help trigger an analysis remotely.

### Programming the "Stop input" switching function

- Select in the menu => Basic program=> Function Stop
- Select the contact type
- Confirm the selection with "OK"

|                 |   |
|-----------------|---|
| FUNCTION STOP   |   |
| Normally closed |   |
| Normally open   | * |

## External delete (external acknowledge)

**Ext. Ack.**  
Terminals 15,16

| Function  | Contact type  | Testing duration | Action                     |
|---|---|------------------|----------------------------|
| <b>External delete</b><br>Deleting / acknowledging existing errors / alarms | Programmable: break contact or closing contact (isolated) | none             | Proceed as for horn button |

Via these terminals, all error messages can be acknowledged remotely. The contact type break contact or closing contact can be set in the menu.

➤ Here select => Basic program => Ext. Ack..

## Input water meter

**WM**  
Terminals 17,18

| Function                       | Contact type                              | Testing duration | Action                                   |
|--------------------------------|---|------------------|--|
| <b>WM</b><br>Water meter input | closing contact/break contact (isolated!) | none             | Determining quantity to trigger analysis |

### Programming the water meter inputs

- Select in the menu => Basic program => Water meter
- Select the meter constant of the water meter
- Confirm the input with "OK"
- As required, configure the contact type (break contact/closing contact) of the water meter in the menu => Basic program => function WM.

|                 |
|-----------------|
| WATER METER     |
| 1 l/Impulse     |
| 2,5 l/Impulse   |
| 5 l/Impulse     |
| 10 l/Impulse    |
| 100 l/Impulse * |
| 500 l/Impulse   |
| 1000 l/Impulse  |

## Current loop 0/4 - 20 mA

**OUT**  
Terminals 13,14

| Function                                  | Connection             | Action                                     |
|---|------------------------|--|
| <b>OUT</b><br>Current loop<br>0/4 - 20 mA | Burden max.<br>500 Ohm | programmable:<br>0 - 20 mA or<br>4 - 20 mA |

**NOTE**

### Loading the current loop

The maximum load of 500 Ohm must not be exceeded!

In the event of faults and very long lines (around 20 m), the use of shielded cable is possible.

### Monitoring the measurement point

Connecting a recorder allows the analytical results to be documented. For this purpose the device includes a programmable current output.

The following example indicates the course of the current within the range of 0-20 mA.

|                        |   |
|------------------------|---|
| CURRENT INTERFACE TYPE |   |
| Type 0-20mA            | * |
| Type 4-20mA            |   |

- Select in the menu  
=>basic program => current interface type
- Select the desired current range.
- Confirm the selection with "OK"

### Calculation of output currents

Depending on the selected function, the current range available is either 0 – 20 mA or 4 – 20 mA. The resulting currents for the various measurement values are shown in the form of the following formulas.

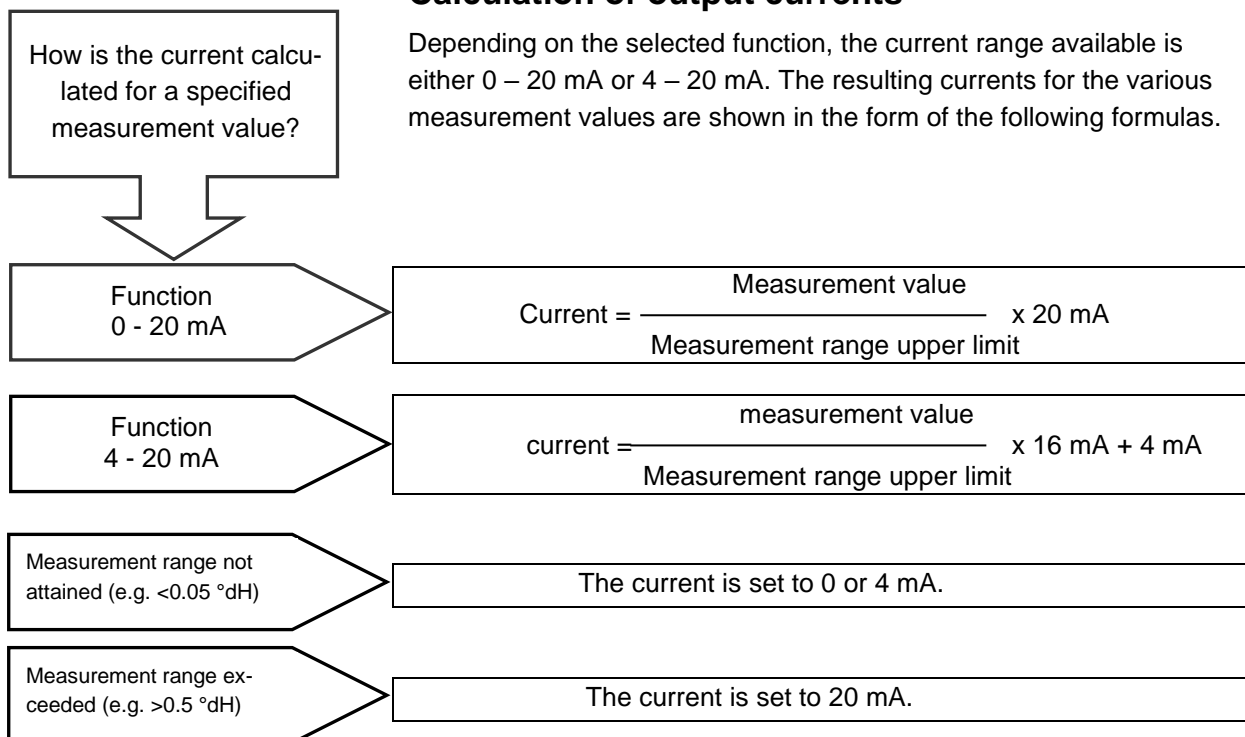

Measurement value = display value in the selected hardness unit

Maximum value = final value of the indicator used  
(e.g. indicator type 2005 = 0.5 °dH)

## Serial interface

The serial RS232 interface transfers measurement data and alarms/notifications in plain text/ASCII in CSV format. It is always active. The baud rate can be set to 2400, 9600, 19200, 38400 and 115200.

Transmission is in the 8 bit format, 1 stop bit, no parity.

A new measurement value is transmitted as soon as it has been determined.

SERIAL INTERFACE  
Baudrate

- Select in the menu  
=>Basic program =>Serial interface =>Baud rate
- Select the desired baud rate.
- Confirm the selection with "OK"

New alarms are transmitted via the serial interface and some alarms even when the alarm has been ended; see [Error messages/troubleshooting](#).

## Notification format

The notifications are sent in a very similar format as the data placed on the SD card:

- The headings are not transmitted
- Field separator is a comma
- Decimal separator is a full stop
- Each data set is started with the ASCII characters "02" <STX> and terminated with "03" <ETX>.
- Notifications and measured values can be distinguished by evaluating the first characters: If "ME" is read, it is a measured value; with "AL", it is an alarm/notification.
- This corresponds to the format of the Testomat 2000® data logger.

### Example of measured value:

```
<STX>ME,TH2005,31.07.2013,08:09,0.050,°dH,limit
val.1:;,0.200,°dH,limit val.2:;,0.300,°dH<ETX>
```

### Examples of notifications:

```
<STX>AL,Power failure,01.08.2013,06:30<ETX>
<STX>AL,turbidity,01.08.2013,07:30<ETX>
<STX>AL,turbidity inactive,01.08.2013,07:35<ETX>
```

For connection to a PC a so-called null modem cable is required.

## LCD settings

The Testomat® EVO TH comes with a large-scale backlit graphic-enhanced LC display.

- Adjust brightness and contrast in the menu =>Basic program => LCD settings

When you change a setting, brightness or contrast are adapted on the display for previewing purposes. The settings are thus not yet stored.

- Press "OK", to confirm the settings.

|              |   |
|--------------|---|
| LCD SETTINGS |   |
| Brightness   | 8 |
| Contrast     | 4 |

### NOTE

### Backlighting

There are extensive contrast adjustment options. Values between "3" and "7" are advisable here.

In the event of very warm or cold ambient temperatures, the display may no longer be optimally readable. Correct this by adjusting the brightness and contrast until the display is again readable.

## Description of the SD card functions

The SD card can be used to record measurement values and errors as well as for importing and exporting the device settings.

Error and measurement value files are separately placed in subfolders arranged by year and month:

- In the year folder, files including measurement values and errors are arranged by month.  
The format of the file names is:  
ME<Year><Month>.csv for measurement values and  
AL<Year><Month>.csv for errors/alarms.
- In the year folders, as required, subfolders are placed for the 12 months of the year, within each of which a file for measurement values and errors per day is placed.  
The format of the filenames is ME<Year><Month><Day>.csv for measurement values and AL<Year><Month><Day>.csv for errors/alarms.
- Data is stored in the "Comma-Separated-Value" format, to facilitate inclusion in spreadsheet programs and to allow it to be easily imported into databases.

**NOTE**

**Link between time and correct data**

To ensure that the naming of the file and the time and date details in the file are correct, the time function must work properly. If the [battery](#) drains, the date is automatically set to 1.1.2011, 12:00 and the data is stored. Data is not lost, since new measurement values and errors are appended to existing files. However, only one file is described in each case, since the month and day are not subject to change.

|                   |   |
|-------------------|---|
| FUNCTION SD CARD  |   |
| Store measurement | ✓ |
| Store error       | - |
| Import basic data |   |
| Export basic data |   |

**Storing measurement values**

The storing of measurement values on the SD card is activated when in the menu

=> Basic program => Function SD-Card => Store measurement

is activated.

Example for a CSV file imported into Excel:

|   | A         | B          | C     | D          | E    | F            | G           | H    |
|---|-----------|------------|-------|------------|------|--------------|-------------|------|
| 1 | parameter | date       | time  | meas.value | unit | limit        | limit value | unit |
| 2 | TH2005    | 07.06.2013 | 14:11 | 0,03       | °dH  | limit val.1: | 0,2         | °dH  |

Within the file, the comma is included as a separator in the first line "sep=", so that it can be imported directly into Microsoft Excel. If OpenOffice/LibreOffice Calc are used, this line appears after the import. It may be deleted.

**Store error**

The storing of the error on the SD card is activated, when in the menu

=> Basic program => Function SD-Card => Store error

is activated.

Example for a CSV file imported into Excel:

|                   |   |
|-------------------|---|
| FUNCTION SD CARD  |   |
| Store measurement | - |
| Store error       | ✓ |
| Import basic data |   |
| Export basic data |   |

|   | A                | B          | C     |
|---|------------------|------------|-------|
| 1 | error message    | date       | time  |
| 2 | Spannungsausfall | 07.06.2013 | 13:15 |

Within the file, the comma is included as a separator in the first line "sep=", so that it can be imported directly into Microsoft Excel. If OpenOffice/LibreOffice Calc are used, this line appears after the import. It may be deleted.



## Interim storage for a non-inserted SD card

Even if no SD card is currently inserted, no measurement values and errors are lost, since the most recently error and measurement values, which have not yet been written into storage, are saved on internal interim storage (ring memory).

As soon as an SD card is inserted, the interim stored data is transmitted during next write operation.

The capacity of this interim buffer is 50 error and 100 measurement values. After this point, the oldest values will be overwritten.

## Capacity of the SD card

The storage requirement for 10,000 measurement values amounts to around 1MByte. If error messages occur for one percent of the measurement values, a 2GB SD card for example may have around 19 million measurement values and errors.

## Export basic programming data

In the menu

=> Basic program => Function SD-Card => Export basic data

all settings of the Testomat device can be stored in a file on the SD card.

This function is recommended for:

- Storing multiple configuration profiles for one device
- Transferring settings onto other devices
- Configuring multiple devices with identical settings
- Remote maintenance / support via transfer of the basic programming data

The filename is preset to "bdata00.ini" (for "Basic Data" / basic programming data). The digits are adjustable, meaning that in total 100 different files from "bdata00.ini" up to "bdata99.ini" can be selected. The files are always stored in the root directory of the SD card.

|                   |   |
|-------------------|---|
| FUNCTION SD CARD  |   |
| Store measurement | ✓ |
| Store error       | - |
| Import basic data |   |
| Export basic data |   |

### NOTE

### Editing the file

The settings are in the file in text form and can be displayed or edited, with for example the notepad application on a PC. Use a simple text editor, not a word processor, since otherwise the formatting may be changed!

If files (for example when creating profiles) are later renamed on the PC, please note that the indicator of the Testomat device is limited to 24 characters. Longer filenames cannot be distinguished on the Testomat!

|                   |   |
|-------------------|---|
| FUNCTION SD CARD  |   |
| Store measurement | ✓ |
| Store error       | - |
| Import basic data |   |
| Export basic data |   |

## Import basic programming data

- Select in the menu  
=> Basic program => Function SD-Card => Import basic data  
one of the files in the root directory of the SD card with the ending "ini" using the arrow keys.
- Import the files with "OK".

If an error message occurs during the import, the format of the data is defective. This may occur if the file has been edited. In this case no settings are changed. Use a simple text editor for editing (e.g. Word-Pad), not a word processor, since otherwise the formatting may be changed!

All device settings are imported except

- Language settings
- Operating hours counter
- Indicator fill level
- Password

## Password protection

For data input and settings in the basic program, a four-digit password can be used. If you have forgotten your password, please contact your Heyl Neomeris service partner or water supplier.

### Password input

- Press the "M" button  
This brings you to the basic menu for "Basic program"
- Confirm "Basic program" with "OK"  
The cursor flashes in the "PW: ■000" field.
- Use the cursor keys to input the sequence of digits and confirm with "OK".  
You then see the selection menu for the basic programming.

|               |      |
|---------------|------|
| BASIC PROGRAM |      |
| PW:           | 0000 |

**NOTE**

---

### No export of passwords

Please note that in [Exporting settings](#), the password is *not* saved!

---

|                 |      |
|-----------------|------|
| CHANGE PASSWORD |      |
| Old:            | 0000 |
| New:            | 0000 |

## Change password

In the menu

=>Basic program => Change Password

the password can be set. For this purpose, the existing four-digit password code must be input, before the new code, which includes four digits, can be input.

The default password on delivery is 0000.

|                     |      |
|---------------------|------|
| PASSWORD PROTECTION |      |
| Active:             | -    |
| PW:                 | 0000 |

## Password protection

In the menu

=>Basic program => Password protection

the set password can be activated. For this purpose, the existing four-digit password code must be input first.

|                 |  |
|-----------------|--|
| FIRMWARE UPDATE |  |
| Execute (OK)    |  |



Observe ESD safety precautions! See the information on page 8

## Firmware update

### Menu-driven firmware update

In the menu

=> Basic program => Firmware update

the operating software of the Testomat device is updated. For this purpose, you need an SD card.

Implement the firmware update as follows:

- Download the firmware update for the Testomat® EVO TH from the Heyl website and save it in the root directory of the SD card to be inserted into the Testomat® EVO TH
- Insert the SD card into the Testomat® EVO TH
- Select in the menu  
=> Basic program => Firmware update
- Confirm the selection with **"OK"**
- Select the filename of the update. If only one file exists, only confirmation is required.
- Confirm the selection with **"OK"**

The Testomat restarts and implements the update. In this mode, although no text is output, the status is indicated via the LEDs of the SD card as well as those on the control card.

### NOTE

**During the firmware update, the red LED lights up next to the SD card plug-in slot (which indicates that the so-called bootloader is active).**

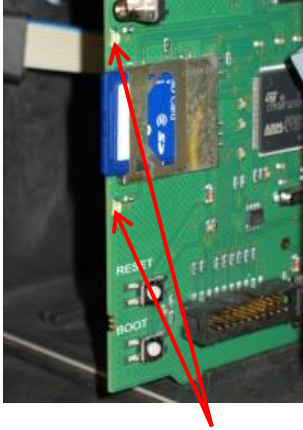

LEDs of the SD card

#### NOTE

The programming progress is indicated as bars with five LEDs on the control card:

Initially, only LED1 flashes (in the vicinity of the plug connector to the motherboard) slowly (once every two seconds) and later permanently, whereupon the next LED begins flashing. The process is repeated until all LEDs light up permanently.

The firmware update is now complete. The Testomat is started automatically with the new operating software. The complete firmware update takes around 70 seconds.

#### Possible errors:

- If *both* LEDs flash or light up next to the SD card, there is a problem with the SD card itself. The update could not be started. The existing firmware remains unchanged.
- If the LEDs next to the SD card are inactive, but the LEDs on the control card flash quickly (10x per second), an error has occurred during the update.
- See [Firmware update error messages](#).

---

#### Obtain the settings after the firmware update

After a firmware update, the device may be in an undefined state. After a firmware update, basic programming should therefore always be performed. If the settings have been preserved, it is advisable to export the settings onto the SD card before the firmware update and after the firmware update, to import the saved settings

#### Passwords

The set password is preserved even after the firmware update.

#### Error and update log

During the update a file called "update.txt" is written onto the SD card, which includes a record of the update progress and any errors having occurred in the process.

Open these files with your editor of choice (e.g. Notepad), to read the relevant content.

The file is not deleted, but supplemented. If the same SD card is always used for a device, it will provide an overview of all the firmware updates performed for the device in question.

#### Do not perform firmware downgrade

We recommend not to downgrade the firmware, as this can lead to unforeseen effects in the device.

---



Observe ESD safety precautions! See the information on page 8

#### NOTE

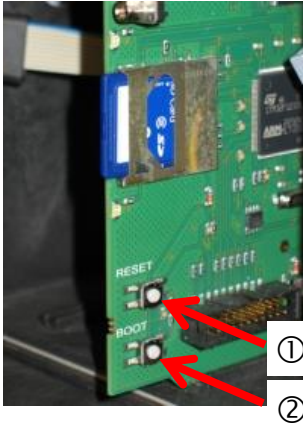

## Manual firmware update

The manual firmware update facilitates the recovery of software after failed firmware updates. The indicator and device buttons are not used in the process.

An SD card with a firmware file must be inserted in the device.

- Press and hold the "BOOT" button ① on the control card. Then briefly press the "Reset" button ②.  
The update process progresses automatically. Progress is shown by the LED lights.  
In case of several software versions on the SD card the newest version is loaded.
- Release the "BOOT" button when the update starts.

For information on handling errors see [Firmware update error messages](#).

## Maintenance

As a reminder for maintenance, an interval in days can be set. Once the interval has elapsed, the message "maintenance exceeded" is issued.

### Configuring the maintenance interval

- Select the menu  
=> Basic program => Service Time => Interval  
200d
- Change the value with the cursor keys
- Confirm the input with "OK".

### Acknowledge the maintenance

When maintenance has been performed, you must acknowledge it. This allows the reverse-running day counter to be reset to the configured value, whereupon the maintenance interval restarts afresh. The counter indicates how much time remains until the next maintenance.

- Select the menu => Basic program => Service Time  
=> Acknowledge (OK) 200d
- Confirm the input with "OK"  
The counter is reset to the value set during the maintenance interval.

|                  |      |
|------------------|------|
| SERVICE TIME     |      |
| Interval         | 200d |
| Acknowledge (OK) |      |

# Information menu

The information menu gives you scope to query current settings and states of the device.

## Call (1)

The button  allows you to call up the information menu.

Scope for queries: Operating values and program values, such as software version, container size and indicator type

### Call (1)

Remote access in the information menu to check or query the settings and operating values.

### Next measurement (2)

Display showing the time remaining before the next measurement.

### Software version (3)

Display showing the installed software version

### Bootloader version (4)

Display showing the installed bootloader version. The bootloader is needed to execute the firmware update.

### Serial number (5)

Display showing the serial number of the device.

### Operating time (6)

Display showing the operating time of the device. Can be reset in the service menu.

### Maintenance (7)

Display showing the time before the next maintenance. Once the maintenance is acknowledged, the counter is reset.

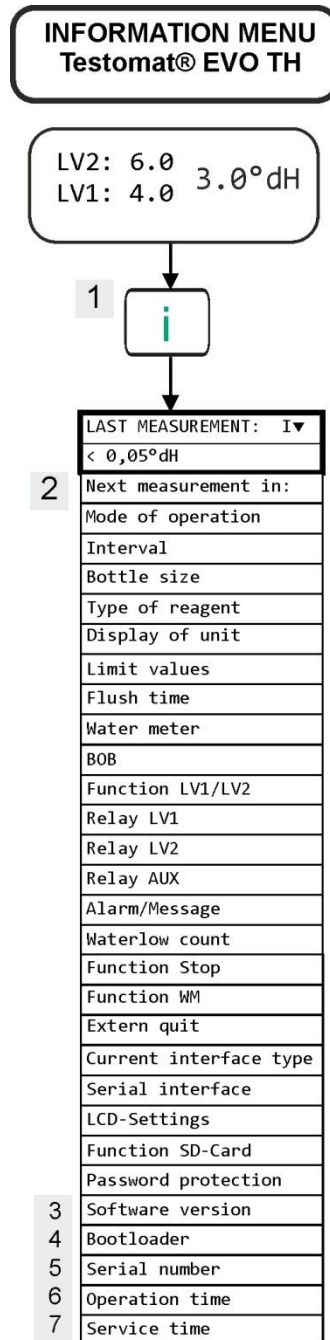

Further notes on programming and setting individual menu options can be found in [Basic programming data](#).

# Service menu

## Service (2)

### Indicator fill level (3)

Input the new fill level for **each** refill or when changing the bottle of the indicator. Just as with the menu option for input of the fill level "Reagent filling Level (0 - 100 percent)", which can be selected with "OK", the value is preset to 100 percent. If you have connected a full bottle, confirm this value with "OK". If the filling of the bottle deviates from this figure, enter the corresponding value.

### Manual operation (4)

Once you have confirmed the message box (4) with "OK", you can select the desired function with the arrow keys and execute it with "OK". These functions facilitate functional testing and commissioning.

### Internal purging (5)

Start the purging of the sampling line through the internal valves with "OK". Another press on the "OK" button ends this function.

### Purge measuring chamber (6)

The measuring chamber is purged with "OK". Pressing again stops the purging and the measuring chamber is emptied.

### Fill measuring chamber (7)

With "OK", the measuring chamber is filled once, which allows the optical water detection function to be checked.

### Empty measuring chamber (8)

With "OK", open the outlet valve to discharge the water from the measuring chamber. Another press on the "OK" button closes the outlet valve.

### Time and date (11)

To set the time, date and summertime adjustment.

## Call: (1)

The button **M** allows you to call up the program menu. Use the cursor keys to select the menu option "Service".

Settings: Reset the indicator fill level, use manual operation, language setting, diagnosis, time, operating hour counter, view/reset error history

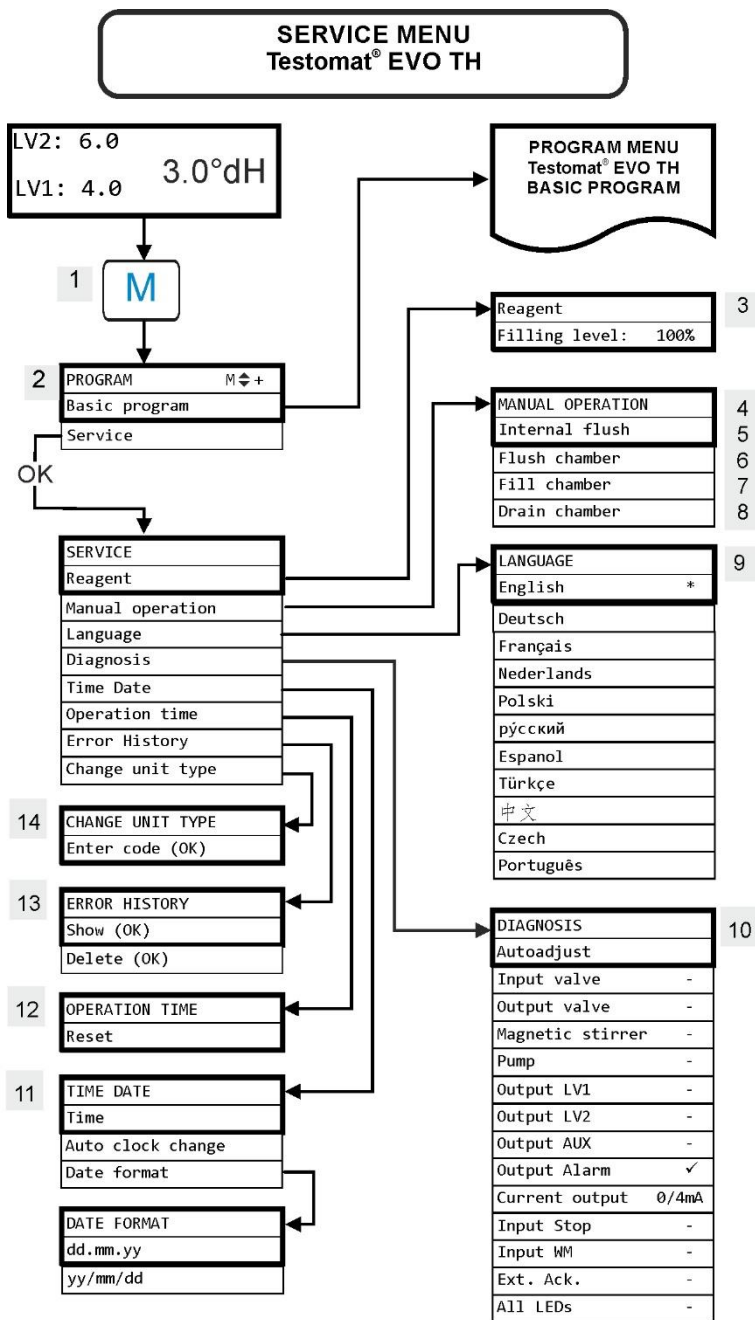

**NOTE**

## Availability of functions

All manual functions can be selected only in an analysis pause. During manual operation, no analyses are performed. All signal inputs and outputs are locked.

|            |   |
|------------|---|
| LANGUAGE   |   |
| English    | * |
| Deutsch    |   |
| Français   |   |
| Nederlands |   |
| Polski     |   |
| русский    |   |
| Español    |   |
| Türkçe     |   |
| 中文         |   |
| Czech      |   |
| Português  |   |

|                |  |
|----------------|--|
| CURRENT OUTPUT |  |
| 0/4mA          |  |
| 5mA            |  |
| 7.5mA          |  |
| 10mA           |  |
| 12.5mA         |  |
| 15mA           |  |
| 17.5mA         |  |
| 20mA           |  |

**Revert to factory default basic setting**

To retrieve the factory default basic programming, the device should be switched on while pressing and holding the buttons **OK** and **Manual**.

**CAUTION!** The most recent programming will be lost! Data on the SD card will be deleted!

**Language (9)**

Select the desired language for the display. The number of installed languages may vary.

**Diagnosis (10)**

The diagnosis menu allows you to perform an automatic comparison for the amplifier of the receiver diode and the LEDs. You can also switch and reset EV, AV and all outputs as well as test the current loop.

The "Current output" point allows the current loop to be tested. You can choose between different current values (0/4, 5, 7.5, 10, 12.5, 15, 17.5, 20mA).

**Operating time (12)**

After replacing a dosing pump or mounting the measuring chamber, you can reset the current operating time with Reset to 0 hours.

**Error history (13)**

Faults are recorded in the error history and stored if the incident is programmed as an alarm or message. If for example the lack of an indicator is not programmed to trigger an alarm/message, this is also not registered in the error history. Up to 20 error messages are recorded. The information stored in each case includes the point in time (day, month, year and time) and the type of error.

**Changing device type (14)**

Under certain circumstances, this special function can be used to programme the firmware of another device type into this device. Please contact our support team for more information.

**Basic programming**

This menu option is reached after confirming the "M" button (Menu). Here you can implement the basic programming of the device and call up various functions for service purposes.

In basic programming, the following abbreviations are used in the corresponding menu options:

s = seconds; m = minutes; h = hours; T = days; l = liters



# Structure of basic programming

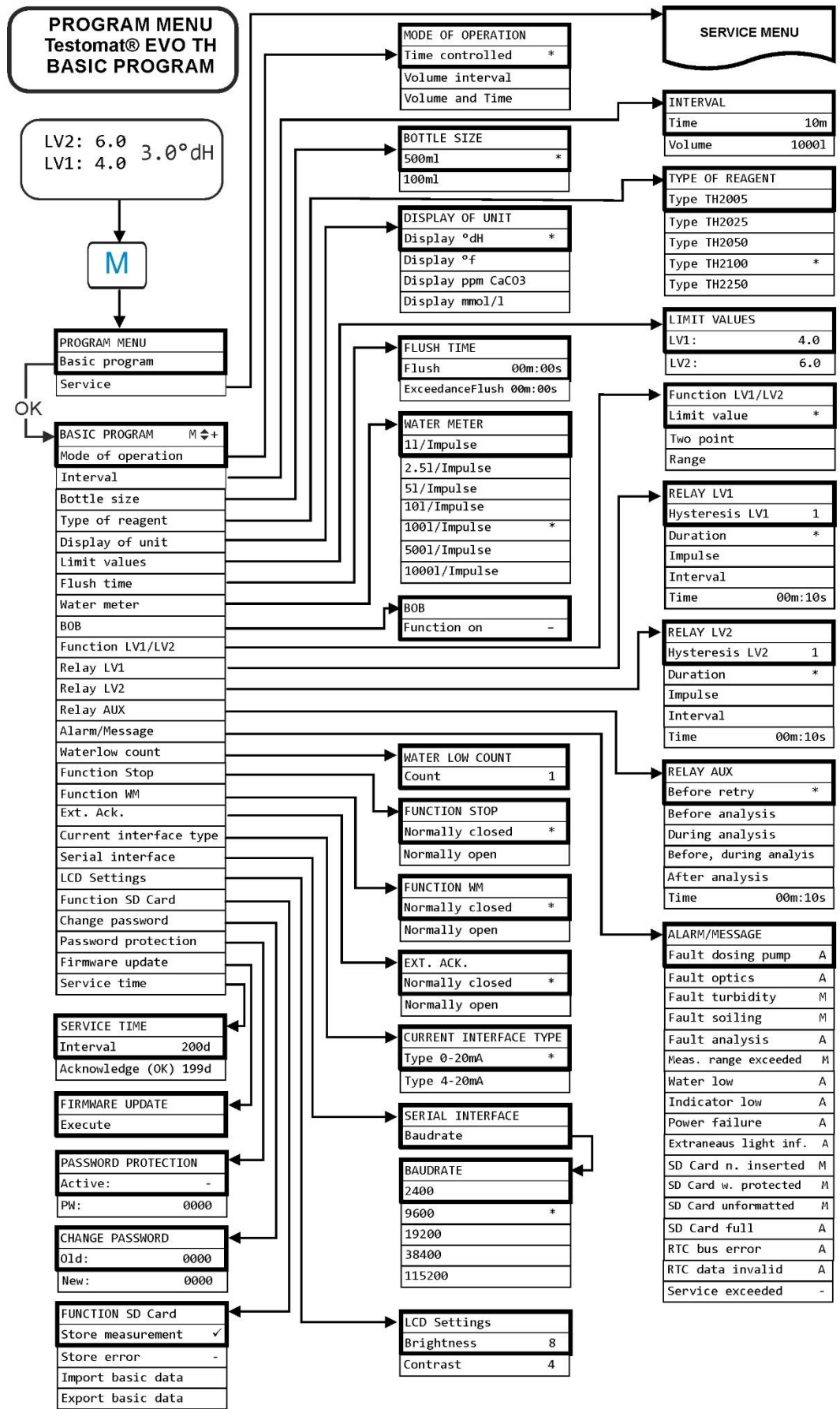

## Error messages/troubleshooting

Errors will be recorded in the error history as far as capacity allows (after which the oldest message will be deleted).

In addition, [error messages can be stored on the SD card](#), if in the menu

```
=> Basic program => Function SD-Card => Store error
```

has been activated.

Details of errors are always sent via the serial RS32 interface.

Errors are handled differently depending on type:

All errors, for which user access is required to recover the function of the device, are shown as alerts. In addition, an alarm may be triggered. However, it is not possible to completely disable the message, since the selection "-" is locked in the menu.

**In the event of such error occurring, the device reverts to pause mode.** When these errors are acknowledged with the horn button, they are deleted and the pause mode can be ended. In the event of any recurrence, the set action (message or alarm) is again triggered.

For such errors, the time of occurrence is recorded in a log.

All errors that occur only intermittently, which means they impact only on the analysis process, are cyclically checked by the device and automatically deleted when no longer present.

If these error messages are acknowledged, only the alarm is deactivated. The error message is not, however, deleted. It is deleted only when the error no longer occurs after rechecking (namely, during the following analysis, either automatically or when manually started).

These errors can also be ignored when in the menu [Alarm/message](#) "-" is selected.

In the Error history the start and end time are logged. Likewise, two notification messages are written via the serial interface and onto the SD card with the start and end times of the error (see [Message format](#)).

**Regardless of the case, the analyses are continued.**

| <b>Error number/error message</b> | <b>Description, possible causes</b>   | <b>Solution, troubleshooting measures</b>   |
|-----------------------------------|---|---|
| 01 Power failure                  | <ul style="list-style-type: none"> <li>➤ Prior power failure (also when switching off)</li> </ul>   | <ul style="list-style-type: none"> <li>➤ Check power supply</li> </ul>  |
| 02 Power failure 24V <sup>1</sup> | <ul style="list-style-type: none"> <li>➤ Failure of the internal 24V power supply</li> </ul>  | <ul style="list-style-type: none"> <li>➤ Replace 24V fuse</li> <li>➤ For all other defects, the device must be repaired</li> </ul>                                  |
| 03 RTC bus error                  | <ul style="list-style-type: none"> <li>➤ Connection to clock broken</li> </ul>  | <ul style="list-style-type: none"> <li>➤ Device should be repaired, so that the clock works. If the time is not relevant, you can keep using the device.</li> </ul> |
| 04 RTC data invalid               | <ul style="list-style-type: none"> <li>➤ Device was switched off and backup battery for clock is empty</li> </ul>                                       | <ul style="list-style-type: none"> <li>➤ Lithium battery is used up. <a href="#">Replace battery.</a></li> </ul>  |
| 05 SD Card n. inserted            | <ul style="list-style-type: none"> <li>➤ The function to store measurement values and/or error was activated, but no SD card was inserted</li> </ul>    | <ul style="list-style-type: none"> <li>➤ Insert SD card</li> </ul>  |
| 06 SD Card w. protected           | <ul style="list-style-type: none"> <li>➤ Card is write-protected</li> </ul>   | <ul style="list-style-type: none"> <li>➤ The write-protect tab at the side of the SD card must not be set to "LOCK"</li> </ul>                                      |
| 07 SD Card unformatted            | <ul style="list-style-type: none"> <li>➤ Card not formatted or formatted with an invalid file system</li> </ul>   | <ul style="list-style-type: none"> <li>➤ Format the SD card with a FAT or FAT32 file system</li> </ul>  |
| 08 SD Card failure                | <ul style="list-style-type: none"> <li>➤ Error when accessing SD card, because the file is write-protected or the card is full or defective.</li> </ul> | <ul style="list-style-type: none"> <li>➤ Remove the write protection of the file</li> <li>➤ Wipe the card</li> <li>➤ Insert new card</li> </ul>                     |
| 12 Meas. range exceeded           | <ul style="list-style-type: none"> <li>➤ The measurement scope is exceeded</li> </ul>   | <ul style="list-style-type: none"> <li>➤ Select other indicator type (basic program)</li> </ul>   |
| 13 Service exceeded               | <ul style="list-style-type: none"> <li>➤ The maintenance interval was exceeded</li> </ul>   | <ul style="list-style-type: none"> <li>➤ Perform maintenance</li> </ul>   |
| 30 Fault dosing pump <sup>1</sup> | <ul style="list-style-type: none"> <li>➤ Dosing pump is defective</li> <li>➤ No dosing message from dosing pump</li> </ul>                              | <ul style="list-style-type: none"> <li>➤ Check the cable to the dosing pump to ensure a correct connection</li> <li>➤ Replace dosing pump</li> </ul>                |
| 33 Fault optics <sup>1</sup>      | <ul style="list-style-type: none"> <li>➤ Error in the optical unit (light source or receiver defective)</li> </ul>                                      | <ul style="list-style-type: none"> <li>➤ Swap measuring chamber mounting</li> </ul>   |
| 34 Fault turbidity                | <ul style="list-style-type: none"> <li>➤ The water is too cloudy / soiled</li> </ul>  | <ul style="list-style-type: none"> <li>➤ Install an upstream water filter</li> </ul>  |
| 35 Fault soiling                  | <ul style="list-style-type: none"> <li>➤ Sight glasses are soiled</li> </ul>  | <ul style="list-style-type: none"> <li>➤ Clean sight glasses</li> </ul>   |

| Error message                  | Description, possible causes  | Solution, troubleshooting measures   |
|--------------------------------|---|--|
| 36 Fault analysis <sup>1</sup> | <ul style="list-style-type: none"> <li>➤ No correct analysis, e.g.:<br/>Air in dosing hoses?</li> <li>➤ Insufficient mixing</li> <li>➤ Indicator expiry date exceeded</li> <li>➤ Foreign indicator in the device</li> </ul> | <ul style="list-style-type: none"> <li>➤ Re-tighten dosing pump connections<br/>Renew intake insert in bottle</li> <li>➤ Check suction and pressure hose for damage</li> <li>➤ Replace stirring bar</li> <li>➤ Replace indicator, only use Heyl Testomat 2000® indicator</li> </ul>  |
| 37 Indicator low               | <ul style="list-style-type: none"> <li>➤ Indicator minimum quantity is not attained<br/>- without BOB: 10%<br/>- with BOB: according to calculation</li> </ul>  | <ul style="list-style-type: none"> <li>➤ Check indicator fill level, <a href="#">Insert new indicator bottle</a> and <a href="#">Reset indicator fill level</a>.</li> </ul>  |
| 38 Water low <sup>1 2</sup>    | <ul style="list-style-type: none"> <li>➤ No water intake despite permanent lamp "IN"</li> <li>➤ Intake pressure too low</li> <li>➤ Water remains in the measuring chamber, despite the lamp "OUT" lighting up</li> </ul>    | <ul style="list-style-type: none"> <li>➤ Check water inflow</li> <li>➤ Plug at the inlet valve corroded. Replace valve block</li> <li>➤ Clean filter sieve</li> <li>➤ Remove the pressure regulator core</li> <li>➤ Outlet valve blocked or defective. Clean or replace valve</li> </ul>   |
| 39 Ext. light influence        | <ul style="list-style-type: none"> <li>➤ Photo sensor not darkened</li> <li>➤ Permanently illuminated LED in measuring chamber</li> </ul>   | <ul style="list-style-type: none"> <li>➤ Shut the device door</li> <li>➤ Avoid sunlight</li> <li>➤ Hardware problem. Send device for repair.</li> </ul>  |
| 40 BOB not possible            | <ul style="list-style-type: none"> <li>➤ The quantity of indicator no longer suffices for 72 hours operation without supervision</li> </ul>   | <ul style="list-style-type: none"> <li>➤ Insert <a href="#">new indicator</a></li> </ul>   |
| 66 Fault auto remove air       | <ul style="list-style-type: none"> <li>➤ Automatic venting has failed.</li> </ul>   | <ul style="list-style-type: none"> <li>➤ Possible causes can be problems with the dosing pump, optics, cloudiness, dirt contamination, analysis error or water shortage. To determine the error more accurately, keep the <b>OK</b> button pressed and restart the device. Another error message is displayed. Proceed to troubleshooting, as described in the error message.</li> </ul> |

<sup>1</sup> Device reverts to pause mode until the error is acknowledged and the pause mode is exited.

<sup>2</sup> The error [Water shortage](#) is treated as a special case here, as this is the only case in which the number of consecutively occurring errors in the menu =>Basic program => Water low count can be adjusted until the relevant alarm or message is triggered. One error is generated per measurement cycle.

## Further possible errors

| Error pattern   | Possible causes  | Solution, troubleshooting measures  |
|---|--|---|
| Current loop does not function properly   | <ul style="list-style-type: none"> <li>➤ Incorrect measurement value at the output or no current measurable</li> </ul>   | <ul style="list-style-type: none"> <li>➤ Load too large</li> </ul>  |
| The device does not function immediately after being switched on. No display indication. LEDs on control card flash                                 | <ul style="list-style-type: none"> <li>➤ Hardware error or error after firmware update, depending on the LED code shown. See following section "<a href="#">Error messages after self-test</a>"</li> </ul> | <ul style="list-style-type: none"> <li>➤ If an SD card has been inserted, these notifications are stored in text form in the error log – even when the error recording function is not active.</li> </ul> |
| The device does not function immediately after being switched on. No display indication. Red and yellow LEDs next to the SD card flash alternately. | <ul style="list-style-type: none"> <li>➤ Firmware update starts, but no SD card has been inserted</li> </ul>   | <ul style="list-style-type: none"> <li>➤ Insert the SD card with the firmware file and switch on the device.</li> </ul>   |
| The device does not function immediately after being switched on. No display indication. Two red LEDs on the control card flash quickly             | <ul style="list-style-type: none"> <li>➤ Firmware update starts, but no firmware file was found on the inserted SD card</li> </ul>   | <ul style="list-style-type: none"> <li>➤ Download the firmware file from the Heyl website and copy the file onto the SD card.</li> </ul>  |
| Device does not function, even though it is switched on. No display indication. All three green LEDs on motherboard light up*                       | <ul style="list-style-type: none"> <li>➤ Ribbon cable detached from display board or motherboard</li> <li>➤ Error on display- or motherboard</li> </ul>  | <ul style="list-style-type: none"> <li>➤ Plug ribbon cable back in</li> <li>➤ Replace display- or motherboard</li> </ul>  |
| Device does not function, although it is switched on. No display indication. Fewer than three green LEDs on the motherboard light up*               | <ul style="list-style-type: none"> <li>➤ No power supply</li> <li>➤ Fuses on the power supply board defective</li> </ul>   | <ul style="list-style-type: none"> <li>➤ There is no power supply.</li> <li>➤ See <a href="#">Replacing fuses</a></li> </ul>  |

\* For position of the LEDs, see illustration on page 69

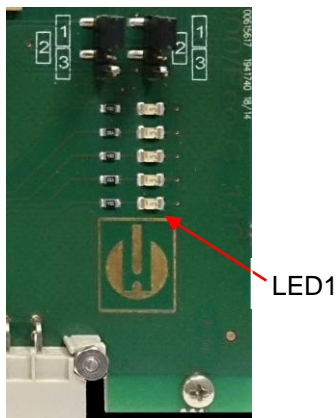

Control card

## Error messages after self-test

When switched on, the Testomat® EVO TH performs a self-test automatically and then monitors its own state continuously. If the LEDs on the **control card** flash quickly after switching on, one of the above errors has occurred and can be identified by the LED signal. In addition, the error message [is placed on the SD card in the error log](#), even when the "[Store error](#)" function is inactive.

| LED1 | LED2 | LED3 | LED4 | LED5 | Error number/text in alarm log on SD card | Solution, troubleshooting measures   |
|------|------|------|------|------|---|--|
| ☼    | ○    | ○    | ○    | ○    | 500 CTRL-FRAM IC2                         | 1. Defective component. Repair/exchange required.  |
|      | ☼    |      |      |      | 501 MB-IC12                               | See 1.   |
| ☼    | ☼    | ○    | ○    | ○    | 502 HMI-IC1                               | See 1.   |
| ○    | ○    | ☼    | ○    | ○    | 503 HMI-IC2                               | 2. Loose cable between motherboard and display?<br>If not: Defective, repair required.   |
| ☼    |      | ☼    | ○    | ○    | 504 HMI-IC5                               | See 2.   |
| ○    | ☼    | ☼    | ○    | ○    | 505 MB-IC2                                | See 1.   |
| ☼    | ☼    | ☼    | ○    | ○    | 506 MB-IC5                                | See 1.   |
| ○    | ○    | ○    | ☼    |      | 507 MB-IC3                                | See 1.   |
| ☼    | ○    | ○    | ☼    |      | 508 MB-IC4                                | See 1.   |
| ○    | ☼    | ○    | ☼    |      | 509 MB-IC6                                | See 1.   |
| ☼    | ☼    | ○    | ☼    |      | 510 Font file                             | 3. Character set or menu language could not be read.<br>Internal SD card inserted and locked?<br>If yes, perform firmware update again. If the error persists, a repair is required. |
| ○    | ○    | ☼    | ☼    |      | 511 Font info                             | See 3.   |
| ☼    | ○    | ☼    | ☼    |      | 512 Font char                             | See 3.   |
| ○    | ☼    | ☼    | ☼    |      | 513 Language file                         | See 3.   |
| ☼    | ☼    | ☼    | ☼    | ☼    | 514 Language header                       | See 3.   |
|      |      |      |      | ☼    | 515 Language info                         | See 3.   |
| ☼    |      |      |      | ☼    | 516 Menu entry not found                  | See 3.   |
|      | ☼    |      |      | ☼    | 517 Language magic                        | See 3.   |
| ☼    | ☼    |      |      | ☼    | 518 Fifo overflow                         | Software error. Firmware update required.  |
|      |      | ☼    |      | ☼    | 519 DAC Calibration invalid               | Calibration of the DAC of the 20mA current loop is invalid. Device must be recalibrated in the factory.  |
| ☼    |      | ☼    |      | ☼    | 520 Wrong firmware                        | Wrong firmware for this device, install correct firmware   |

☼ : Rapidly flashing LED (around 10 Hz). LED1 is below or next to the plug connector to the motherboard.

## Firmware update error list

### NOTE

#### Has any firmware update error or error occurred after the self-test?

This error can be distinguished using the red LED next to the SD card (see figure on page 51 **Fehler! Textmarke nicht definiert.Fehler! Textmarke nicht definiert.**):

If the LED lights up, the bootloader is active and the error concerned occurred during the firmware update.

If the LED is inactive, it is an error after the self-test.

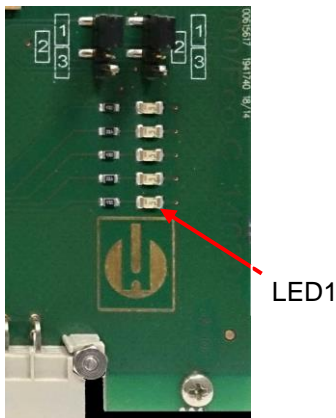

Control card

- The error category is based on the number of simultaneously flashing LEDs on the control card (for the precise error description, please refer to the following table):
- **All five LEDs flash quickly:** SD card cannot be read. Replace card. If the attempted replacement fails, there is a defect on the control card. Contact customer support; the device must be repaired.
- **Three or four LEDs flash quickly:** Defect on the control card. Contact customer support; the device must be repaired.
- **Two LEDs flash quickly:** The file for the firmware update was found, but is invalid or defective. Re-download the file.
- **One LED flashes quickly:** Problem with SD card (Write protection, formatting).
- For the Testomat® EVO TH, the filename should correspond to the following format: "100M001S00.UPD", where 001 is the version number, which increases incrementally as new versions are released.
- **LED bars not extended:** They revert to the original configuration after some time has elapsed and start from scratch: This means that during the programming, an error was detected and an attempt was made to resolve the error by repeating the update process. The entire programming process is repeated up to five times. For each repeat, the entire programming process is relaunched from the start, whereupon the LED bars "emerge".  
If, after five attempts, it is still impossible to perform any successful update, the LEDs show an error corresponding to the list on the following page. The device or the control card requires repair.  
Please also send – particularly in this case – the content of the log file on the SD card "update.txt" with the item or enclose the SD card with the device.
- Under normal cases, a firmware update is completed within 70 seconds.

| LED1 | LED2 | LED3 | LED4 | LED5 | Error number/text<br>in update.txt<br>On SD card | Solution, troubleshooting measures  |
|------|------|------|------|------|--|---|
| ☼    | ○    | ○    | ○    | ○    | 900 No SD-Card inserted                          | Insert SD card, restart firmware update   |
| ○    | ☼    | ○    | ○    | ○    | 901 SD-Card write protect                        | Confirm write-protect tab on the side of the card, restart firmware update  |
|      |      | ☼    | ○    | ○    | 902 SD-Card init. failed                         | Re-insert SD card, restart firmware update.<br>In the event of multiple failures, a defect is present and repair is required. |
| ○    | ○    |      | ☼    | ○    | 903 SD-Card unformatted                          | Format SD card, restart firmware update   |
| ☼    | ☼    | ☼    | ☼    | ☼    | 904 SD-Card read error                           | Inserted SD card defective. Initially replace card.<br>If the defect persists, even after the replacement: Repair             |
| ☼    | ☼    | ☼    |      | ☼    | 905 PCB SD read error                            | Internal micro SD card defective: Repair  |
|      | ☼    | ☼    | ☼    | ☼    | 906 PCB SD write error                           | Internal micro SD card defective: Repair  |
| ☼    | ○    | ☼    | ☼    | ☼    | 907 PCB SD init failed                           | Internal micro SD card defective: Repair  |
| ☼    | ☼    | ○    | ☼    | ☼    | 908 FRAM read error                              | Read error in internal I <sup>2</sup> C FRAM: Repair  |
| ☼    | ☼    | ☼    | ☼    |      | 909 FRAM write error                             | Write error in internal I <sup>2</sup> C FRAM: Repair   |
|      |      | ☼    | ☼    | ☼    | 910 Flash control busy                           | Initialization error STM32 Flash: Repair  |
| ○    | ○☼   | ☼    | ☼    |      | 911 Flash program error                          | Programming error STM32 Flash: Repair   |
| ☼    | ☼    | ☼    |      |      | 912 Flash write protect                          | Write protection STM32 Flash: Repair  |
| ☼    | ☼    |      |      | ☼    | 913 Flash timeout                                | Timeout STM32 Flash: Repair   |
| ☼    | ☼    |      |      |      | 914 UPD file invalid                             | Invalid update file. Re-download  |
|      | ☼    | ☼    |      |      | 915 UPD sec invalid type                         | Section in update file defective: Re-download   |

☼ : Rapidly flashing LED (around 10 Hz). LED1 is below or next to the plug connector to the motherboard.



| LED1 | LED2 | LED3 | LED4 | LED5 | Error number/text in update.txt on SD card | Solution, troubleshooting measures   |
|------|------|------|------|------|--|--|
|      |      | ☼    | ☼    |      | 916 UPD sec invalid start                  | Start info in update file defective: Re-download   |
|      |      |      | ☼    | ☼    | 917 UPD sect invalid len                   | Length info in update file defective: Re-download  |
| ☼    |      | ☼    |      |      | 918 UPD CRC error                          | Checksum error in update file: Re-download   |
| ☼    |      |      | ☼    |      | 919 UPD wrong version                      | Incorrect version of the update file: Download the correct file for the appropriate device |
|      |      |      |      | ☼    | 920 File not found                         | Update file on SD card not found: Re-copy  |
|      | ☼    |      | ☼    |      | 921 App invalid                            | Application invalid  |
|      |      | ☼    |      | ☼    | 922 App address invalid                    | Application start address invalid  |
| ☼    |      |      |      | ☼    | 924 No language file                       | Language file missing: Reprogram with new update file                                      |
|      | ☼    |      |      | ☼    | 925 Language magic wrong                   | Language file missing: Reprogram with new update file                                      |
| ☼    |      |      | ☼    | ☼    | 926 Error mem alloc                        | Storage error: Repair  |
|      | ☼    |      | ☼    | ☼    | 927 Assertion failed                       | Software error: Repair   |
| ☼    |      | ☼    |      | ☼    | 928 Unknown error                          | Unknown error: Contact support department, repair  |

☼ : Rapidly flashing LED (around 10 Hz). LED1 is below or next to the plug connector to the motherboard.

## Servicing and maintenance

### NOTE

#### Required maintenance measures

- To ensure problem-free function of the device, regular maintenance is required!
- Before sending the device in for maintenance or repair, package the power pack individually in the original box in which it was delivered. If the original packaging is no longer available, package the device to prevent breakage.

Ensure **at least** the following specified maintenance work is performed regularly, if

- The device shows the following error messages:  
" 35 Fault soiling" or " 37 Indicator low"
- The most recent maintenance was a maximum of six months earlier

#### Description of the maintenance work

A detailed description of the maintenance work can be found in the service manual. The measures described here only constitute an overview. For all additional maintenance instructions, please refer to the Testomat® EVO TH maintenance manual.



### CAUTION

#### Cleaning measures

- Never use organic solvents to clean the measuring chamber and other plastic parts!
- Observe the safety instructions when handling cleaning agents!
- If the measurement scope of the device is exceeded for an extended period, this may result in the formation of a colored film on the viewing window. This firmly adhering film can be easily removed using isopropanol.

#### Replacing indicator

Replace the indicator as follows:

- Open the lower housing door by pulling on the right side
- Unscrew the closing cap of the indicator bottle and remove the empty indicator bottle. Continue with the [Insertion of the indicator bottle](#), as described in the commissioning section and the subsequent [Resetting of the indicator fill level](#).

|               |      |
|---------------|------|
| REAGENT       |      |
| Filling level | 100% |

## Setting indicator fill level

The indicator fill level must be set when refilling the indicator bottle set or reset during a replacement.

- Select the menu  
=> Service => Reagent => Filling level  
100%
- With "OK", the current fill level is reset to 100 percent.
- If only the fill level should be reset, confirm the fill level with "OK" or
- change the value of the fill level with the cursor keys and subsequently confirm with "OK".

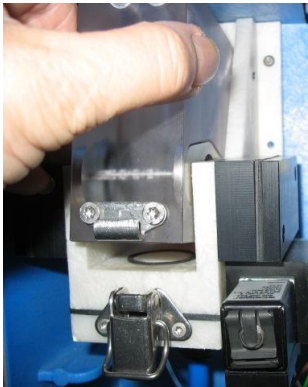

①

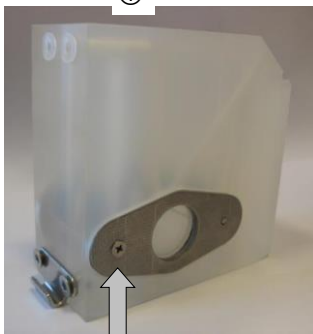

②

## Cleaning measuring chamber and sight glasses

*Cleaning interval: ¼ yearly*

- Switch off the device or press the "Pause" button
- Check that the measuring chamber is completely emptied.
- Connect the manual valve of the secondary line to the Testomat® EVO TH.
- Release the spring lock ①, tilt the measuring chamber upwards and take it out.
- Remove both the sight glass holders ② and then remove the sight glasses for cleaning.
- Remove the film on the sight glasses with isopropanol.
- Clean the measuring chamber with 10 percent hydrochloric acid and then rinse it thoroughly.
- Reinsert the sight glasses after cleaning and fix them in place with the sight glass holders
- Do not forget to insert the O-ring seals and be careful to ensure correct fitting in the groove.
- Put the measuring chamber back in place by tilting the unit and secure it with the spring lock.

**! ATTENTION**

## Removal and installation of the sight glass windows

Ensure tension-free mounting of the sight glass windows. Tighten the screws equally alternating both sides. Otherwise, the sight glass windows may break.



## Cleaning the filter housing

*Cleaning interval: ½ yearly*

- Connect the manual valve of the secondary line to the Testomat® EVO TH.
- Press the "Pause" button and wait until the current measurement has finished.
- Release the piping system of the Testomat® EVO TH with the function *Internal flush* manually.

- Switch off the device.
- Remove the hose connections on the filter housing.
- Unscrew the supply nozzles.
- Remove and clean the seal, spring and filter.
- Remove the locking pin and pull it out of the flow regulator.
- Remove the flow governor core.
- Clean the filter housing with water or alcohol and reconstruct it.
- Ensure that you insert the filter sieve with the top facing down!
- Attach the hose connections to the filter housing.

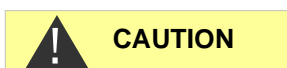

### Observe the following during maintenance measures

Water ingress at the sealing points may lead to the device components being damaged!

### Leak resistance test

Perform a leak resistance test before the first analysis:

- Switch the device to "Pause".
- Fill the measuring chamber during manual operation
- Measure out the indicator dose by hand. To do so, press the "Manual" button on the dosing pump.
- Check the connections and sealing points for leakage.

## Care instructions

The surface of the device is untreated. Avoid therefore any soiling with indicator, oil or grease. However, if the housing is soiled, clean the surface with isopropyl alcohol (never use any other kind of solvent).



Observe ESD safety precautions! See the information on page 8

## Replacing the backup battery

When the device is switched off the internal clock is powered by a lithium backup battery (CR2032 type), which is designed to have a service life of 10 years. After this period, it should be replaced for preventive reasons, and always ensuring a measured voltage <math><2.3V</math>.

The following is required when replacing the battery

- A Phillips-tip screwdriver
- A replacement battery CR 2032

Replace the battery ① as follows:

- Switch off the device and disconnect it from the power supply
- Open the upper housing door
- Remove both fixing screws ② of the upper and lower control card on the motherboard



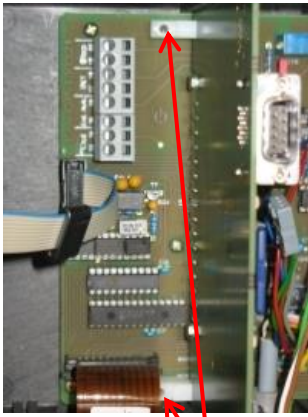

②

- Remove the control card
- Using a non-conductive tool, carefully prise the used battery out of its mounting. Avoid damaging the circuit board with the sharp edge of a screwdriver.
- Insert a new battery
- Reconstruct the circuit board by following the steps for dismantling of the same in reverse.

## Replacing fuses

### Device fuses (internal)

These fuses protect the Testomat® EVO TH device or outputs against overload and short circuit. All fuses are pluggable.

The main fuses F1 and F6 (4A MT) for outputs and equipment are located on the motherboard.

The power pack includes the four primary and secondary fuses, F2 to F5 for 24V and 12V, 3.3V

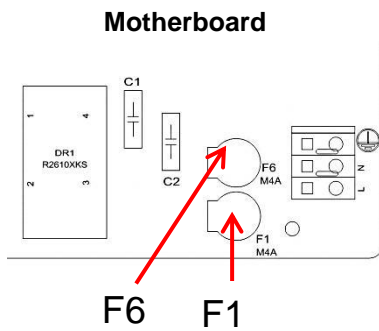

### Switched-mode power supply 100 - 240 V (built-in from device number 258464)

|           | 24 V        | 12 V/3,3 V   |
|-----------|-------------|--------------|
| Primary   | F2: 0,8 A/T | F3: 0,5 A/T  |
| Secondary | F4: 1,6 A/T | F5: 1,25 A/T |

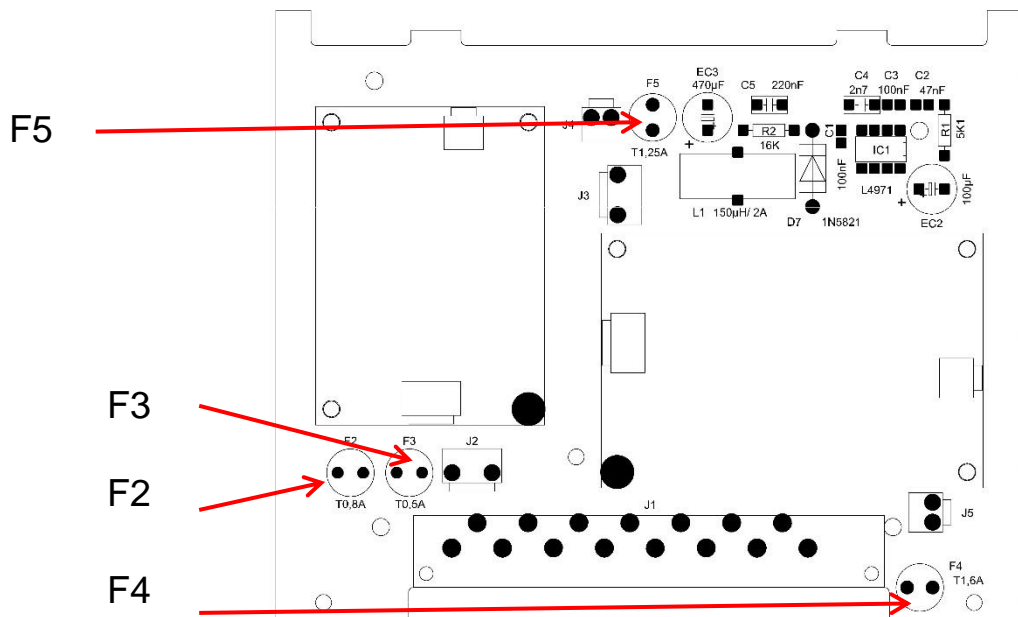

**Circuit board 24V**

Fuses F2, F3: 2A/T

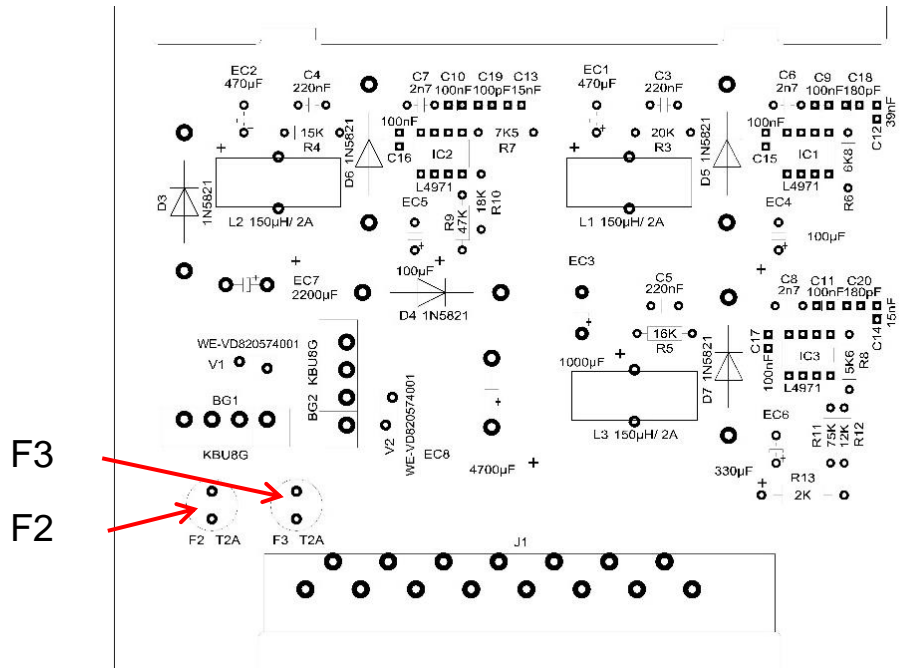

In older devices (installed up to device number 258464)

**Circuit board for power pack 230V**

|           | 24V          | 12V/3.3V     |
|-----------|--------------|--------------|
| Primary   | F2: 315 mA/T | F3: 160 mA/T |
| Secondary | F4: 2 A/T    | F5 1.6 A/T   |

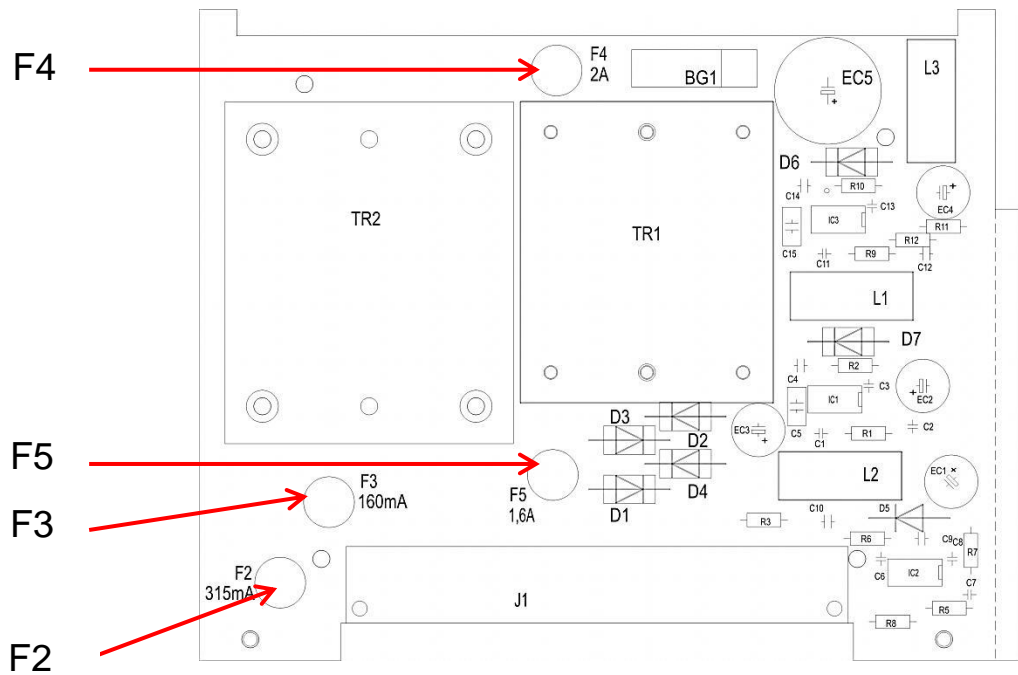

**Multi-range power supply board 100 – 240V**

|           | 24V       | 12V/3,3V    |
|-----------|-----------|-------------|
| Primary   | F2: 1 A/T | F3: 0.5 A/T |
| Secondary | F4: 2 A/T | F5: 2 A/T   |

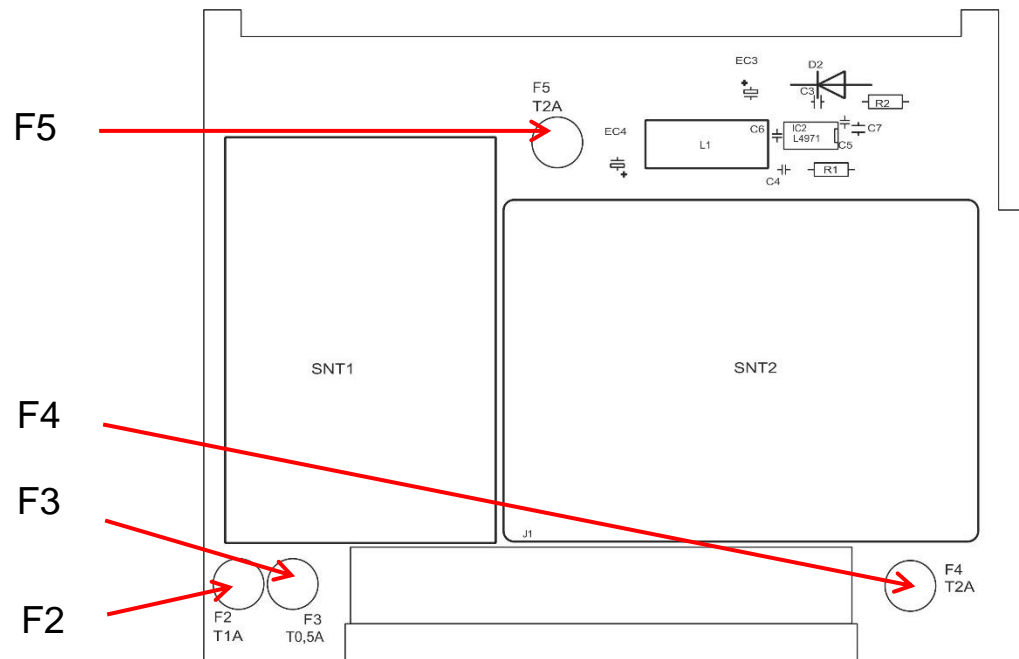



Observe ESD safety precautions! See the information on page 8

### Exchange

If not all three green LEDs on the motherboard light up, at least one fuse is defective. The supply voltage unit is next to the LED, which indicates its status.

You require:

- A Phillips-tip screwdriver
- Flat-tip screwdriver
- Replacement fuses

To find the defective fuse, proceed in accordance with the troubleshooting scheme.

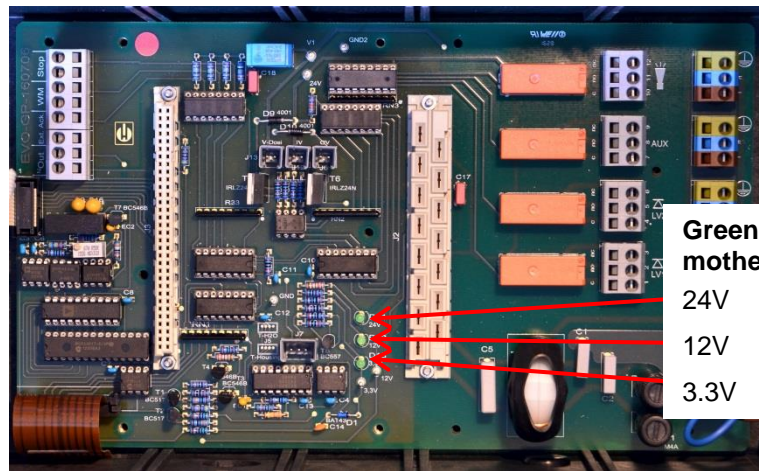

**Green LEDs on the motherboard:**  
24V  
12V  
3.3V

### Troubleshooting scheme:

| Step      | LED / lamps   | Action                          |
|-----------|---|---------------------------------|
| <b>1</b>  | Open up the device at the top and switch it on. Does at least one LED light up?   | No → Step 2<br>Yes → Steps 5, 6 |
| <b>2</b>  | Does the power supply work and is a permissible voltage measured between N and L? | No → Service<br>Yes → Step 2a   |
| <b>2a</b> | Is the voltage measured in step 2 also measured between n and l?                  | Yes → Step 4<br>No → Step 3     |



| Step | LED / lamps   | Action   |
|------|---|--|
| 3    | Primary fuse F1 od F6 on the motherboard defective. | <p><b>Disconnect device from the mains!</b></p> <p>Remove cable compartment cover (Phillips-tip screwdriver).</p> <p>Use a flat-tip screwdriver to turn and rotate the safety cover.</p> <p>Replace safety fuse 4A</p> <p>Put safety cover back in place.</p> <p>When switching on the Testomat device, check whether all three green LEDs light up. Otherwise, restart from Step 1.</p>   |
| 4    | Fuses on the power supply board defective.          | <p><b>Disconnect device from the mains!</b></p> <p>Remove both fixing screws of the upper and lower power supply board on the motherboard.</p> <p>Remove the power supply board.</p> <p>Change the plug-in fuses F2, F3, F4 and F5.</p> <p>Re-insert the power supply board.</p> <p>Assemble both fixing screws</p> <p>When switching on the Testomat device, check whether all three green LEDs light up. Otherwise, restart from Step 1.</p>   |
| 5    | 3.3V + 12 V do not light up                         | <p><b>Disconnect device from the mains!</b></p> <p>Remove both fixing screws of the upper and lower power supply board on the motherboard.</p> <p>Remove the power supply board.</p> <p>Change the plug-in fuses F5 (T1,6A) and F3 (T0,16A).</p> <p>Re-insert the power supply board.</p> <p>Assemble both fixing screws</p> <p>When switching on the Testomat device, check whether all three green LEDs light up. Otherwise, restart from Step 1.</p>  |
| 6    | 24V does not light up                               | <p><b>Disconnect device from the mains!</b></p> <p>The fuse F4 is located at the top edge of the power supply board. Change the plug-in fuse F4 (T2A).</p> <p>When switching on the Testomat device, check whether all three green LEDs now light up. Otherwise, F2 (T0,315A) must also be changed:</p> <p>Remove both fixing screws of the upper and lower power supply board on the motherboard.</p> <p>Remove the power supply board.</p> <p>Change the plug-in fuse F2 (T0,315A).</p> <p>Re-insert the power supply board.</p> <p>Assemble both fixing screws</p> <p>When switching on the Testomat device, check whether all three green LEDs light up. Otherwise, restart from Step 1.</p> |

# Checklist Testomat® EVO TH

Dear customers and service technicians,

The following checklist is no substitute for your expertise and experience applied to the process of troubleshooting. It should assist you and facilitate swifter and more systematic detection and logging of errors. No claim of completeness may be inferred from this list. We are grateful to receive supplementary feedback at any time. General operating instructions are included on the rear of this checklist.

Your device manufacturer

## Block 1 / System and device data

|             |             |               |                |                  |          |
|-------------|-------------|---------------|----------------|------------------|----------|
|             |             |               |                |                  |          |
| System type | Device type | Device number | Indicator type | Software version | Pump No. |

## Block 2 / error message and error history

Please place a cross as appropriate (X)

|  |     |    |  |                               |
|--|-----|----|--|-------------------------------|
| What does the error history of the device indicate?  |     |    |  | ( Text of the error history ) |
| Does an error message appear on the display?<br>e.g. "Water low" etc. (See instruction manual "Error messages / Help dealing with faults") | Yes | No |  | ( Text of the error message ) |

## Block 3 / Visual and functional check

Please place a cross as appropriate (X)

where applicable values / comments

|   |     |    |                  |
|---|-----|----|------------------|
| Is the mains voltage for the device in accordance with the type plate?                                    | Yes | No |                  |
| Does an indicator appear on the display?  | Yes | No |                  |
| Do the three green LEDs light up to indicate the stresses on the mother-board?                            | Yes | No |                  |
| Do LEDs flash on the control card?  | Yes | No | Which LED?       |
| Are the measuring chamber and hoses carrying water leakproof?   | Yes | No |                  |
| Is the measuring chamber clean and free of film?  | Yes | No |                  |
| Has the correct indicator type been programmed in?<br>( TH 2025 => 0.25 up to 2.5 °dH = Factory default ) | Yes | No | Type:            |
| Is the water pressure in the stipulated range (400 ml/min)?<br>(See type plate of the device)             | Yes | No | System pressure: |
| Is the outflow over the entire length laid to ensure no back pressure?<br>(No "siphon effect"!!)          | Yes | No |                  |
| Is the drain hose free?<br>(Micro-organisms due to contamination etc.)                                    | Yes | No |                  |
| Is the purge cycle / rinsing water quantity set such that<br>Fresh water can always be measured?          | Yes | No | Purge cycle:     |
| Are the hoses to the dosing pump free of air bubbles?<br>(Operate pump by hand / Perform manual analysis) | Yes | No |                  |

### PERFORM A (MANUAL) ANALYSIS

|  |     |    |                           |
|--|-----|----|---------------------------|
| Does the water level rise uniformly when filling the measuring chamber up to the overflow hole (5 mm under the top edge of the measuring chamber)?<br>(If no: check water pressure, water flow/flow regulator) | Yes | No |                           |
| Does the indicator pump dose when an analysis is triggered?<br>(LED on the pump comes on!)   | Yes | No | Number of dosing strokes: |
| After the dosing process, is the indicator correctly mixed with the water in the measuring chamber?<br>Check the stirrer! => See maintenance manual "Alignment operation"                                      | Yes | No |                           |

### PROGRAMMING DATA / OPERATING CONDITIONS

|   |     |    |               |
|---|-----|----|---------------|
| Are the configured limit values correct? (Within the measurement range/corresponding to the performance limit of the system?)   | Yes | No | Limit values: |
| Is the Testomat continually supplied with mains voltage – except during maintenance work/emergency cases?<br>(Intermediate switching off only with "PAUSE" button or "Stop"! input) | Yes | No |               |

More details of error messages and possible causes of errors can be found in the **operating instructions** under "Error messages / Help dealing with faults".

Further functional tests (e.g. overflow detection and gain adjustment => "Special function alignment operation") and service indications can be found in the **maintenance manual**.

After performing these tests, experience supports the assumption that the checked functions (Block 3) work flawlessly if the questions are answered with "Yes". We recommend carrying out these tests systematically during each inspection or any disruptions which arise.

# Device settings for Testomat® EVO TH

## Caution!

Your settings may be deleted in the event of a repair. Accordingly, export your device settings onto an SD card before sending the device for repair to our service team. The settings can be re-imported after the repair.

| Menu                          | Setting |
|-------------------------------|---------|
| <b>MODE OF OPERATION</b>      |         |
| Time controlled               |         |
| Volume interval               |         |
| Volume and time               |         |
| <b>INTERVAL</b>               |         |
| Time                          |         |
| Volume                        |         |
| <b>BOTTLE SIZE</b>            |         |
| 500ml bottle                  |         |
| 100ml bottle                  |         |
| <b>TYPE OF REAGENT</b>        |         |
| Type TH2005                   |         |
| Type TH2025                   |         |
| Type TH2050                   |         |
| Type TH2100                   |         |
| Type TH2250                   |         |
| <b>DISPLAY OF UNIT</b>        |         |
| Display °dH                   |         |
| Display °f                    |         |
| Display ppm CaCO <sub>3</sub> |         |
| Display mmol/l                |         |
| <b>LIMIT VALUES</b>           |         |
| LV1:                          |         |
| LV2:                          |         |
| <b>FLUSH TIME</b>             |         |
| Flush                         |         |
| ExceedanceFlush               |         |
| <b>WATER METER</b>            |         |
| 1 l/Impulse                   |         |
| 2,5 l/Impulse                 |         |
| 5 l/Impulse                   |         |
| 10 l/Impulse                  |         |
| 100 l/Impulse                 |         |
| 500 l/Impulse                 |         |
| 1000 l/Impulse                |         |
| Imp./L                        |         |
| <b>BOB</b>                    |         |
| Function on                   |         |
| <b>FUNCTION LV1/LV2</b>       |         |
| Limit value                   |         |
| Two point                     |         |
| Range                         |         |
| <b>RELAY LV1</b>              |         |
| Hysteresis LV1                |         |
| Duration                      |         |
| Impuls                        |         |
| Interval                      |         |
| Time:                         |         |
| <b>RELAY LV2</b>              |         |
| Hysteresis LV2                |         |

|                               |  |
|-------------------------------|--|
| Duration                      |  |
| Impuls                        |  |
| Interval                      |  |
| Time:                         |  |
| <b>RELAY AUX</b>              |  |
| Before retry                  |  |
| Before analysis               |  |
| During analysis               |  |
| Before + during analysis      |  |
| After analysis                |  |
| Time                          |  |
| <b>WATER LOW COUNT</b>        |  |
| Count                         |  |
| <b>FUNCTION STOP</b>          |  |
| Normally closed               |  |
| Normally open                 |  |
| <b>FUNCTION WM</b>            |  |
| Normally closed               |  |
| Normally open                 |  |
| <b>EXTERN ACK.</b>            |  |
| Normally closed               |  |
| Normally open                 |  |
| <b>CURRENT INTERFACE TYPE</b> |  |
| Type 0-20 mA                  |  |
| Type 4-20 mA                  |  |
| <b>SERIAL INTERFACE</b>       |  |
| Baudrate                      |  |
| <b>LCD SETTINGS</b>           |  |
| Brightness                    |  |
| Contrast                      |  |
| <b>FUNCTION SD CARD</b>       |  |
| Store measurement             |  |
| Store error                   |  |
| Import basic data             |  |
| Export basic data             |  |
| <b>SERVICE TIME</b>           |  |
| Interval                      |  |
| <b>LANGUAGE</b>               |  |
| English                       |  |
| German                        |  |
| Français                      |  |
| Nederlands                    |  |
| Polski                        |  |
| русский                       |  |
| Español                       |  |
| Türkçe                        |  |
| 中文                            |  |
| Czech                         |  |
| Português                     |  |

## Spare parts and accessories for Testomat® EVO TH

| <b>Pressure regulator</b>               |  |
|---|--|
| 40125                                   | Controller / filter mounting, complete       |
| 40120                                   | Controller / filter mounting                 |
| 40129                                   | Controller plug T2000, complete              |
| 11225                                   | Flow governor core complete                  |
| 11270                                   | Locking pin                                  |
| 11217                                   | Filter sieve for inflow 19.5dx25             |
| 11218                                   | Spring for inflow                            |
| 40121                                   | Inlet connection                             |
| 40153                                   | Male connector G 1/4" -6                     |
| 40157                                   | Angle male connector G 1/8"                  |
| <b>Measuring chamber</b>                |  |
| 40173                                   | Viewing window with seal, T2000              |
| 40170                                   | Viewing window 30x3                          |
| 40176                                   | Viewing window holder, vertical and weighted |
| 33253                                   | Screw M3x40, A2, DIN 965                     |
| 40032                                   | Tensioning hook TL-17-201-52                 |
| 11210                                   | Plug for measuring chamber                   |
| 40022                                   | Measuring chamber T2000 complete             |
| <b>Measuring chamber mounting</b>       |  |
| 40029                                   | Measuring chamber mounting complete SP       |
| 40050                                   | Stirrer                                      |
| 40156                                   | Male connector 3/8" -10, processed           |
| 40056                                   | Magnetic valve, 2/2 ways, Testomat® EVO TH   |
| <b>DosiClip® dosing pump</b>            |  |
| 270470                                  | DosiClip dosing pump                         |
| 40011                                   | Hose, suction, complete                      |
| 40016                                   | Hose, pressure, complete                     |
| 40040                                   | Valve set                                    |
| 32046                                   | Covering hood CNH 45 N                       |
| <b>Bottle connection/suction device</b> |  |
| 40131                                   | Screw cap with Insert T2000                  |
| 40130                                   | Screw cap GL32 - hole                        |
| 40135                                   | Insert for screw cap with suction pipe       |

| <b>Device spare parts</b>                                |  |
|--|--|
| 31582  | Fuse GS-M 5x20E 4A MT                        |
| 31655  | Fuse T2A (24V)                               |
| 12140  | Fuse T1.6A (12V/3.3V)                        |
| 31622  | Fuse T0.16A                                  |
| 31585  | Fuse T0.315A                                 |
| 32383  | Motherboard complete 230V                    |
| 32387  | Controller board complete                    |
| 32385  | Display circuit board EVO complete           |
| 32407  | 24 V Power supply SP                         |
| 37734  | Cable gland M16 x 1,5                        |
| 37735  | Nut for cable gland M16 x 1,5                |
| 37736  | Blanking plug for cable gland                |
| 31713  | Ribbon cable 10 pol. with ferrite            |
| 31656  | Jumper                                       |
| 40060  | Cable harness 2V for T2000                   |
| 40062  | Cable harness 2P for T2000                   |
| 37320  | Standard SD card 2 GB                        |
| 31999  | Lithium backup battery CR2032                |
| 32394  | Switched-mode power supply 100V – 240VAC, SP |
| 32187  | Drain funnel                                 |
| 32898  | Label for 24 V (motherboard)                 |
| <b>Spare parts required for 2 - 3 years of operation</b> |  |
| 40173  | Viewing window with seal, T2000              |
| 11217  | Filter sieve for inflow 19.5dx25             |
| 40124  | Seal kit T2000                               |

## Accessory

### Indicators

| Indicator type | Range                        | Quantity | Art. No.: |
|----------------|------------------------------|----------|-----------|
| TH2005         | Water hardness 0.05 - 0.5    | 500 ml   | 152005    |
| TH2005         | Water hardness 0.05 - 0.5    | 100 ml   | 151005    |
| TH2025         | Water hardness 0.25 - 2.5    | 500 ml   | 152025    |
| TH2025         | Water hardness 0.25 - 2.5    | 100 ml   | 151025    |
| TH2050         | Water hardness 0,5 – 5,0 °dH | 500 ml   | 152050    |
| TH2050         | Water hardness 0,5 – 5,0 °dH | 100 ml   | 151050    |
| TH2100         | Water hardness 1.0 - 10.0    | 500 ml   | 152100    |
| TH2100         | Water hardness 1.0 - 10.0    | 100 ml   | 151100    |
| TH2250         | Water hardness 2.5 - 25.0    | 500 ml   | 152250    |
| TH2250         | Water hardness 2.5 - 25.0    | 100 ml   | 151250    |

### Additional accessories

| Art. No. | Designation                                |
|----------|--|
| 040187   | Connector set: Cock, hoses, reducers       |
| 130010   | Mini irrigator type R for Testomat devices |
| 270352   | Service set including flow controller      |
| 270410   | MepuClip booster pump                      |
| 100490   | Standard SD card 2GByte                    |
| 040123   | Conversion kit for water intake *)         |
| 270337   | Maintenance case T2000 Heyl                |
| 100491   | WLAN SD card 8GByte                        |

#### **\*) Conversion kit for water intake, Art. No. 040123**

When using fabric pressure hoses (e.g. for existing installations), please replace the plug connection on the controller and filter housing for a plug for the quick-release coupling (not included in the delivery scope).

A current device overview of the available accessories can be found in details of our delivery scope.

## Technical Data

|                         |   |   |
|-------------------------|---|---|
| Power supply:           | 100-240 VAC / 150-350 VDC, 50/60 Hz<br>24 VAC   |   |
| Power consumption:      | max. 50 W   |   |
| Protection class:       | I   |   |
| Protection type:        | IP 44   |   |
| Conformity:             | EN 61326-1, EN 61010-1<br>BS EN IEC 61326-1, BS EN<br>61010-1+A1  |  |
| Ambient temperature:    | 10 – 40°C   |   |
| Measuring range:        | See section "Service description"   |   |
| User power supply:      | Switched power supply with 4A fuse-protected  |   |
| Durability relay:       | DC: 8A at 30V or 0.28A at 250V<br>AC: 8A at 415V  |   |
| Current loop:           | 0/4 - 20 mA<br>Maximum load 500 ohm corresponding to<br>10V voltage, voltage isolated   |   |
| SD card interface:      | For SD and SDHC cards up to max.<br>32GByte, FAT/FAT32 formatting   |   |
| WLAN:                   | Optional including WLAN SD card in the<br>accessories   |   |
| Dimensions:             | W x H x D = 380 x 480 x 280 mm  |   |
| Weight:                 | Around 9.0 kg   |   |
| Other:                  | The device is power-failure protected   |   |
| <b>Water connection</b> |   |   |
| Working pressure:       | 1 to 8 bar / $1 \times 10^5$ to $8 \times 10^5$ Pa<br><b>or</b><br>0.3* to 1 bar / $0.3 \times 10^5$ to $1 \times 10^5$ Pa<br>(after removing the valve body) |   |
| Water intake:           | Opaque pressure hose with external<br>diameter 6/4x1 mm   |   |
| Water drain:            | Hose with internal diameter 12 mm   |   |
| Water temperature:      | 10 – 40°C   |   |
| <b>Properties</b>       | pH value >4   |   |
| <b>Water sample**</b>   | CO <sub>2</sub> value < 20 mg/l   |   |

\* When using the Testomat® EVO TH with an upstream pressure of 0.3 bar, it must be ensured that a minimum flow quantity of 400 ml/min can traverse the measuring chamber.

\*\* see also notes on page 10

**We reserve the right to make structural changes with continual improvement in mind! Our user manuals are regularly updated. If you have an older version (see details of the version on the rear of the instructions), you can find the most recent version of the operating instructions on our homepage [www.heylanalysis.de](http://www.heylanalysis.de) under Download.**

## Declaration of conformity



EC Conformity Declaration



**for the following product**

**Testomat® EVO TH**

**Online analysis instrument for residual total hardness (water hardness)**

We hereby confirm that the above product conforms to the principal health and safety regulations laid down in the EC Directives 2014/30/EU and 2014/35/EU.

This declaration applies to all units produced in accordance with the attached manufacturing documents which are a constituent part of this declaration.

**The product was assessed with reference to the following standards:**



**EN 61326-1:** Electrical equipment for measurement, control and laboratory use - EMC requirements

**EN 61010-1:** Safety requirements for electrical equipment for measurement, control and laboratory use



**BS EN IEC 61326-1** Electrical equipment for measurement, control and laboratory use. EMC requirements, General requirements

**BS EN 61010-1+A1** Safety requirements for electrical equipment for measurement, control, and laboratory use. General requirements

This declaration is made on behalf of

**GEBRÜDER HEYL**  
**Analysentechnik GmbH & Co. KG**  
**Orleansstraße 75b**  
**31135 Hildesheim**

by

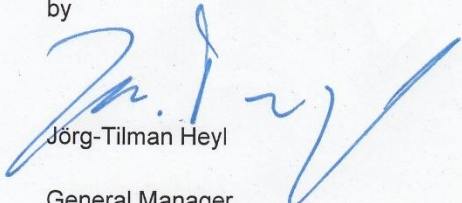
  
Jörg-Tilman Heyl  
General Manager

Hildesheim, 12/08/2021

NRTL certificate

CERTIFICATE ◆ CERTIFICADO ◆ CERTIFIKAT ◆ 認證書 ◆ CERTIFICATE ◆ ZERTIFIKAT



# CERTIFICATE

No. U8 094434 0013 Rev. 00

**Holder of Certificate:** **Gebrüder Heyl Analysentechnik GmbH & Co. KG**  
 Orleansstr. 75b  
 31135 Hildesheim  
 GERMANY

**Certification Mark:**



**Product:** **Measuring appliances**

**Model(s):** **Testomat EVO TH**

**Parameters:**

|                  |            |
|------------------|------------|
| Rated Voltage:   | 100-240VAC |
| Rated Frequency: | 50/60 Hz   |
| Max Current:     | 4A         |
| Protection Class | I          |

**Tested according to:** UL 61010-1:2012/R:2019-07  
 CAN/CSA-C22.2 No. 61010-1:2012/A1:2018-11

This product was voluntarily tested to the relevant safety requirements referenced on this certificate. It can be marked with the certification mark above. The mark must not be altered in any way. This product certification system operated by TÜV SÜD America Inc. most closely resembles system 3 as defined in ISO/IEC 17067. Certification is based on the TÜV SÜD "Testing and Certification Regulations". TÜV SÜD America Inc. is an OSHA recognized NRTL and a Standards Council of Canada accredited Certification body.

**Test report no.:** 713074148

**Date,** 2021-09-13

*(Signature)*  
 ( Benedikt Pulver )



## Test-type approval certificate



# Bescheinigung

Dem Hersteller wird aufgrund eines Prüfberichts zur Bauteilprüfung folgendes Bauteilkennzeichen zuerkannt:

|  |  |
|--|--|
| Kategorie Bauteilkennzeichen:                        | Wasserüberwachungseinrichtung  |
| Technische Überwachungsorganisation und Prüfbericht: | TÜV Rheinland von 2021-11-24   |
| Hersteller:  | Gebrüder HEYL Analystechnik GmbH & Co. KG<br>Orleansstraße 75 b<br>31135 Hildesheim  |
| Bauteilkennzeichen-Nr.:                              | TÜV . WÜH . 21 - 025   |
| Bauart:  | fotometrische Messkammer mit Steuergerät   |
| Typ:   | Testomat EVO TH  |
| Die Zuerkennung erfolgt in Anwendung von:            | - VdTÜV-Merkblatt Wasserüberwachungseinrichtung 100,<br>Ausgabe 2017-03-15, in Verbindung mit VdTÜV-Merkblatt<br>Allgemeines 002, Ausgabe 2019-02-22 |
| Gültig bis:  | 2026-11-30   |

**Die Zuerkennung kann widerrufen werden. Die bisherige Bescheinigung wird hierdurch ersetzt.**

Hinweis: Der Hersteller oder Importeur ist verpflichtet, den zuständigen Sachverständigen zu beauftragen, Bauteile aus der laufenden Fertigung auf Übereinstimmung mit dem Baumuster einmal jährlich stichprobenweise zu überprüfen.

TÜV-Verband e. V.  
Friedrichstraße 136  
10117 Berlin

Tel.: +49 30 760095-400  
E-Mail: [bauteile@tuev-verband.de](mailto:bauteile@tuev-verband.de)

Ingo Blohm  
2022.01.17 13:58:32  
+01'00'

Geschäftsbereich Industrie und Anlagentechnik

[www.tuev-verband.de](http://www.tuev-verband.de)

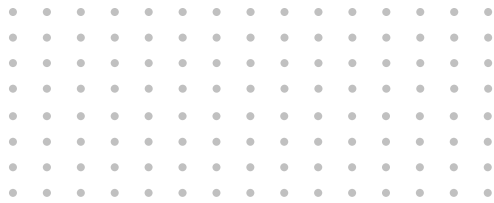

Gebrüder Heyl  
Analyse-technik GmbH & Co. KG  
Orleansstraße 75b  
D 31135 Hildesheim  
[www.heylandanalysis.de](http://www.heylandanalysis.de)

Testomat\_EVO\_TH\_EN\_240403



Scan the code and  
visit us on our homepage!