

Operating Instructions Titromat[®] M2

Titration monitor for carbonate
hardness 0.05 - 2.0°dH



Content

| | |
|---|-----------|
| Content | 2 |
| Important safety information | 4 |
| Intended use | 4 |
| Qualification of the staff | 4 |
| Warning notices in these instructions | 5 |
| Further documents | 5 |
| Pay particular attention to | 5 |
| General instructions | 5 |
| Installation | 6 |
| Operation | 6 |
| After switch-off and longer downtime..... | 6 |
| Cleaning | 6 |
| De-installation | 6 |
| Disposal | 6 |
| Scope of delivery | 7 |
| Performance specifications | 7 |
| Application instructions | 8 |
| Installation | 9 |
| Operating Titromat® M2 in the pressure range of 0.3 to 1 bar..... | 9 |
| Installing Titromat® M2 | 9 |
| Connecting the water inlet and outlet | 10 |
| Water inlet..... | 10 |
| Water outlet..... | 10 |
| Connecting the power supply and devices | 11 |
| Block diagram Titromat® M2 | 11 |
| Internal design Titromat® M2 | 12 |
| Connecting the mains voltage..... | 13 |
| Connecting the plant components | 14 |
| Connecting the inputs and outputs | 15 |
| Commissioning | 16 |
| Inserting the indicator bottle..... | 16 |
| Extracting the indicator | 16 |
| Opening the water inlet | 16 |
| Instrument settings and data input..... | 17 |
| Functions of the operating and display elements | 17 |
| Switching Titromat® M2 on/off..... | 17 |
| Display functions | 18 |
| Operating elements and function keys | 19 |
| Operating system | 20 |
| Password protection and basic program | 21 |
| Selecting the operating mode | 22 |
| Selecting the display unit | 23 |
| Entering further basic program data | 24 |
| Internal flushing..... | 24 |
| External flushing | 24 |
| Interval pause | 25 |
| Limit value monitoring | 25 |
| Hysteresis | 26 |
| Switch functions of the limit value outputs LV1 and LV2 | 27 |
| Switch function 0, duration..... | 27 |

| | |
|---|-----------|
| Switch function 1, impulse | 27 |
| Switch function 2, interval | 27 |
| Switch function 3, two-point | 27 |
| Function IN1 | 28 |
| Water meter | 28 |
| Alarm/Message | 28 |
| Function AUX | 29 |
| Service II | 29 |
| Calibration | 29 |
| Reset operating time | 31 |
| Maintenance interval | 31 |
| Water quantity RESET | 31 |
| Description of the signal inputs/outputs | 32 |
| Interfaces (optional) | 33 |
| Installing the interface cards SK910/RS910 | 33 |
| Monitoring a measuring point | 34 |
| Monitoring of two measuring points | 34 |
| Calculation of output currents | 35 |
| Serial interface RS232 | 35 |
| SD card data logger | 36 |
| Description of the relay outputs | 36 |
| Flushing (external flush valve) | 36 |
| LV1 and LV2 limit value outputs | 36 |
| Measuring points 1 or 2 (measuring point switch-over) | 37 |
| AUX (programmable function output) | 37 |
| Alarm (fault message output) | 38 |
| Maintenance (output for maintenance message) | 38 |
| Information menu "i" | 39 |
| Program menu "M" | 40 |
| Structure of the basic program | 42 |
| Error messages/Troubleshooting | 43 |
| Further information | 44 |
| Maintenance | 45 |
| Description of maintenance work | 45 |
| Service instructions | 46 |
| Titromat® M2 spare parts and accessories | 47 |
| Accessories | 48 |
| Technical data | 49 |
| Conformity Declaration | 50 |
| Check List Titromat® | 51 |
| Product overview Testomat 2000®-Instruments | 53 |



Important safety information

- Please read these operating instructions carefully and completely prior to working with the instrument.
- Ensure that these operating instructions are always available for all users.
- These operating instructions must always be passed on to the new owner should Titromat® M2 change hands.
- Always adhere to hazard warnings and safety information when using reagents, chemicals and cleaning agents. Please adhere to the respective safety data sheet! Download the safety data sheets for the supplied reagents at <http://www.heylanalysis.de>.

Intended use

Titromat® M2 is used for the automatic determination and monitoring of carbonate hardness (minus m-value) in water.

- Always adhere to the performance limits stated in the section entitled “Technical data”.
- Always observe the application areas/application limits of the indicators and the requirements of the medium being measured.

To ensure correct and intended usage, always read and understand these instructions, especially the section entitled “Important safety information”, prior to use.

The instrument is not used as intended if

- it is used in areas not specified in these instructions.
- it is used in areas which do not correspond to the ones described in these instructions.

Qualification of the staff

Assembly and commissioning require fundamental electrical and process engineering knowledge as well as knowledge of the respective technical terms. Assembly and commissioning should therefore only be carried out by a specialist or by an authorised individual supervised by a specialist.

A specialist is someone who due to his/her technical training, know-how and experience as well as knowledge of relevant regulations can assess assigned tasks, recognise potential hazards and ensure appropriate safety measures. A specialist should always adhere to the relevant technical regulations.

Warning notices in these instructions

The warning notices in these instructions warn the user about potential dangers to individuals and property resulting from incorrect handling of the instrument. The warning notices are structured as follows:

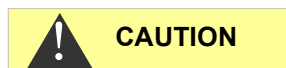

Description of the type or source of danger

Description of the consequences resulting from non-observance

- Preventive measures. Always adhere to these preventive measures.
-

“**DANGER**” indicates an immediate hazardous situation which, if not avoided, will result in death or serious injury.

“**WARNING**” indicates a potentially hazardous situation which, if not avoided, could result in death or serious injury.

“**CAUTION**” indicates a potentially hazardous situation which, if not avoided, could result in minor or moderate injuries or property damage.

“**NOTE**” indicates important information. If this information is not observed, it may result in an undesirable result or state.

Further documents

Titromat® M2 is a plant component. Therefore, always observe the maintenance manual of Testomat 2000®/Testomat ECO® and the documentation of the plant manufacturer.

Pay particular attention to

General instructions



- Adhere to health and safety regulations, electrical equipment safety regulations, and environmental protection regulations valid in the country of use and at the installation site.
- Adhere to national and local regulations during installation and commissioning.
- Always protect the instrument against moisture and humidity. It should never come into contact with condensation or splash water.
- Do not carry out any changes or modifications at the instrument which are not described in these instructions; failure to adhere to these instructions will negatively affect any warranty claims that you make thereafter.

**WARNING**

Installation

- Always completely disconnect the relevant plant part before installing the instrument or connecting/disconnecting it to/from the power supply. Secure the plant against reconnection.
- Only connect the instrument to the mains voltage specified on the rating plate.
- Always observe technical data and ambient parameters.

NOTE

- Titromat® M2 requires an interference free and stable power supply. If necessary, use a mains filter to protect Titromat® M2 against interference voltages caused, e.g., by solenoid valves or large motors. Never lay connecting cables parallel to power cables.

Operation

- Ensure that the maximum electrical load capacity of the relay outputs is never exceeded.
- Immediately switch off Titromat® M2 and contact service staff if malfunctioning occurs. The warranty will be void if you tamper with or attempt to repair Titromat® M2. Repairs must be carried out by authorised service staff.

After switch-off and longer downtime

- Ventilate the indicator leads as described in the start-up, because longer downtimes (more than 6 hours) can cause the indicator in the leads to retract.
- Do not switch off the appliance for longer periods (e.g. over the weekend) via the start/stop output. The indicator can retract from the leads. This results in measurement errors after the appliance is switched on.

Cleaning

- Only use a dry, lint-free cloth for cleaning.

De-installation

- Prior to de-installing a defective instrument, always write down a description of the error (failure effect). It is only possible to repair a defective instrument (irrespective of the warranty period) if it has been de-installed and returned to us with a description of the error.

Disposal

- Dispose of the instrument in accordance with national regulations.

Scope of delivery

1x Titromat® M2

1x plastic bag containing 2 screw caps with a hole and an insert for the screw cap of the indicator bottles

1x operating instructions

Performance specifications

Titromat® M2 is used for the automatic determination and monitoring of carbonate hardness (minus m-value) in water. The measuring range with the reagents TC2020A and TC2020B is 0.05 - 2.0°dH (0.018 - 0.72 mmol/l) with a resolution of 0.05°dH (0.02 mmol/l) and accuracy of +/-0.1°dH (+/-0.04 mmol/l).

- Simple, menu-driven operating and programming via a plain text display
- Freely selectable hardness unit in °dH, °f, ppm CaCO₃, mmol/l
- High measuring accuracy provided by a precise piston-dosing pumps
- Analysis initiation:
 - Automatic interval operation
(Interval pause justable from 0 to 99 minutes)
 - External control
 - Volume controlled (water meter)
- Two independent limit values with hysteresis (1, 2 or 3 bad analyses) and adjustable switch functions
- Monitoring of two measuring points (change-over via external solenoid valves)
- Internal error documentation
- Programmable service address
- Programmable maintenance interval for a maintenance request
- Extended operating periods due to 500 ml indicator storage bottle
- **optional**
 - Interface (0/4-20 mA or 0/2-10 V) or
 - Interface RS 232
 - SD Card Datalogger

| | Unit | | | |
|--------------------------------------|----------------------|----------------------|-----------------------|-----------------------|
| | °dH | °f | ppm CaCO ₃ | mmol/l |
| Range/Display (Resolution) | 0.05 – 2.0 (0.05) | 0.09 – 3.6 (0.09) | 0.89 – 35.7 (0.89) | 0.02 – 0.72 (0.02) |

Application instructions

- Wait at least 5 seconds before switching the instrument on and then off again at the main switch.
- In order for Titromat® M2 to operate reliably, use Heyl indicators.
- For pH values below pH 4.3 it is not possible to measure the carbonate hardness (of the m value. This is displayed as the measurement result "<0.05°dH".
- At a concentration of more than 100 mg/l of CO₂ (carbon dioxide) in the water, the excess carbon dioxide must be removed by installing an aerator in the feed water line to the Titromat® M2 unit.
- A fine preliminary filter should be installed if the medium to be measured has a strong intrinsic colouring or is turbid.
- The concentration of influencing contents can be determined by using our colorimetric TESTOVAL® test kit.
- Careful handling of the instrument increases both its operational reliability and service life! Therefore, carry out a visual inspection at regular intervals as described below:
 - Has the use-by-date of the indicator expired?
 - Are the hose connections of the dosing pump free of leaks?
 - Is there any air inside the dosing hoses?
 - Are all the water connections free of leaks?
 - Are the doors of the instrument closed properly?
 - Is the instrument heavily soiled?
 - Are the measuring chamber and the drain duct/drain hose clean?
- Trouble-free operation is only possible when maintenance is carried out on a regular basis! For more information, please refer to the section entitled "Maintenance" and the "Maintenance manual of Testomat 2000®/Testomat ECO®"
- If problems occur, please refer to the section entitled "Error messages/Troubleshooting".



CAUTION

No opening of the measuring chamber holder!

Do not open the measuring chamber holder. You cannot carry out any repairs in this area, but damage the device. If you open the measuring chamber holder, your warranty will expire.

NOTE

No dosage control!

When TC indicators are used to determine carbonate hardness, the device does not monitor the dosage. This concerns the indicators TC 2020 A / B.

Ensure that there is always sufficient indicator available for the measurement. Set the indicator level to 100 % once you have exchanged an indicator bottle.

Installation



WARNING

Risks resulting from incorrect installation!

- Install Titromat® M2 at a location where it is protected against dripping or splash water, dust and aggressive substances – e.g. in a switch cabinet or on a suitable wall.



NOTE

Information for trouble-free operation

- Install Titromat® M2 vertically and without mechanical stress.
- Install Titromat® M2 at a vibration-free site.

Operating Titromat® M2 in the pressure range of 0.3 to 1 bar

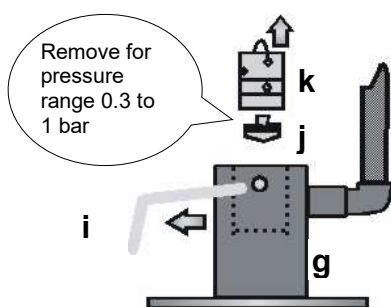

Prior to installation, please check whether lower operating pressure is required. The instrument is factory set for the operating range of 1 to 8 bar. Remove the flow controller valve body **j** to operate the instrument in the operating range of 0.3 to 1 bar (e.g. when using an aerator Type R). This involves removing the retaining pin **i** from the controller/filter receiver **g**. Subsequently use the metal bracket to remove the controller plug **k** from the borehole. Then remove the flow controller valve body **j** and reinsert the controller plug and the retaining pin.

Installing Titromat® M2

Select an installation site where the water inlet hose can be kept as short as possible (max. 5 m).

- Please leave sufficient space on the left-hand side of the instrument to open the door.
- Drill the mounting holes as shown in the drawing on the left.
- Use three screws to attach the instrument at a suitable position in the switch cabinet or on a wall.

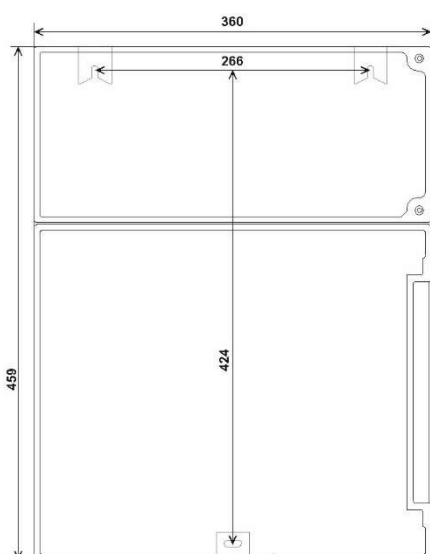

NOTE**Connecting the water inlet and outlet****Information for trouble-free operation**

- The water pressure must be between 0.3 bar and 8 bar
- Avoid strong pressure fluctuations
- The measuring water temperature must be between 10 °C and 40 °C
- For temperatures above 40 °C, a cooler should be installed in the branch line of Titromat® M2.

Water inlet

The measuring water is taken from the main water line of the water treatment plant and fed to the inlet connection of Titromat® M2. The instrument is equipped with a plug connector for plastic hoses 6/4 x 1 (external diameter 6 mm/ internal diameter 4 mm, wall thickness 1 mm) as standard.

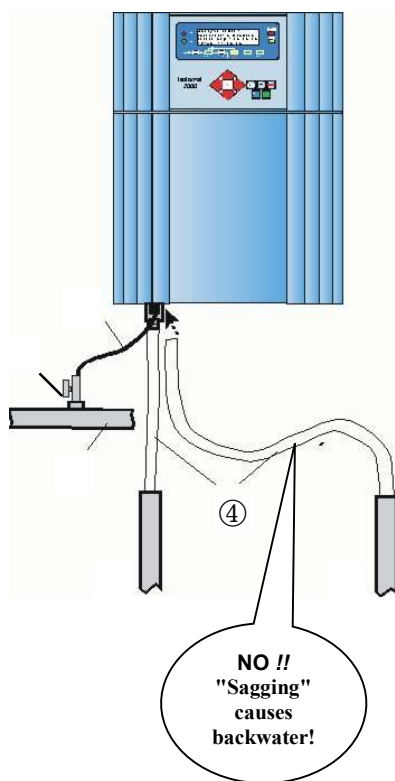

- Install the connection for the branch line of Titromat® M2 directly at the main water line directly after the water treatment plant
- It is important that the branch line connection is laid vertically upwards in order to prevent dirt particles from entering the instrument from the main water line.
- Install a manually operated shut-off valve in the branch to Titromat® M2.
- Use an opaque plastic hose 6/4 x 1 (max. length 5 m) for the water inlet .
- Flush the inlet to remove any dirt particles.

When operating within a pressure range of 0.3 to 1 bar or with a supply via a booster pump, please remove the valve body from the controller and the filter housing. The pump should have a feeding capacity of between 25 and 35 litres/hour and be resistant to the medium being measured.

**CAUTION****When using a cooler**

- The hot water can cause burns and damage wetted parts of Titromat® M2.

Water outlet

The feed water flows through the measuring chamber to the drain via the outlet hose.

- Connect the outlet connection of Titromat® M2 to an outlet hose④ (internal diameter 12 mm).
- Lay this hose without **backwater development** and any syphoning effect, e.g. via an open funnel, to the drain.

Connecting the power supply and devices



Risk of electric shocks during installation!

If the power supply is not disconnected prior to installation, it may result in personal injuries, destruction of the product or damage to plant parts.

- Always disconnect the relevant plant parts before installing Titromat® M2.
- Only use tested cables with sufficient cross-sections for the connections.



Risk of damages caused by electromagnetic fields!

- If Titromat® M2 or the connecting cables are installed parallel to power cables or in close proximity to electromagnetic fields, the instrument may be damaged or measurements incorrect.
- Ensure that connecting cables are as short as possible.
- Always install connecting cables and power cables separately.
- Connect the instrument to the protective earth conductor (for 230/115 VAC).
- Protect Titromat® M2 against interference voltages – e.g. by using a mains filter.
- Shield the instrument against strong electromagnetic fields.

Block diagram Titromat® M2

Drawn relay positions: Instrument de-energised

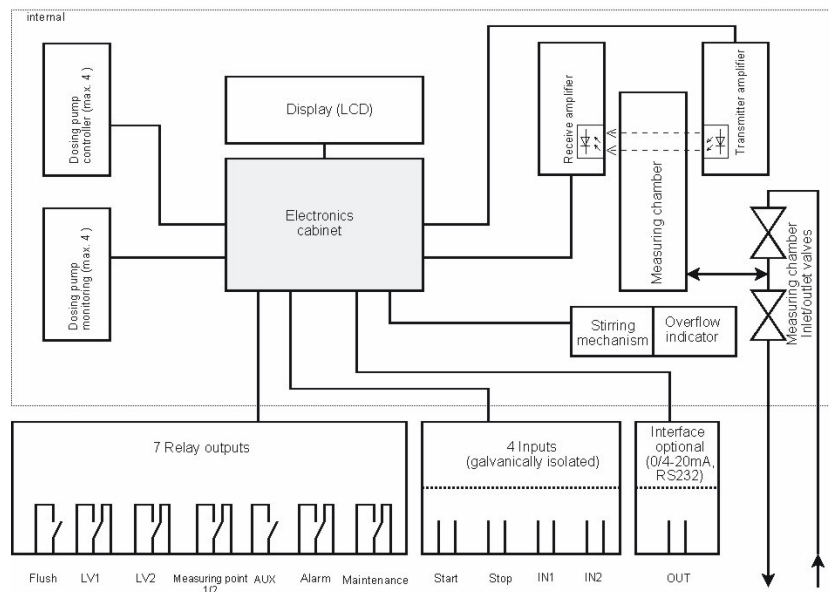

Internal design Titromat® M2

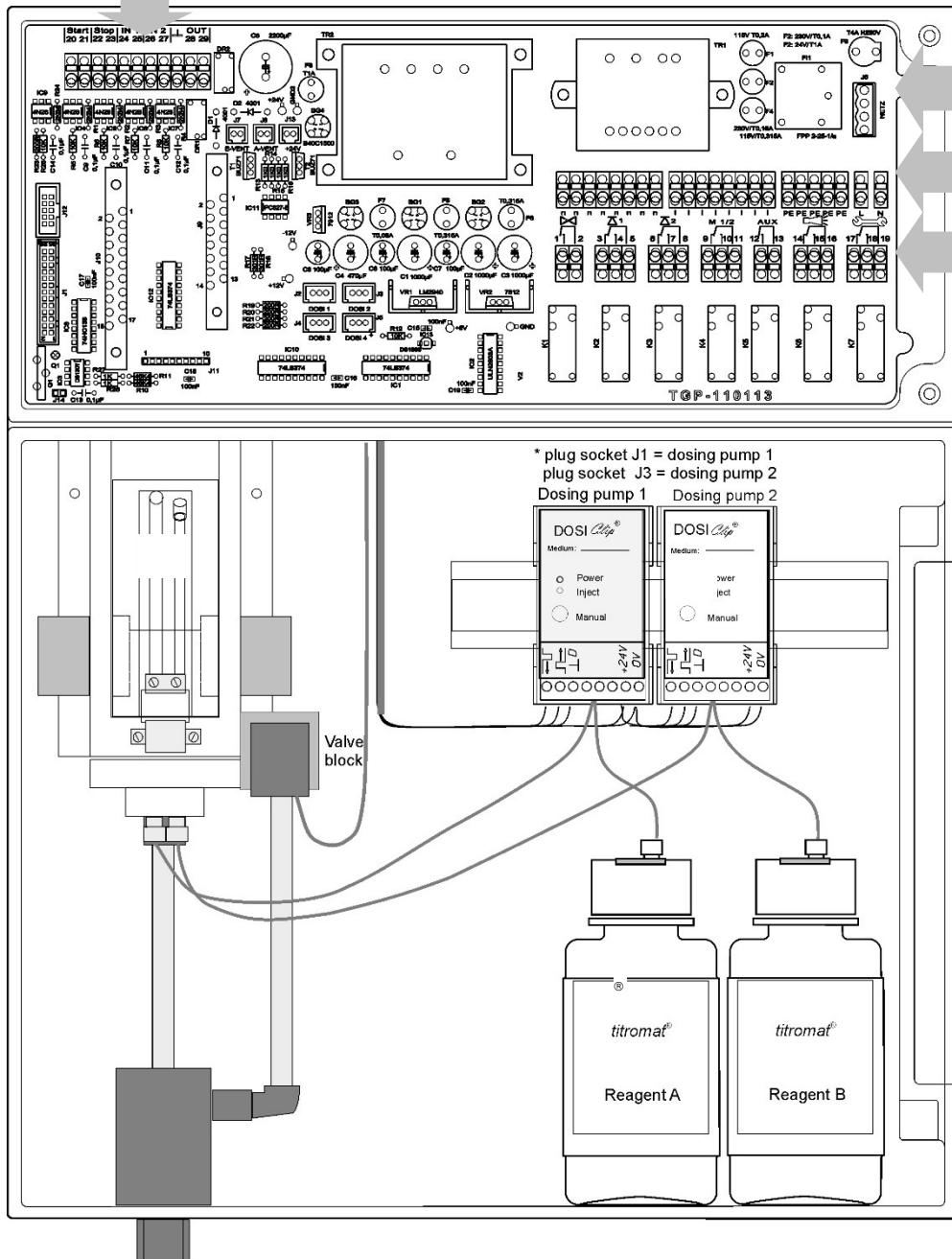

| | |
|---|---|
| | Terminal strip for inputs Start, Stop, IN1, IN2, and output OUT |
| | Mains switch |
| | Terminal strip for power input and power output |
| ④ | Terminal strip for relay outputs |
| | Dosing pump |
| | Water connections, inlet and outlet |
| | Controller / Filter receiver |
| | Measuring chamber |

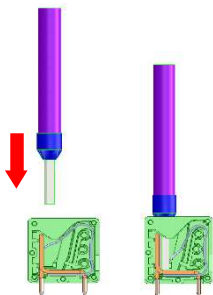
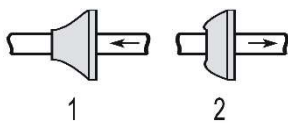

Insert the conductor with ferrule or the solid conductor into the round input.

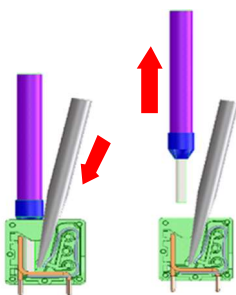

1. Insert a screwdriver into the square opening without force in order to open the terminal.
2. Once the terminal has been opened, remove the conductor.

Connecting the mains voltage

Only connect the instrument to the specified mains voltage. Refer to the rating plate for the appropriate mains voltage. Connect the cables as follows:

- Loosen both fastening screws and open the upper door. The terminal box is now accessible.
- Pierce the required rubber cable glands with a screwdriver and insert the cable through the bush into the terminal box (1)
- Subsequently pull back the cable until the bush has been turned over (2).
- Connect the power supply to terminals PE, N, L or for 24 V instruments to terminals U, V.
- Connect the conductor to the terminal block as shown on the left .
- Ensure that the leads are held securely in the terminals.
- Proceed as shown in figure to loosen the connection.

| Terminal | Type | Function | Comment |
|----------------|------|--|----------------------------------|
| PE | IN | Protective earth conductor (5x) | Only for mains 115/230 V ! |
| N (U) L (V) | IN | Mains, N= neutral conductor (U=24 V) Mains, L= phase (V=24 V) | Mains input 24 V / 115 V / 230 V |
| n l | OUT | Neutral, switched (8x) Phase, switched (8x) | Mains for consumers, max. 4 A |

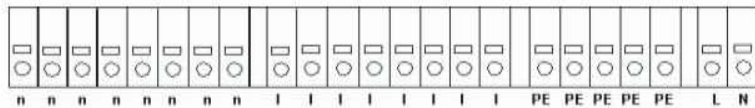

Connection example
Limit value contact LV 1
switches mains voltage

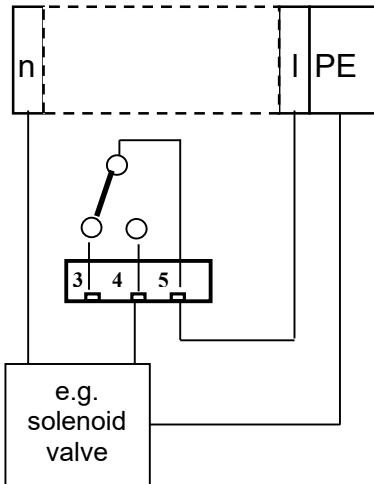

Connecting the plant components

- Connect the plant components to the output terminals of relays 1 to 19 (e.g. valves).
- If the plant components require mains voltage, connect the switched mains voltage (I) to the common contact of the respective relay (see the connection example for 230 VAC on the left).
- Connect the neutral conductor of the plant component to one of the terminals (n).
- For components with a protective earth conductor connection, connect it to the PE connection.
- Ensure that the leads are held securely in the terminals.

(Drawn relay positions: Instrument de-energised)

| No. | Terminal | Type | Function | Comment |
|----------------|----------------------|------|---|--|
| 1 2 | Flush | OUT | External flush valve | Isolated relay output, max. 240 VAC, 4 A |
| 3 4 5 | LV1 | OUT | Limit value output 1 – N/C Limit value output 1 – N/O Limit value output 1 - Common | Isolated relay output, max. 240 VAC, 4 A |
| 6 7 8 | LV2 | OUT | Limit value output 2 – N/C Limit value output 2 – N/O Limit value output 2 - Common | Isolated relay output, max. 240 VAC, 4 A |
| 9 10 11 | M. point. 1/2 | OUT | Measuring point 1 – N/C Measuring point 2 – N/O M. point switch-over - Common | Isolated relay output, max. 240 VAC, 4 A |
| 12 13 | AUX | OUT | Universal output | Isolated relay output, max. 240 VAC, 4 A |
| 14 15 16 | Alarm | OUT | Fault message output – N/C Fault message output – N/O Fault message output - Common | Isolated relay output, max. 240 VAC, 4 A |
| 17 18 19 | Maintenance | OUT | Maintenance message – N/C Maintenance message – N/O Maintenance message - Common | Isolated relay output, max. 240 VAC, 4 A |

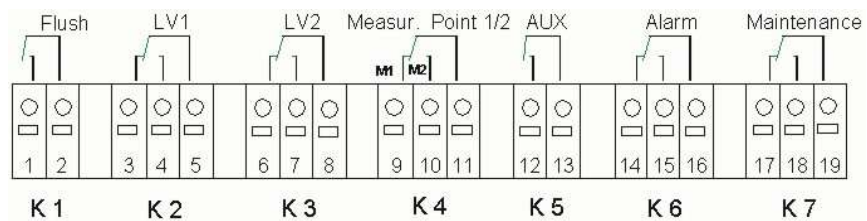

Connecting the inputs and outputs

Titromat® M2 has the following connections for control and monitoring functions.

- Do not connect an external voltage to these connections!
- Ensure that the leads are held securely in the terminals.
- Use the two fastening screws to close the upper door once installation has been completed.

| No. | Terminal | Type | Function | Comment |
|----------|--------------|------|--|---|
| 20 21 | Start | IN | External analysis start common earth for inputs | Only connect isolated normally open contact! |
| 22 23 | Stop | IN | External analysis stop common earth for inputs | Only connect isolated normally closed/open contact! |
| 24 25 | IN1 | IN | Universal input 1 common earth for inputs | Only connect isolated normally closed/open contact! |
| 26 27 | IN2 | IN | Universal input 2 (water meter) common earth for inputs | Only connect isolated normally open contact! |
| ⊥ | | | RS 910: Earth | RS232 interface |
| 28 | OUT | OUT | SK910: (+) | Galvanically separated current interface 0/4 - 20mA |
| | | OUT | UK910: (+) | Galvanically separated voltage interface 0/2 – 10V |
| | | OUT | RS910: (TxD) | RS232 interface |
| 29 | OUT | OUT | SK910: (-) | Galvanically separated current interface 0/4 - 20mA |
| | | OUT | UK910: (-) | Galvanically separated voltage interface 0/2 – 10V |
| | | IN | RS232: (RxD) | RS232 interface |

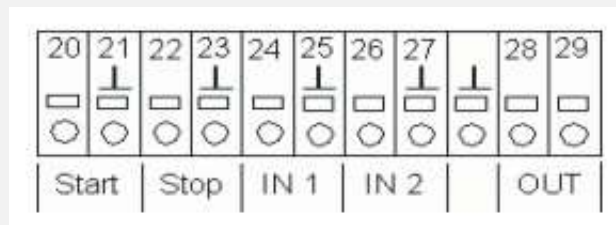

For more information, please refer to the section entitled "Description of the signal inputs/outputs".

Commissioning



Handling of reagents/indicators

- Adhere to the respective safety data sheet!
- Trouble-free operation of Titromat® M2 is only guaranteed when using Heyl Titromat® M2 indicators!

Inserting the indicator bottle

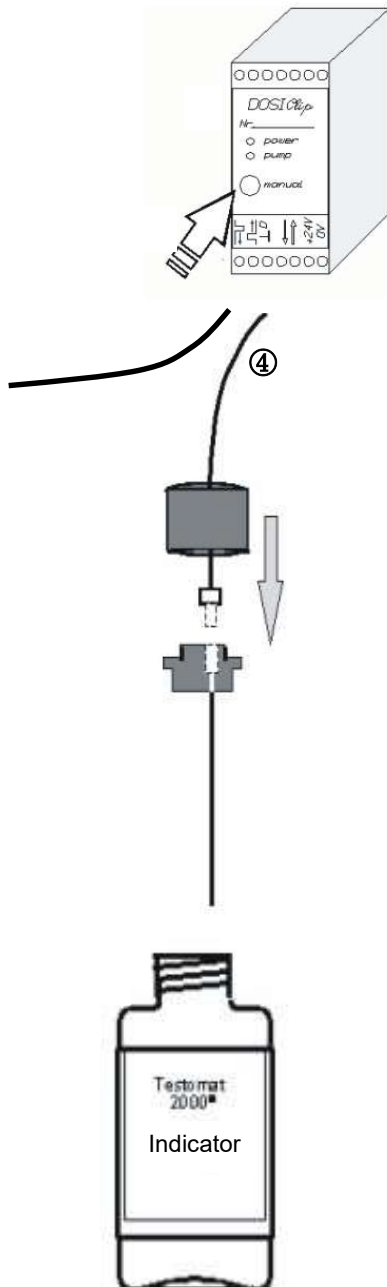

- Open the lower housing door by pulling on the right-hand side.
- Remove the cap from the indicator bottle.
- Remove the plastic bag from inside the lower housing door. The plastic bag contains the screw cap with hole and the insert for the screw cap.
- Connect the parts as shown on the left.
- Screw the hose connector of the intake hose (4) hand-tight into the insert.
- Place the insert with the screwed-in intake hose into the indicator bottle.

Now screw the screw cap with hole hand-tight onto the indicator bottle.

Extracting the indicator

- Switch the instrument on and press the "STANDBY" key.
- During operation, the pump (DOSIClip) automatically extracts indicator.
- To ensure that indicator is available for the initial analyses, the intake hose (4) and the transport hose must be filled with indicator from the pump up to the measuring chamber.
- Press the "manual" key several times until the intake hose (4) and the transport hose are filled with indicator up to the measuring chamber (always switch on the instrument at the mains switch first!)

If necessary, manually tighten the hose connectors of the intake and transport hose slightly in case of bubble formation.

Opening the water inlet

- Open the lower housing cover.
- Slowly open the manually operated shut-off valve to prevent the measuring chamber overflowing. The flow regulator requires a few seconds to function correctly.
- Make sure that the water conducting parts are not leaky.

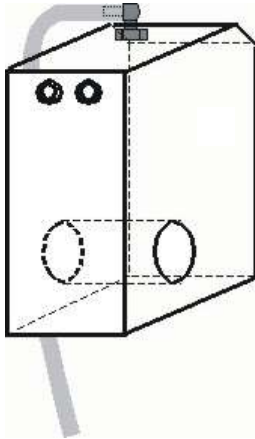

- If water sprays from the tube of the measuring chamber, reduce the amount of inlet water via the manually operated shut-off valve. It should take 2 to 6 seconds to fill the measuring chamber!

Instrument settings and data input

- Please read the following information before carrying out settings and entering data for operating the instrument.

Functions of the operating and display elements

The Titromat® M2 display shows operating statuses and measured values. The input keys for programming (cursor block) and the function keys are located underneath the display.



Switching Titromat® M2 on/off

- (1) Mains switch
Use this switch to switch the instrument on or off.
- (2) Instrument fuse (inside the instrument)
This fuse protects Titromat® M2 and the outputs against overloads and short circuits.

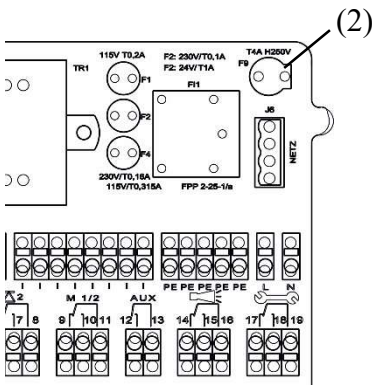

Display functions

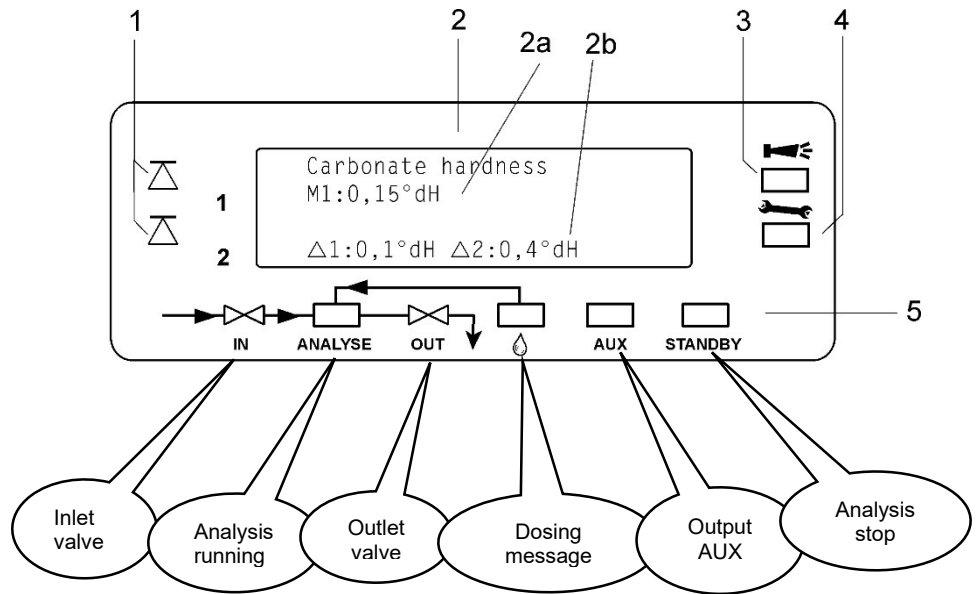

1 Limit value status displays (red/green)

The display 1 illuminates red if limit value 1 has been reached or exceeded. The display 1 illuminates green if the value falls below the limit value. The same principle applies to limit value 2 and display 2.

2 Text display (4 lines)

Displays the current analysis result as well as all important statuses and programming data.

2a = The current measured value for measuring point 1 (M1) and 2 (M2) is displayed in line 2 and 3.

Value falls below the measuring range = "<"

e.g. M1: < 0.89 ppm CaCO₃

Value exceeds the measuring range = ">"

e.g. M1: > 35.7 ppm CaCO₃

2b = The set limit values LV1 and LV2 are displayed in line 4

3 Alarm (red)

Indicates malfunctioning/error message or warning message.

4 Maintenance message (yellow)

Indicates current maintenance requests

5 Status display of the active instrument components (line)

Six displays indicate the current instrument and analysis status

All error and warning messages are alternately shown in line 1 of the standard display!

NOTE

Cancelling error messages/warning messages

➤ Press  to acknowledge the message and, if necessary, eliminate the cause of the fault.

Operating elements and function keys

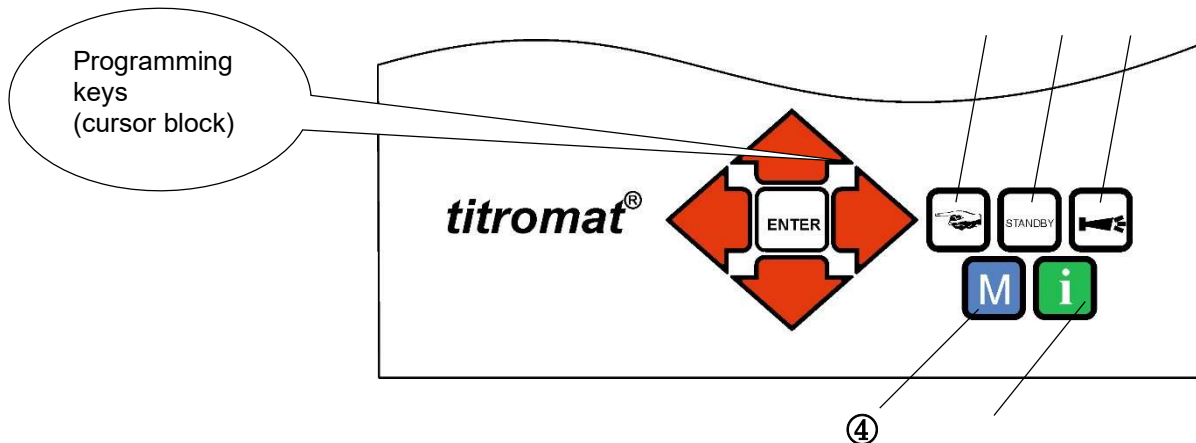

Function keys

| | |
|--|--|
| | Press the "manual" key to start an analysis by hand |
| | Press the "STANDBY" key to put the instrument into standby mode (automatic analyses are not carried out: analysis stop) |
| | Press the "Horn" key to acknowledge error and warning messages |
| | Press the "M" key ④ to open the programming menu for user specific and instrument specific settings |
| | Press the "i" key to call all instrument information and settings |

(M)enu key



Cursor block



If you wish to carry out settings or enter data, or if alterations are necessary, press the **"M" key** to open the programming mode. Use this key when *in the menu* to go to the higher order menu items or to exit the programming mode. Please note: The basic program is password protected!

Programming keys (cursor block)

Use the programming keys (cursor block) to navigate in the menu, to select the desired functions and to enter necessary instrument and plant specific data. Press the "ENTER" key to select the submenu item and to confirm and accept the selection or data input.

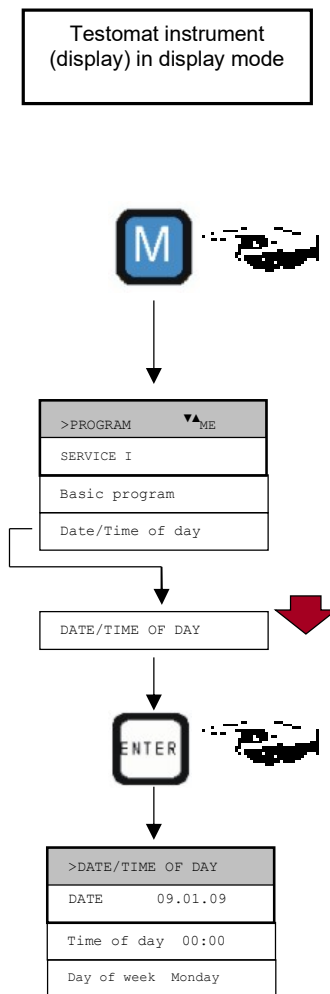

Operating system

Instrument settings and data input

Date, time and weekday input

➤ Press the "M" key

The basic menu ">PROGRAM" appears

➤ Use the cursor block to select the desired menu item "Date/Time of day"

The selection appears in CAPITAL LETTERS.

➤ Press "ENTER" to confirm your selection

The selected submenu ">DATE/TIME of day" appears

The menu item "DATE" has already been selected (capital letters)

➤ Press "ENTER" to confirm the menu item "DATE"

The cursor flashes in the date field: "29.01.09"

➤ Use the cursor keys to select the desired number

➤ Use the keys to move the cursor to the next input field

➤ Repeat this input process until the year has been entered

➤ Press "ENTER" to confirm the entry

The date has now been entered.

Exit the menu item "DATE" in order to set the time.

➤ Use the cursor block to select the desired menu item "TIME OF DAY"

➤ Press "ENTER" to confirm your selection

The cursor flashes at the first position of the time: "20:00"

➤ Use the cursor keys to select the desired number

➤ Use the keys to move the cursor to the next input field

➤ Repeat this input process until the seconds have been entered

➤ Press "ENTER" to confirm the entry

The time has now been entered.

Exit the menu item "TIME OF DAY" to set the weekday

➤ Use the cursor block to select the desired menu item "DAY OF WEEK"

➤ Press "ENTER" to confirm your selection

➤ Use the cursor block to select the selected weekday

➤ Press "ENTER" to confirm the entry

➤ Press the "M" key twice to end programming

The standard measured value display appears on the display

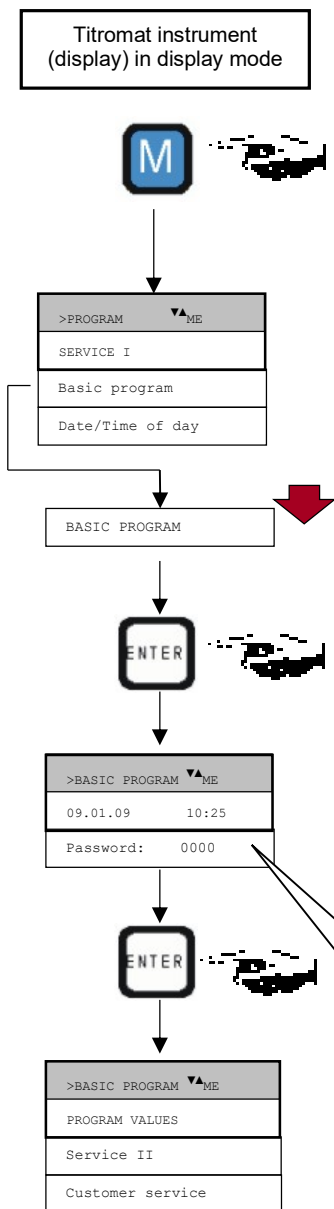

Password protection and basic program

A four-digit password is required to enter data and to carry out settings in the basic program. The password is the current time of Titromat® M2 in reverse order.

Password entry

- Press the "M" key
 - The basic menu ">PROGRAM" appears
- Use the cursor block to select the desired menu item "Basic program"
 - The selection appears in CAPITAL LETTERS.
- Press "ENTER" to confirm your selection
 - The selected submenu ">BASIC PROGRAM" appears
- Press "ENTER" to confirm the menu item "BASIC PROGRAM"
 - The cursor flashes in the "Password:" field 0000
- Use the cursor keys to enter the time in *reverse order*: "5201"
- Press "ENTER" to confirm the entry

The selection menu for the basic program appears. You can now enter the plant specific data.

Selecting the operating mode

Under the menu item "Mode of Operation" it is possible to select the type of analysis controller. Titromat® M2 provides numerous selection options: Time control, quantity control via water meter and external analysis start.

Time controlled
Internal start via a timer.

Shortest interval = 0 minutes between analyses. Largest interval = 99 minutes.

The analysis interval (time between two analyses) is determined by the duration of the supplementary program AUX, the set flush times (internal and external), the programmed interval and the duration of the analysis. The analysis duration depends **directly** on the measured value.

| | |
|--------------------------|---|
| >MODE OF OPERATION ▼▲ ME | |
| TIME CONTROLLED | * |
| Volume interval | |
| External (Start) | |

Selecting the time control

- In >BASIC PROGRAM, select
=> PROGRAM VALUES=> MODE OF OPERATION=> TIME CONTROLLED
- Press "ENTER" to confirm the selection
(An asterisk " * " appears at the end of the line)
("TIME CONTROLLED" " * " is preset)

| | |
|-----------------------------|------|
| >FLUSH TIMES/INTERVAL ▼▲ ME | |
| INTERNAL FLUSH TIME | 000s |
| External flush time | 00s |
| Interval pause | 01m |

Enter the interval pause and the flush times

- In >BASIC PROGRAM, select
=> PROGRAM VALUES=> FLUSH TIMES/INTERVAL
=> INTERVAL PAUSE
- Enter the "INTERVAL PAUSE" in minutes (m)
(1 minute is preset)
- Enter the "INTERNAL FLUSH TIME" in seconds (s)
(00 seconds (s) is preset)
- Enter the "EXTERNAL FLUSH TIME" in seconds (s)
(00 seconds (s) is preset)
- Press "ENTER" to complete all the entries

Analysis interval
Sequence of times

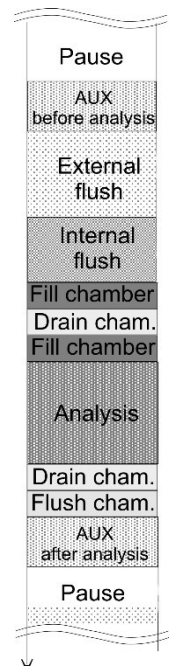

NOTE

Duration of the analysis interval

- The analysis interval is the addition of the "AUX before/after analysis", "Internal flush" and "External flush" times and the measuring value dependent analysis duration (see diagram on the left)

Volume controlled

Start via water meter

Minimum interval = 1 litre, maximum interval = 9999 litres. The analysis is carried out once the programmed water quantity has been measured. The line and the measuring chamber are flushed prior to the analysis (observe the programmed flush times).

| MODE OF OPERATION ▼▲ ME | |
|-------------------------|---|
| TIME-CONTROLLED | |
| Volume interval | * |
| External (Start) | |

Selecting the volume control

- In the >BASIC PROGRAM menu, select
=> PROGRAM VALUES=> MODE OF OPERATION=> VOLUME INTERVAL
- Press "ENTER" to confirm the selection
(An asterisk " * " appears at the end of the line)

| >VOLUME INTERVAL ▼▲ ME | |
|------------------------|--|
| 00001 | |
| | |
| | |

- The >VOLUME INTERVAL menu appears
- Enter the respective flow rate in litres
- Press "ENTER" to confirm the entry

| >TYPE OF WATER METER ▼▲ ME | |
|----------------------------|---|
| 1 LITRE/IMPULSE | |
| 2,5 Litres/Impulse | |
| 5 Litres/Impulse | |
| 10 Litres/Impulse | |
| 100 Litres/Impulse | * |
| 500 Litres/Impulse | |
| 1000 Litres/Impulse | |

Selecting the type of water meter

- Select the >BASIC PROGRAM menu
=>PROGRAM VALUES=> WATER METER=> TYPE OF WATER METER
- Select the water meter constant (litre/impulse)
(100 litres/impulse " * " is factory set)
- Press "ENTER" to confirm the selection

External analysis start

External analysis start

External analysis start occurs via a contact at the **start input**.

| >DISPLAYED UNIT ▼▲ ME | |
|----------------------------------|---|
| DISPLAY IN °dH | * |
| Display in °f | |
| Display in ppm CaCO ₃ | |
| Display in mmol/l | |

Selecting the display unit

It is possible to program the unit of the displayed value. The units dH, °f, ppm CaCO₃ and mmol/l can be selected. All the following inputs and displays will then be displayed in the programmed unit.

- In >BASIC PROGRAM, select
=> PROGRAM VALUES=> DISPLAYED UNIT
- Select the desired unit
- Press "ENTER" to confirm the selection

Entering further basic program data

For selecting and entering data for these functions, please proceed as described under "Entering basic program data".

Internal flushing

To ensure that the analysed sample represents the current value, the sampling line must be sufficiently flushed. If the plant has been out of operation for a longer period or in case of long analysis intervals, we recommend you to select a flushing time greater than 60 seconds. Flushing starts by simultaneously opening the inlet and the outlet valve of Titromat® M2.

NOTE

Duration of the analysis interval

- The analysis interval depends directly on the programmed flushing time. If, e.g., a flushing time of 90 seconds has been set, the actual analysis interval cannot be less than 90 seconds.

| >FLUSH TIMES/INTERVAL ▼▲ ME | |
|-----------------------------|------|
| INTERNAL FLUSH TIME | 000s |
| External flush time | 00s |
| Interval pause | 01m |

- In >BASIC PROGRAM, select
=> PROGRAM VALUES=> FLUSH TIMES/INTERVAL
- Enter the "FLUSH TIMES/INTERVAL" in seconds (s)
- Press "ENTER" to confirm the entry

NOTE

Setting the internal flushing time

- For connections longer than 3 m and with an internal hose diameter of 6 mm a minimum internal flushing time of 10 seconds is required to ensure that a valid sample is taken from the sampling line. The required quantity of flush water for one-minute internal flushing is 0.5 litres.

External flushing

If very short analysis intervals are required, or if a very long (several metres) sampling line or a line with a large diameter is used, an external flush valve should be installed upstream of Titromat® M2. The external flush valve has to be connected to the "Flush" outlet. If the unit is used for monitoring two measuring points, external flushing prevents incorrect measurements caused by sample mixing. The external flushing time for the valve depends, just as the flushing time for unit flushing does, on the length and diameter of the supply line to Titromat® M2.

| >FLUSH TIMES/INTERVAL ▼▲ ME | |
|-----------------------------|------|
| INTERNAL FLUSH TIME | 000s |
| External flush time | 00s |
| Interval pause | 01m |

- In >BASIC PROGRAM, select
=> PROGRAM VALUES=> FLUSH TIMES/INTERVAL
- Enter the "FLUSH TIME/EXTERNAL" in seconds (s)
- Press "ENTER" to confirm the entry

Interval pause

If the analysis is triggered via a timer, the interval between two analyses (plus flushing time) is determined by the interval pause. The shortest interval can be 0 minutes. In this case, analyses are carried out continuously. The longest interval is 99 minutes.

| >FLUSH TIMES/INTERVAL ▼▲ ME | |
|-----------------------------|------|
| INTERNAL FLUSH TIME | 000s |
| External flush time | 00s |
| Interval pause | 01m |

- In >BASIC PROGRAM, select
 - => PROGRAM VALUES=> FLUSH TIMES/INTERVAL
- Enter the "INTERVAL PAUSE" in minutes (m)
- Press "ENTER" to confirm the entry

Limit value monitoring

It is possible to program the limit values on a continuous scale. The limit value range depends on the used indicator type and the programmed unit. Two limit value outputs are available for monitoring. This ensures that two limit values or two measuring points can be monitored. The functions of the allocated relay outputs can be programmed independently of each other.

Monitoring of two limit values

If the unit is used for monitoring two *limit values*, the limit value outputs are permanently allocated to these limit values!

 1 LV1 = Limit value 1  2 LV2 = Limit value 2

Monitoring of two measuring points

If the unit is used for monitoring two *measuring points*, the limit value outputs are permanently allocated to these measuring points!

 1 LV1 = Measuring point 1  2 LV2 = Measuring point 2

If the limit value LV1 has been exceeded, the limit value control display  1 lights up **RED** and the relay output LV1 reacts as programmed in the switch function. If the limit value has not been exceeded, the display lights up GREEN. The same applies for the limit value LV2.

| >LIMIT VALUES ▼▲ ME | |
|---------------------|---------|
| LIMIT VAL. 1: | 0,25°dH |
| LIMIT VAL. 2: | 0,15°dH |
| | |

- In >BASIC PROGRAM, select
 - => PROGRAM VALUES=> LIMIT VALUES
- Enter the values for "LIMIT VALUE 1" or "LIMIT VALUE 2"
- Press "ENTER" to confirm the entry

Suppression of bad analyses

| >HYSTERESIS LV1 ▼▲ ME | |
|-----------------------|---|
| ANALYSIS (1,2,3) | 1 |
| | |
| | |

| >HYSTERESIS LV2 ▼▲ ME | |
|-----------------------|---|
| ANALYSIS (1,2,3) | 1 |
| | |
| | |

Hysteresis

The respective limit value output only switches after the first, second or third bad analysis (suppression of the first or the second measured value). This increases the reliability of the analysis evaluation, e.g. after the measuring point has been switched over or if the sampling line has not been flushed sufficiently. The hystereses of the two outputs LV1 and LV2 can be set independently of each other.

With a hysteresis of "2", the next analysis is immediately carried out when the limit value of this analysis has been exceeded for the first time. The respective output is only switched after the limit value of this analysis has been exceeded for a second time. With a hysteresis of "3", the respective output only switches when the limit value of this analysis has been exceeded for a third time. This setting is only reactivated once the value has fallen below the limit value!

(The basic setting for LV1 and LV2 is 1)

➤ In >BASIC PROGRAM, select

=> PROGRAM VALUES=> HYSTERESIS LV1 or HYSTERESIS LV2

➤ Enter the number of analyses

➤ Press "ENTER" to confirm the entry

Switch functions of the limit value outputs LV1 and LV2

Schematic representation of logic

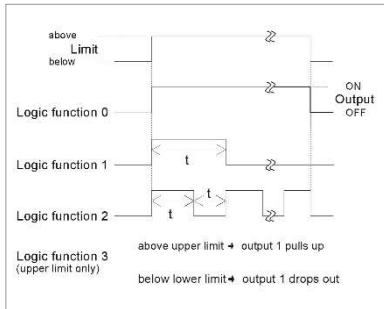

Switch function 0, duration

If the limit value LV1 or LV2 has been exceeded, the output relay LV1 or LV2 reacts. If the measured value falls below the limit value LV1 or LV2 without locking, the relevant relay drops out again.

Switch function 1, impulse

If the measured value exceeds the limit value LV1 or LV2, the relevant output switches for a settable time (t).

The respective output always remains switched for the set time, irrespective of how long the limit value has been exceeded. A new impulse is only possible once the value has fallen below the limit value!

Switch function 2, interval

If the limit value has been exceeded, the respective output switches at intervals with the settable time (t) = impulse or interval as long as the limit value is exceeded. The switching on time and the interval are the same.

Switch function 3, two-point

If the upper limit value LV1 has been exceeded, the output relay LV1 switches. If the value falls below the lower limit value LV2, the output relay LV1 drops out again. The output relay LV2 switches according to the programmed switch function.

| >FUNCTION LV1 | ▼▲ ME |
|---------------|---------|
| DURATION | * |
| Impulse | |
| Interval | |
| Two point | |
| Time | 00m:10s |

| >FUNCTION LV2 | ▼▲ ME |
|---------------|---------|
| DURATION | * |
| Impulse | |
| Interval | |
| Time | 00m:10s |

➤ In >BASIC PROGRAM, select

=> PROGRAM VALUES=> FUNCTION LV1 or FUNCTION LV2

➤ Select the duration, impulse, interval or two-point (only for LV1)

➤ Enter the time (only for switch function 1 and 2)

➤ Press "ENTER" to confirm the entry

The function 3 is only possible if different values are used for the limit values LV1 and LV2 with just **one** measuring point. For example, for LV1 = 0.2 °dH and for LV2 = 0.1 °dH.

Function IN1

When measuring from two measuring points, the automatic measuring point switch over can be suppressed by activating IN1. If IN1 is active, it is only measured from measuring point 2. If IN1 is inactive, it is only measured from measuring point 1. A respective control (e.g. timer) has to be connected to IN1 (volt-free contact required!). The active status of IN1 has to be programmed correspondingly. Please select function "2 external measuring points" in the menu under Measuring points.

| >FUNCTION IN1 ▼▲ ME |
|-------------------------|
| NORMALLY OPEN CONTACT * |
| Normally closed contact |

- In >BASIC PROGRAM, select
 - => PROGRAM VALUES=> FUNCTION IN1
- Select a normally closed or normally open contact
- Press "ENTER" to confirm the entry

Water meter

It is necessary to connect a water meter to **input IN2** for quantity-dependent analysis start, for dynamic analysis control and for monitoring the operation of the water treatment plant (plant monitoring). Program the corresponding water meter rating.

| >TYPE OF WATER METER ▼▲ ME |
|----------------------------|
| 1 LITRE/IMPULSE |
| 2,5 Litres/Impulse |
| 5 Litres/Impulse |
| 10 Litres/Impulse |
| 100 Litres/Impulse * |
| 500 Litres/Impulse |
| 1000 Litres/Impulse |

- In >BASIC MENU, select
 - => PROGRAM VALUES=> TYPE OF WATER METER
- Select the water meter rating
- Press "ENTER" to confirm the entry

Alarm/Message

The instrument is equipped with an alarm relay output for signalling faults. The events which mean a fault at the instrument or are intended to trigger a message, can either trigger an alarm "A" (continuous contact) or a message "M" (2-second impulse).

The faults are recorded and stored in the error history if the event has been programmed as an alarm or message. For example, if a low indicator level has not been programmed as an ALARM/MESSAGE, it is not registered in the error history. Up to 20 error messages can be stored. A list of these errors can be opened in the information menu. The information stored per event is the time (day, month, year and hour) and the type of the error.

| >ALARM/MESSAGE ▼▲ ME | | |
|----------------------|---|-------|
| REAGENT LOW LEVEL | A | A/M/- |
| Low water pressure | A | A/M/- |
| Mf. analysis | A | A/M |
| Ff. optics | A | A/M |
| Ff. dosing fault | A | A/M/- |
| Ff. dosing pump | A | A/M |
| Ff. outlet to drain | M | A/M |
| Mf. dirtiness | A | A/M/- |
| Power failure 24V | M | A/M |
| Mf. turbid | M | A/M/- |
| Meas. range exceeded | M | A/M/- |
| Maint. int. exceeded | M | A/M/- |

A=Alarm, M=Message
 - = no action
 Ff.=Function fault
 Mf.=Measuring fault

- In >BASIC PROGRAM, select
 - => PROGRAM VALUES=> ALARM/MESSAGE
- Select the type of monitoring A=alarm, M=message or - = no action for the individual menu items
- Press "ENTER" to confirm the respective entry

NOTE

Error messages

- All error messages are lost after a power failure.
- Certain instrument faults always trigger an alarm or a message!

Function AUX

The AUX relay output can be programmed for the following control functions:

- As a function output for the contact with programmable duration prior to and/or during the analysis, or after an analysis.

For example, it is possible to control the cooling water inlet of an upstream cooler via a solenoid valve. This ensures that the cooling water only flows when required, i.e. when an analysis is being carried out.

| | | |
|--------------------------|---------|-------|
| >FUNCTION AUX | | ▼▲ ME |
| CONTACT BEFORE ANALYS. * | | |
| Contact during analysis | | |
| Contact after analysis | | |
| Time: | 00m:10s | |

- In >BASIC PROGRAM, select
=> PROGRAM VALUES=> FUNCTION AUX
- Select the program step at which the AUX contact is to be activated
- Under "Time" enter the contact duration in minutes (m) and seconds (s)
- Press "ENTER" to confirm the entry

| | | |
|----------------------|-------|-------|
| >SERVICE II | | ▼▲ ME |
| CALIBRATION | | |
| RESET Operating time | | |
| Maintenance interval | | |
| Water quantity | RESET | |

Service II

The service II menu contains various functions for monitoring the operation of the instrument:

Programming of the maintenance interval, operation (reset) internal data/setting, e.g. water quantity and calibration.

NOTE

Use of the Service II menu

The functions in the Service II menu directly influence the operation and monitoring functions of the instrument and can result in plant malfunctioning!

- These tasks should only be carried out by trained and qualified staff.

Calibration

Calibration can, e.g., be carried out to compensate for negative influences caused by foreign ions. A standard solution or the value of the sample water determined via a laboratory analysis is required for this. You can either determine the correction factor and enter it directly or carry out calibration with a standard solution. In the latter case, the correction factor is calculated by the Testomat.

| >CALIBRATION | ▼▲ ME |
|---------------|---------|
| Calibr. value | 0.35°dH |
| Calibration | Start |
| Cal. factor | 1.0 |

1. Input of the correction factor from 0.1 to 2.00

- Carry out a current measurement and make a note of the measured value
- At the same time, take a water sample from the inlet of the Testomat instrument and check the measured value with a superior method
- Use the two values to determine the correction factor (laboratory value divided by the measured value Titromat®)
- In the >BASIC PROGRAM menu, select
=> SERVICE II => CALIBRATION
- Select the menu item "CORRECTION FACTOR"
- Press "ENTER" to confirm the selection
- Enter the determined correction factor
- Press "ENTER" to confirm the entry

2. Calibrating with standard solution

- In the >BASIC PROGRAM menu, select
=> SERVICE II => CALIBRATION

| >CALIBRATION | ▼▲ ME |
|---------------|---------|
| Calibr. value | 0.35°dH |
| Calibration | Start |
| Cal. factor | 1.0 |

- Select the menu item "CALIBRATION VALUE"
- Press "ENTER" to confirm the entry
- Enter the value of the standard solution
- Press "ENTER" to confirm the entry
- Stop the water supply to the instrument
- Remove the right-hand plug from the measuring chamber (The measuring chamber is manually filled with the standard solution through this borehole. Common laboratory spray bottles can be used for this.)

- In the >BASIC PROGRAM menu, select
=> SERVICE II => CALIBRATION

| Δ 1 | CALIBRATION |
|-----|-------------------------|
| Δ 2 | Calibr. Value: 0,30°dH |
| | Calibration Start |
| | Calibration factor: 1.0 |

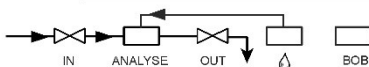

- Select the menu item "CALIBRATION START"
 - Press "ENTER" to confirm the selection
- Titromat® starts with an analysis cycle. If a flushing time has been programmed, do not fill the measuring chamber until the output valve has closed ("OUT" LED extinguishes).

- When the "IN" LED lights up, fill the measuring chamber with the standard solution until it overflows as long as the "IN" LED illuminates

The solution is then drained (flushing the measuring chamber).

- Once the output valve has closed ("OUT" LED extinguishes), refill the measuring chamber with the standard solution until it overflows.

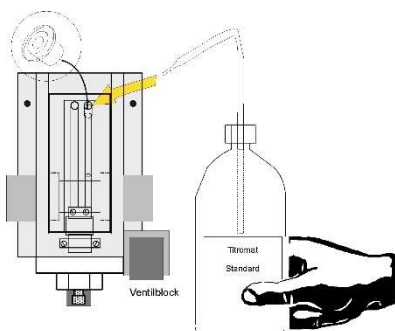

The filling level falls to the intended sample volume. The measured value is determined and the correction value is calculated. The factor is shown on the display.

NOTE

Using the calibration function

- If data is entered incorrectly or calibration is carried out incorrectly with a standard solution, it will result in incorrect measured values!

If an error occurs during analysis, the error message "Calibration terminated" appears; a (new) factor is not calculated.

Reset operating time

After replacing a dosing pump or the measuring chamber holder, it is possible to reset the current operating time to 0 hours.

| |
|-----------------------|
| >OPERATING TIME ▼▲ ME |
| 000023h |
| Reset |
| |

- In >BASIC PROGRAM, select
 - => SERVICE II=> RESET OPERATING TIME
- Select "Reset" to reset the operating time
- Press "ENTER" to confirm the selection

The operating time "000000h" appears on the display

Maintenance interval

Observance of the maintenance intervals is monitored and displayed by Titromat® M2. Program the desired maintenance interval in days here. (0 days equals no maintenance interval)

| |
|-----------------------------|
| >MAINTENANCE INTERVAL ▼▲ ME |
| |
| 000d |
| |

- In >BASIC PROGRAM, select
 - => SERVICE II=> MAINTENANCE INTERVAL
- Enter the maintenance interval in days (d)
- Press "ENTER" to confirm the entry

| |
|----------------------|
| >SERVICE II ▼▲ ME |
| CALIBRATION |
| RESET Operating time |
| Maintenance interval |
| Water quantity RESET |

Water quantity RESET

Causes a reset of the currently stored water quantity.

Description of the signal inputs/outputs



CAUTION

Connecting the signal inputs

- Only connect the signal inputs "Start", "Stop", "IN1" and "IN2" with *volt-free contacts!*

The connection of external voltages would damage the instrument!

Start
terminals 20,21

| Function | Test period | Action |
|--|-------------|--|
| Start External analysis start (only normally open) | None | In the operating mode EXTERNAL, an impulse contact at the input starts an individual analysis, while with permanent contact one analysis after the other is run. |

Stop
terminals 22,23

| Function | Test period | Action |
|--|-------------|--|
| Stop External analysis stop (e.g. via flow controller or process controller) | None | There are no analyses while the contact at the input is open or closed |

An active Stop input prevents an analysis start, e.g. via a current interval. This can be necessary if the plant does not supply water. A current analysis is stopped when the input valve is opened (while the measuring chamber is being flushed or filled). The water which has already entered the measuring chamber remains there. If the measuring chamber is already full, the analysis is executed. Manual start has priority over the Stop input, i.e. if the Stop input is active, an analysis can be started manually or a manually started analysis cannot be stopped by the stop signal. In the operating mode "time-controlled", the interval time continues when the Stop input has been activated.

| |
|---------------------------|
| >FUNCTION STOP ▼▲ ME |
| NORMALLY OPEN CONTACT |
| Normally closed contact * |
| |

- In >BASIC PROGRAM, select
=> PROGRAM VALUES=> FUNCTION STOP
- Select the type of contact
- Press "ENTER" to confirm the selection

IN1 terminals 24,25

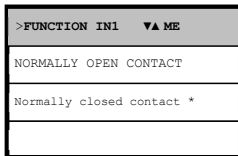

| Function | Test period | Action |
|--|-------------|--|
| IN1 External change-over of measuring point (for selection of the active measuring point) (Normally closed or normally open) | None | Contact active: Analyses only from measuring point 2 Contact not active: Analyses only from measuring point 1 |

- In >BASIC PROGRAM, select
 - => PROGRAM VALUES=> FUNCTION IN1
- Select the type of contact
- Press "ENTER" to confirm the selection

IN2 terminals 26,27

| Function | Test period | Action |
|---------------------------------|-------------|--|
| IN2 Water meter input | None | Quantity recording for analysis start and plant monitoring |

OUT terminals 1, 28,29

| Function | Connection | Action |
|---|------------------------------|--|
| OUT Programmable current interface 0-20 mA or 4-20 mA | Max. load 500 Ohms | programmable - Measured value measuring point 1 or 2 |
| OR Programmable voltage interface 0-10 V or 2-10 V | | with setting 0/4mA: 0/2V -20mA: 10V |
| OR Serial interface RS 232 | Serial bus (2-wire cable) | See description of interface card RS 910 |
| Refer to the section entitled "Interfaces" for a detailed description | | |

Interfaces (optional)

Current interface 0/4-20 mA

NOTE

Current interface load

- The maximum load of 500 Ohms should not be exceeded!
In case of possible faults and when using very long cables (approx. 20 m), a screened cable should be used, if possible.

Installing the interface cards SK910/RS910



WARNING

Avoid static charges during installation!

Personnel responsible for installation must be appropriately trained and qualified!

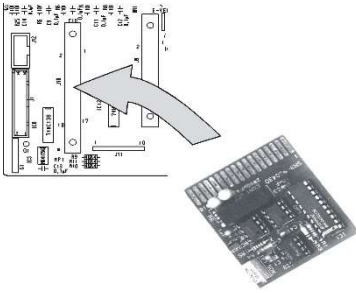

- Switch off the instrument.
- Insert the plug-in circuit board into the left-hand slot with the component side on the left. (Contact no.1 is at the top)
- Switch on Titromat® M2.
- Program the desired type of current (0/4-20mA) (for SK910).

Example 1 measuring point, Interface 0 - 20 mA or 2 measuring points external

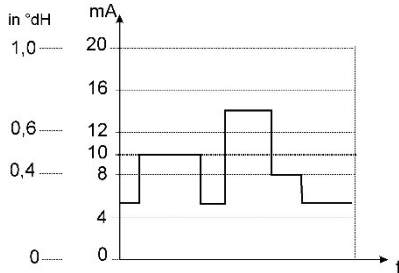

| >INTERFACES ▼▲ ME | |
|-------------------|---|
| TYPE 0-20mA | * |
| Type 4-20mA | |
| Type RS232 | |
| Type Data logger | |

| >MEASURING POINTS ▼▲ ME | |
|-------------------------|---|
| 1 MEASURING POINT | * |
| 2 Measuring points int. | |
| 2 Measuring points ext. | |

Monitoring a measuring point

A printer can be connected to record the analysis results. The instrument is equipped with a programmable current output for this purpose (optional 0-20 mA or 4-20 mA).

The example on the left displays the current profile in the 0-20 mA range for one measuring point.

- In >BASIC PROGRAM, select
 - => PROGRAM VALUES=> INTERFACES
- Select the desired current range
- Press "ENTER" to confirm the selection

- In >BASIC PROGRAM, select
 - => PROGRAM VALUES=> MEASURING POINTS 1 or 2
- Select the desired configuration
- Press "ENTER" to confirm the selection

Monitoring of two measuring points

The example on the left displays the current profile for 4 - 20 mA and the use of two measuring points.

Measuring point 1 and measuring point 2 are measured alternatively.

The measured value 1 is shown in display line 2 (M1:) and the measured value 2 in line 3 (M2:). The currently analysed measuring point is indicated by an asterisk on the right.

The range of the current interface is divided. The range 4 – 12 mA is available for the measured value from measuring point 1 and range 12 – 20 mA for the measured value from measuring point 2.

Example 2 measuring points, internal Interface 0 - 20 mA

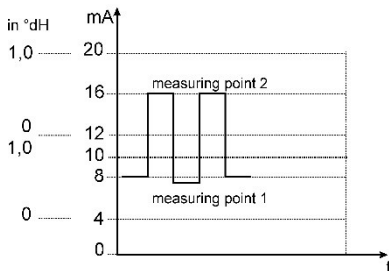

| >INTERFACES ▼▲ ME | |
|-------------------|---|
| Type 0-20mA | |
| TYPE 4-20mA | * |
| Type RS232 | |
| Type Data logger | |

| >MEASURING POINTS ▼▲ ME | |
|-------------------------|---|
| 1 MEASURING POINT | |
| 2 Measuring points int. | * |
| 2 Measuring points ext. | |

- In >BASIC PROGRAM, select
 - => PROGRAM VALUES=> INTERFACES
- Select the desired current range
- Press "ENTER" to confirm the selection

- In >BASIC PROGRAM, select
 - => PROGRAM VALUES=> MEASURING POINTS 1 or 2
- Select the desired configuration
- Press "ENTER" to confirm the selection

How is the current calculated for a specific measured value?

1 measuring point
0 - 20 mA

$$\text{Current} = \frac{\text{Measured value}}{\text{Maximum value}} \times 20 \text{ mA}$$

1 measuring point
4 - 20 mA

$$\text{Current} = \frac{\text{Measured value}}{\text{Maximum value}} \times 16 \text{ mA} + 4 \text{ mA}$$

2 measuring points
0 - 20 mA

$$\text{Current 1} = \frac{\text{Measured value 1}}{\text{Maximum value}} \times 10 \text{ mA}$$

$$\text{Current 2} = \frac{\text{Measured value 2}}{\text{Maximum value}} \times 10 \text{ mA} + 10 \text{ mA}$$

2 measuring points
4 - 20 mA

$$\text{Current 1} = \frac{\text{Measured value 1}}{\text{Maximum value}} \times 8 \text{ mA} + 4 \text{ mA}$$

$$\text{Current 2} = \frac{\text{Measured value 2}}{\text{Maximum value}} \times 8 \text{ mA} + 12 \text{ mA}$$

Measuring range not achieved (e.g. <0.05 °dH)

The current is set to 0 or 4 mA (for 1 measuring point)

Measuring range exceeded (e.g. >0.5 °dH)

The current is set to 20 mA.

Measured value = The value shown on the display in the selected hardness unit

Maximum value = The end value of the applied indicator (2.0 °dH)

Serial interface RS232

Titromat® M2 can also be connected to a log printer via the serial interface RS232 to enable the printout of measuring results and error messages. Analyses can then be continuously logged. This option is only possible in connection with the RS232 interface card for log printer, RS910 (Art. no. 270310).

| >INTERFACES | ▼▲ ME |
|------------------|-------|
| Type 0-20mA | |
| Type 4-20mA | |
| TYPE RS232 | * |
| Type Data logger | |

➤ In >BASIC PROGRAM, select

=> PROGRAM VALUES=> INTERFACES

➤ Select the desired interface

➤ Press "ENTER" to confirm the selection

SD card data logger

With the SD card data logger (article number 100490), the measurements of the Titromat® M2 can be logged continuously.

To operate the data logger, please proceed as follows:

| >INTERFACES ▼▲ ME |
|--------------------|
| Type 0-20mA |
| Type 4-20mA |
| Type RS232 |
| TYPE DATA LOGGER * |

- In >BASIC PROGRAM, select
 - => PROGRAM VALUES=> INTERFACES
- Select "Type Data logger".
- Press "ENTER" to confirm the selection

Description of the relay outputs

All relay outputs are neutral contacts. This ensures that all connection options are available. The switching of mains voltage and external voltage, and the direct switching of inputs, e.g. a process controller, can be realised.

Flush valve
terminals 1, 2

Flushing (external flush valve)

Immediately before each analysis the external flush valve is opened for the programmed period allowing the line up to Titromat® M2 to fill with measuring water. Please ensure that the programmed flush time is sufficient.

Please refer to "Entering further basic program data" → "External flush" for programming details

LV1 and LV2 limit value outputs

Two volt-free relay contacts are available to signal that a limit value has been exceeded. The limit values, the hysteresis and the switch function can be freely programmed for both contacts.

Limit value 1
terminals 3, 4, 5

| Function | Contact | Action |
|--|-------------------------------|--|
| LV1 Relay switches when the limit value is exceeded at: Limit value 1 or measuring point 1 | Volt-free change-over contact | Programmable: <ul style="list-style-type: none"> - Continuous contact - Impulse (1-99 seconds/minutes) - Interval (1-99 seconds/minutes) - Two-step controller (only for one measuring point) - Hysteresis (limit value is exceeded once, twice, three times) |

Limit value 2
terminals 6, 7, 8

| Function | Contact | Action |
|--|-------------------------------|---|
| LV2 Relay switches when the limit value is exceeded at: Limit value 2 or measuring point 2 | Volt-free change-over contact | Programmable: - Continuous contact - Impulse (1-99 seconds/minutes) - Interval (1-99 seconds/minutes) - Hysteresis (limit value is exceeded once, twice, three times) |

Please refer to the section entitled "Switch functions of the limit value outputs LV1 und LV2" for more details and programming!

Measuring points 1 or 2 (measuring point switch-over)

M. point switch-over
terminals 9, 10, 11

If the instrument is used for monitoring two measuring points, the solenoid valves (individual valves or one 3/2-way control valve) of the corresponding sampling line have to be connected to this output. The terminals are strictly allocated to the measuring points.

Terminal 9 = Measuring point 1 , Terminal 10 = Measuring point 2

| >MEASURING POINTS ▼▲ ME |
|---------------------------|
| 1 Measuring Point |
| 2 Measuring points int. * |
| 2 Measuring points ext. |

➤ In >BASIC PROGRAM, select

=> PROGRAM VALUES=> MEASURING POINTS 1 or 2

➤ Select "2 Measuring points"

➤ Press "ENTER" to confirm the selection

AUX (programmable function output)

The functioning of this volt-free relay output is programmable:

1. For reporting a current analysis and/or
2. For contact prior to an analysis, e.g. to operate with a cooler or
3. Contact after an analysis

AUX
terminals 12, 13

| >FUNCTION AUX ▼▲ ME |
|--------------------------|
| CONTACT BEFOR ANALYSIS * |
| Contact during analysis |
| Contact after analysis |
| Time: 00m:10s |

➤ In >BASIC PROGRAM, select

=> PROGRAM VALUES=> FUNCTION AUX

➤ Select the program step at which the AUX contact is to be activated

➤ Under "Time" enter the contact duration in minutes (m) and seconds (s)

➤ Press "ENTER" to confirm the entry

Alarm

terminals 14, 15, 16

The following faults activate the "Alarm" output and are displayed:

Always fault message for:

Power failure
 Low water level
 Function fault optics
 Measuring fault analysis
 Function fault dosing pump
 Function fault drain outlet
 Function fault failure 24V

Programmable fault messages for:

Low reagent level
 Function fault dosing error
 Function fault soiling
 Measuring fault turbid
 Measuring range exceeded
 Maintenance exceeded

Alarm (fault message output)

The "Alarm" output is a volt-free change-over relay contact. During trouble-free operation, the contact between the terminals 15 – 16 is closed and the one between terminals 14 – 16 is open. In case of a voltage breakdown, the contact between the terminals 14 – 16 is closed and the one between terminals 15 – 16 is open.

The instrument is equipped with a range of monitoring functions. You can define the individual statuses as a fault and program the corresponding message either as a continuous contact (A) or as a message impulse (M).

Functions/Behaviour of the "Alarm" output:

- With a continuous contact, the "Alarm" output remains activated (terminals 14 – 16 closed) as long as the fault persists.
- With a message impulse, the output is switched 'on' for 2 seconds and then switched 'off' for 5 seconds.
- If several faults with differently programmed messages are signalled simultaneously, the output is switched to continuous contact.
- The red LED "Alarm" and the text on the display indicate a fault.
- The fault message signal at the "Alarm" output is deleted by confirming the fault via the "Horn" key.
- The error message can only be deleted if the fault has been eliminated.
- Exception: The maintenance has been exceeded. This message is confirmed in the M menu, see below (Maintenance).
- Each new fault is entered into the error history (also see "i menu").
- There is **no** additional alarm via the fault message output when the limit value is exceeded!

The error messages are described under "Error messages/Troubleshooting"

Maintenance

terminals 17, 18, 19

Activation of the maintenance output for:

Low reagent level
 Function fault dosing error
 Function fault soiling
 Maintenance date reached

Maintenance (output for maintenance message)

The "Maintenance" output is a volt-free change-over contact. During trouble-free operation without a programmed maintenance interval, the contact between the terminals 17 – 19 is closed and the one between terminals 18 – 19 is open.

The instrument is equipped with a range of monitoring functions and a programmable maintenance interval. The respective maintenance message is always a continuous contact.

A maintenance request is displayed via the yellow "Maintenance" LED. The maintenance display can only be deleted once the status has been corrected or after the maintenance request has been confirmed.

Please refer to the section "Password protection and basic programming" for further programming details.

Information menu "i"

In the information menu, it is possible to request active settings and statuses of the instrument, the error history, the date for the next maintenance and the customer service address.

Call (1)

Use the  key to open the information menu "i".

Request options: Customer service, operating values, program values, error history, maintenance

Customer service (2)

Display of the customer service address or, e.g., a service hotline.

You can freely program these lines in the basic program (password protected).

Operating values (3)

Display of current values.

Program values (4)

Use the arrow buttons to call the menu item "Program values". Press "ENTER" to open the list of set values. The current setting of a parameter can be requested via "ENTER",

An asterisk indicates the selected functions. (There are no active lines)

Error history (5)

Use the "i" and "ENTER" keys to open the error history. The error history is a list of errors or statuses which have occurred during operation. The list is deleted after a power failure and a new list is started.

If no errors have occurred since start-up, the last switch-on time of the unit is displayed, e.g.:

POWER FAILURE
from 16.06.09 06:56
to 16.06.09 07:09

Maintenance (6)

Display of the next maintenance date and the programmed maintenance interval. It is possible to set the maintenance interval in the basic program (password protected).

Refer to the section entitled "Maintenance" for further details on maintenance intervals.

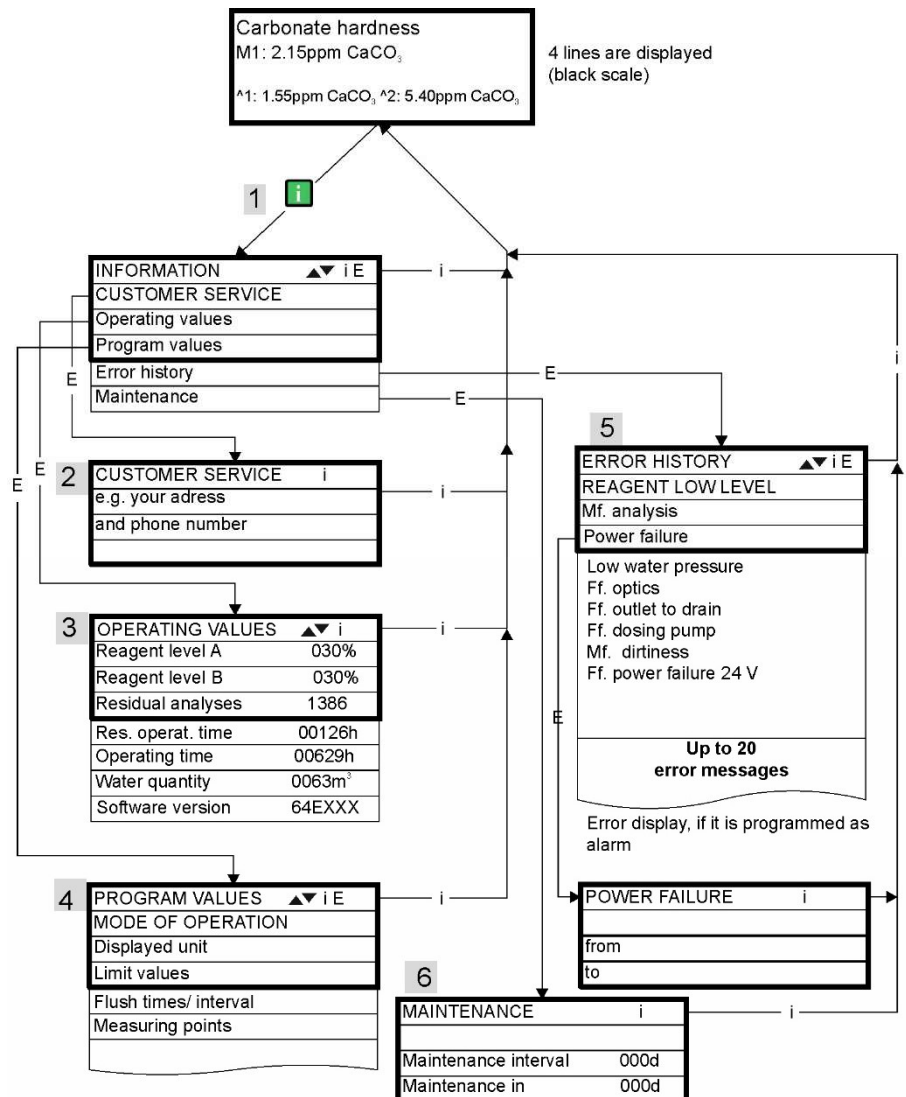

Please refer to the section "Password protection and basic programming" for further programming and setting details for the individual menu items

Service I (2)

Input reagents (3)

Enter the new filling levels after each refill or reagent bottle change. Once you have selected the menu item for entering the filling level "Reagent level: (0 - 100%)" via the "ENTER" key, the value is preset to 100%. If you have connected a full bottle, press "ENTER" to confirm the value. If the filling level of the bottle differs, enter the corresponding value.

Manual operation (4)

After confirming the information message (4) via the "ENTER" key, it is possible to select and activate the desired function by using the arrow keys and pressing the "ENTER" key. These functions are used for checking the functions and for commissioning.

Flush (5)

Start the flushing of the sampling tube through the internal valve by pressing "ENTER". When "ENTER" is pressed again, this function is terminated.

Flush chamber (6)

Press the "ENTER" key to flush the measuring chamber once.

Drain chamber (7)

Press the "ENTER" key to open the outlet valve in order to drain the water from the measuring chamber. Press the "ENTER" key again to cancel this function.

Fill chamber (8)

Press the "ENTER" key to fill the measuring chamber.

Program menu "M"

Call: (1)

Use the **M** key to open the program menu "M".

It is possible to call up all the functions without password protection except for the basic program.

Programming of: Indicator, manual mode, flushing, flush chamber, drain chamber, fill chamber, self-test, confirm maintenance, diagnosis, date, time, basic program with password

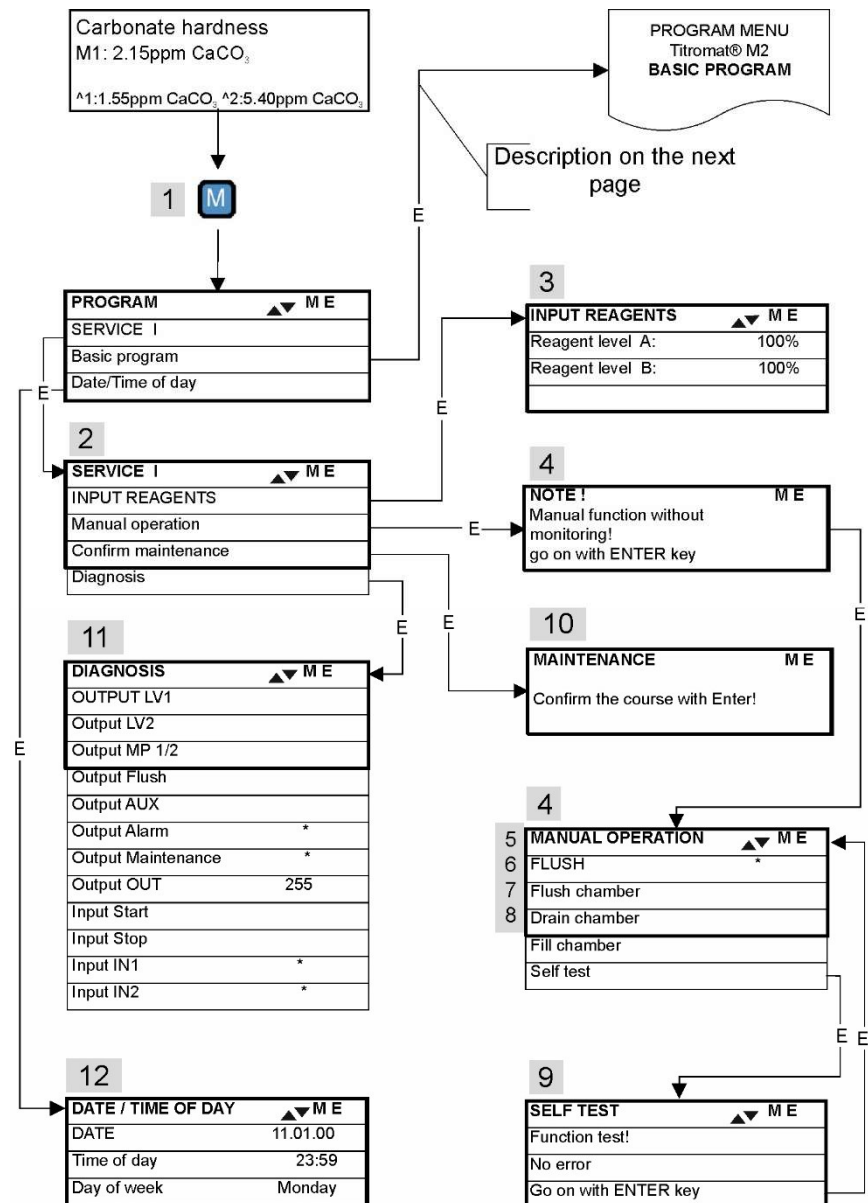

NOTE

Availability of functions

- All manual functions can only be selected during an analysis pause. Analyses are not carried out during manual operation. All signal inputs and outputs are locked.

| | |
|----------------------|-------|
| >SELF-TEST | ▼▲ ME |
| FUNCTION TEST! | |
| No error | |
| Go on with enter key | |

Self-Test (9)

Press "ENTER" to start the functional test of Titromat® M2. The program checks all relevant instrument functions and carries out an analysis. A respective message appears after an error-free test.

Press the "ENTER" key again to cancel this function and to return to the "MANUAL MODE" menu.

| | |
|------------------------------------|----|
| >Maintenance | ME |
| Press ENTER to confirm the process | |

Confirm maintenance (10)

After maintenance has been carried out, confirm it by pressing the "ENTER" key and exit this item via the "M" key. The maintenance interval is restarted.

Confirm a maintenance request once the maintenance interval has expired in the M menu. The displayed message is deleted and the "maintenance" output reset.

Refer to the section entitled "Maintenance" for further details on maintenance intervals.

| | |
|--------------------|-------|
| >DIAGNOSIS | ▼▲ ME |
| OUTPUT LV1 | |
| Output LV2 | |
| Output MF. 1/2 | |
| Output flush | |
| Output AUX | |
| Output Alarm | * |
| Output maintenance | * |
| Output OUT | 200 |
| Input Start | |
| Input Stop | |
| Input IN1 | * |
| Input IN2 | * |

Diagnosis (11)

It is possible to request a list of current statuses of the signal inputs and outputs. Active statuses are marked with an *. (see "Structure of the basic program").

The current interface can be checked under the "OUT output". Press the "Enter" key to toggle between minimum and maximum current. 000 and 200 are alternately shown on the display for 0-20 mA!

Time/Date (12)

Set the time and date by selecting and activating the desired function via the arrow keys and the "ENTER" key. Subsequently press the "M" key again to save the setting and to return to the display function.

Refer to "Functions of the operating and display elements" → "Operating system" for more details.

Call the factory default setting:

Press the "M" and "i" key and switch on Titromat® M2.

Caution: All previously entered data is overwritten!

The values and settings of the basic default setting are described in the "structure of the basic program".

Basic program

This menu item can only be accessed after entering the password!

After entering the password and confirming it via the "ENTER" key, it is possible to carry out basic programming of the instrument and to select various service functions (e.g. calibration).

In the basic program, the following abbreviations are used in the respective menu items:

s = seconds; m = minutes; h = hours; T = days; l = litre

Error messages/Troubleshooting

| Displayed message (flashes at selected display) | Instrument result functions | Possible causes | Remedies |
|--|---|--|---|
| Ff. POWER FAILURE 24 V ➤ CANCEL WITH HORN KEY | - After programming: Continuous alarm or message impulses - Standby | - Internal power failure of the 24 V supply | ➤ Replace fuse F4 or F8 (The control lamp "Power" of the dosing pump should illuminate) |
| Ff. DOSING PUMP ➤ CANCEL WITH HORN KEY | - After programming: Continuous alarm or message impulses - Standby | - Dosing pump is defective - No dosing message from the dosing pump | ➤ Replace dosing pump ➤ Check cable to the dosing pump for correct connection |
| Mf. TURBID ➤ CANCEL WITH HORN KEY | - After programming: Continuous alarm or message impulses or no message - Continue measurements | - The water is turbid / soiled | |
| MEASURING RANGE EXCEEDED ➤ CANCEL WITH HORN KEY | - After programming: Continuous alarm or message impulses or no message - Continue measurements | - The measuring range has been exceeded | ➤ Select another type of indicator (basic program) |
| LOW WATER LEVEL ➤ CANCEL WITH HORN KEY | - After programming: Continuous alarm or message impulses or no message - Standby | - No water input although LED "IN" lamp illuminates - Inlet pressure too low - Overflow detection does not react | ➤ Check water inlet ➤ Connector at the inlet valve oxidised ➤ Clean filter strainer ➤ Replace valve block Extract flow controller valve body ➤ Replace fuse F6 |
| Ff. OUTLET TO DRAIN ➤ CANCEL WITH HORN KEY | - After programming: Continuous alarm or message impulses - Standby | - Water remains in the measuring chamber although LED "OUT" illuminates | ➤ Check water outlet ➤ Connector at the outlet valve oxidised ➤ Replace valve block |
| LOW REAGENT LEVEL ➤ CANCEL WITH HORN KEY | - After programming: Continuous alarm or message impulses or no message LED and output "maintenance" on - Continue measurements | - Minimum reagent quantity not reached | ➤ Check reagent level and, if necessary, refill (enter the filling quantity!) |
| Mf. SOILING ➤ CANCEL WITH HORN KEY | - After programming: Continuous alarm or message impulses or no message LED and output "maintenance" on - Continue measurements | - Sight-glass windows are soiled | ➤ Clean sight-glass windows |
| Ff. OPTICS ➤ CANCEL WITH HORN KEY | - After programming: Continuous alarm or message impulses - Standby | - Plug-in circuit board defective - Error at the optical component (transmitter or receiver defective) | ➤ Replace plug-in circuit board ➤ Replace the measuring chamber holder |

Abbreviations: Ff.: = function fault, Mf. = Measuring fault

| Displayed message (flashes at selected display) | Instrument result functions | Possible causes | Remedies |
|--|--|---|---|
| Mf. ANALYSIS ➤ CANCEL WITH HORN KEY | - After programming: Continuous alarm or message impulses - Standby | - Air inside the dosing hoses - Incomplete mixing - Indicator out of date or use of a third-party indicator | ➤ Retighten dosing pump connections ➤ Replace intake insert in the bottle ➤ Replace stirring bar ➤ Replace indicator, only use HEYL Titromat® M2 indicator |
| Ff. DOSING ERROR ➤ CANCEL WITH HORN KEY | - After programming: Continuous alarm or message impulses or no message - LED and output "maintenance" on - Continue measurements | - Dosing accuracy of the dosing pump | ➤ Replacing dosing pump or return it for calibrating |
| MAINTENANCE INTERVAL EXCEEDED BY XXX DAYS ➤ CANCEL WITH HORN KEY | - After programming: Continuous alarm or message impulses or no message - LED and output "maintenance" on - Continue measurements | - Programmed maintenance date reached or exceeded | ➤ Carry out maintenance and subsequently cancel or confirm |
| Abbreviations: Ff.: = function fault, Mf. = Measuring fault | | | |

Further information

| Error | Possible causes | Remedies |
|--|---|--|
| Current interface functions incorrectly | - Incorrect measured value at the output or no power supplied | ➤ Replace fuse F7 ➤ Replace the interface circuit board |
| Unit is not functioning, even though it is switched on No display | - Fuse F9, F5 or F2 (240 V: F1) defective - Power switch defective - Ribbon cable at display circuit board or base circuit board is loose - Error at display circuit board or base circuit board | ➤ Replace fuses ➤ Replace power switch ➤ Reconnect ribbon cable ➤ Replace display or base circuit board |

Tripping of a protective circuit

After a protective circuit (fuse) has been tripped, attempt to eliminate the cause of malfunctioning (e.g. replace a defective valve) before reactivating the protective circuit. Frequent triggering is always due to power overload which, in certain circumstances, may also damage to the instrument.

Malfunctioning/Repairing a defective instrument

The repair of a defective instrument – irrespective of the warranty period – is only possible when the instrument is dismantled and returned to us with a description of the error. Furthermore, please inform us of the indicator type being used and the measured medium. Before you return the instrument for repair work, remove the bottle and ensure that the measuring chamber has been flushed out and is empty.

Maintenance

NOTE

Required maintenance measures

- Regular maintenance is necessary to ensure trouble-free operation of the instrument!

Please regularly carry out the maintenance work described in the following section when

- the programmed maintenance date has been reached (display "maintenance interval exceeded")
- the instrument displays the following error messages:
- "Mf. dirtiness" or "Low Reagent low level"
- the last maintenance was carried out max. 6 months ago

Cleaning measures

- Never use organic solvents to clean the measuring chamber or other plastic parts!
- Please observe the safety regulations when handling cleaning agents!
- If the measuring range of the instrument is exceeded over a longer period of time, a coloured film may form on the sight-glass windows. Use alcohol to remove this sticky film.



CAUTION

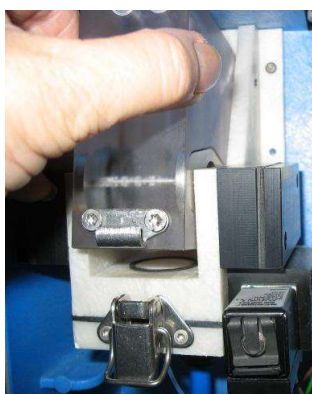

a

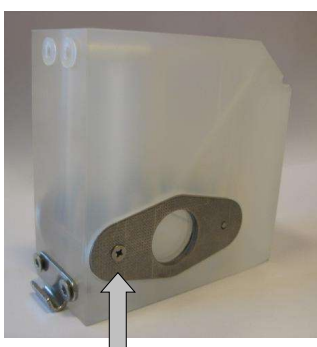

b

Description of maintenance work

The maintenance manual Testomat® 2000/Testomat ECO® contains a detailed description of maintenance work. The measures described here provide a brief overview.

Cleaning the measuring chamber and sight-glass windows

- Switch off the instrument or press the "STANDBY" key. If required, remove any water from the measuring chamber:

M → SERVICE I → MANUAL OPERATION → Drain chamber

- Close the manually-operated valve of the branch line to Titromat® M2.
- Unhook the toggle type fastener a, tip the measuring chamber upwards and remove it.
- Release both sight-glass window holders b, remove and clean the sight-glass windows.
- Use alcohol to clean off the film on the sight-glass windows. If the instrument has been used with hard water for a longer period of time (measuring range exceeded!), a hard-to-remove film may have formed on the sight-glass windows. In this case, clean the sight-glass windows as described below for cleaning the measuring chamber.

- The measuring chamber can be cleaned with a cleaning agent suitable for decalcification and rust removal. Flush the measuring chamber thoroughly after cleaning.
- After cleaning, re-insert the sight-glass windows and secure them with the sight-glass window holders b. (Do not forget the flat seals, making sure they are fitting correctly in the groove).
- Re-insert the measuring chamber and use the toggle type fastener to secure it.

**ATTENTION****Installation of the sight glass windows**

Ensure tension-free mounting of the sight glass windows. Tighten the screws equally alternating both sides. Otherwise, the sight glass windows may break.

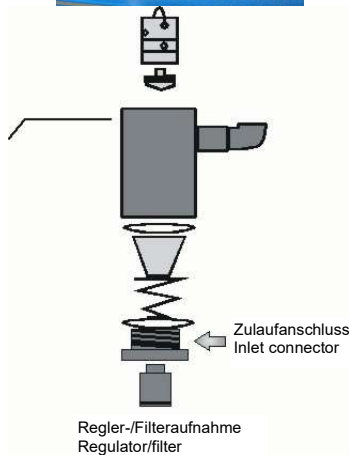
**Cleaning the filter housing**

- Close the manually-operated valve of the branch line to Titromat® M2.
- Depressurise the lines of Titromat® M2 via the "Flush" function:
 -  → SERVICE → MANUAL OPERATION → Flush chamber
- Switch of the instrument and loosen the hose connections at the filter housing.
- Unscrew the inlet connection using an open ended spanner (size 22) and remove the seal, spring and filter.
- Remove the retaining pin and extract the flow controller, subsequently remove the flow controller valve body.
- Clean the filter housing with water or alcohol; then reassemble the unit.
- If required, replace the seals.
- Insert the filter strainer with the cone facing downwards!
- Re-attach the hose connections at the filter housing.

**CAUTION****Important maintenance information**

Water leakage at sealed points can damage parts of the instrument!

Please check the instrument for leaks prior to the first analysis.

- Switch the instrument to STANDBY
- Manually fill the measuring chamber
- Manually dose the indicator ("Manual" key)
- Check the connections and seals for leaks

Service instructions

The surface of the instrument has not been treated. Therefore, soiling caused by indicators, oil or grease should be avoided. However, if the housing becomes soiled, please clean the surface with isopropanol (never use other solvents).

Titromat® M2 spare parts and accessories

| Art. no. | Pressure controller |
|----------------------------------|--|
| 40125 | Controller / Filter receiver, complete |
| 40120 | Controller / Filter receiver |
| 40129 | Controller plug T2000, complete |
| 11225 | Flow controller valve body |
| 11230 | Retaining pin 3x38 |
| 11217 | Inlet filter |
| 11218 | Spring for inlet filter |
| 40121 | Inlet connector |
| 40153 | Screw-in connector G 1/4" -6 |
| 40157 | Angled plug-in connector G 1/8" |
| Measuring chamber | |
| 40173 | Sight-glass window with seal |
| 40170 | Sight-glass window 30x3 |
| 40176 | Sight-glass holder |
| 33253 | Bolt M3x40 |
| 40032 | Latch fastener TL-17-201-52 |
| 11203 | Plastic plug |
| 40022 | Measuring chamber T2000 complete. |
| Measuring chamber holder | |
| 40029 | Measuring chamber holder, complete (without valves) |
| 40050 | Magnetic stirrer |
| 40186 | Screw-in connector 3/8" -10 |
| 40018 | Solenoid valve, 2/2-way |
| 40181 | Rear guide bar for measuring chamber 5x60 |
| Dosing pump DosiClip® | |
| 40001 | Dosing pump SP |
| 40011 | Hose, suction, complete |
| 40016 | Hose, pressure, complete |
| 40040 | Valve set |
| 32046 | Plastic cover CNH 45 N |
| Bottle connection/Suction device | |
| 40131 | Screw cap with bottle insert T2000 |
| 40130 | Screw cap GL32 - hole |
| 40135 | Bottle insert for screw cap with push-fit suction tube |

| Art. no. | Instrument spare parts |
|---|--|
| 31582 | Fuse M4A |
| 40294 | Base circuit board T2000 complete 230 V |
| 40092 | Control circuit board T2000 complete |
| 40091 | Plug-in circuit board driver/receiver SE-T2000 (6) |
| 40190 | Cable gland 5-7 |
| 40191 | Cable gland 7-10 |
| 31713 | Ribbon cable 10 pole with EMI filter clamp |
| 40096 | Ribbon cable 26 pole with EMI filter clamp |
| 40060 | Cable loom 2V complete (for valves) |
| 40062 | Cable loom 2P complete (for max. 2 dosing pumps) |
| 40200 | Cable loom complete with mains switch and cap |
| 31596 | Fuse T0.08A |
| 31585 | Fuse T0.315A |
| 31595 | Fuse T0.1A |
| 31622 | Fuse T0.16A |
| 31592 | Fuse T1.0A |
| Spare parts requirements for 2 - 3 years of operation | |
| 40173 | Sight-glass window with seal |
| 11217 | Inlet filter |
| 40124 | Gasket set T2000 (according to maintenance requirements) |
| 31585 | Fuse T0.315A |
| 31592 | Fuse T1.0A |

Accessories

| Indicator type | Measuring ranges | Art. no. |
|----------------|---------------------------------|----------|
| TC 2020 A | Carbonate hardness 0,05 - 2 °dH | 155170 |
| TC 2020 B | Carbonate hardness 0,05 - 2 °dH | 155171 |

Please refer to our delivery programme for an up-to-date overview of available accessories.

| Art. no. | Description |
|----------|---|
| 040123 | Retrofit kit for water inlet *) |
| 270305 | Current interface card 0/4 - 20 mA, SK 910 |
| 270310 | RS-232 interface card for log printer, RS 910 |
| 270315 | Voltage interface card 0/2 - 10 V, UK 910 |
| 100490 | SD-Card Data Logger for Testomat 2000 |
| 270410 | Booster pump |
| 270337 | Maintenance case T2000 Heyl |

***) Retrofit kit for water inlet (Art. no. 040123)**

If fabric-reinforced pressure hoses (e.g. for existing installations) are used, please replace the plug connector at the controller and filter housing with a plug for the quick-release coupling (not included).

Technical data

| | | |
|-----------------------|--|---|
| Power supply: | 230 VAC, 115 VAC or 24 VAC \pm 10%, 50 - 60 Hz Instrument fuse 230 V: T0,1 A Instrument fuse 115 V: T0,2 A Instrument fuse 24 V: T1,0 A | |
| Power consumption: | max. 30 VA, without external load | |
| Protection class: | I | |
| Degree of protection: | IP 65 | |
| Conformity: | EN 61000-6-2, EN 61000-6-4, EN 61010-1 BS EN 61000-6-4+A1, BS EN 61000-6-2, BS EN 61010-1+A1 |  |
| Ambient temperature: | 10 – 45 °C | |
| Measuring range: | See section "Performance specifications" | |
| Current interface: | 0/4 - 20 mA, max. load 500 Ohms | |
| Dimensions: | W x H x D = 380 x 480 x 280 mm | |
| Weight: | Approx. 9.5 kg | |
| Other: | The instrument is non-volatile | |

| | |
|-------------------------|---|
| Water connection | |
| Operating pressure: | 1 to 8 bar / 1×10^5 to 8×10^5 Pa or 0.3* to 1 bar / 0.3×10^5 to 1×10^5 Pa (Remove flow controller valve body 11225!) |
| Water inlet: | Opaque pressure hose with external diameter 6/4x1 mm |
| Water outlet: | Pressure hose with internal diameter 12 mm |
| Water temperature: | 10 to 40 °C |

* When using Titromat® M2 at a pre-pressure of 0.3 bar, it must be ensured that the flow rate through the measuring chamber is at least 400 ml/min.

We reserve the right to make technical changes without notice in the interest of constantly improving our products!
Our manuals are updated regularly. If you have an older version (see version at the back of the manual) you will find the current manual on our website www.heylanalysis.de on the download page.

Conformity Declaration



EC Conformity Declaration



for the following product

Titromat M2

Microprocessor controlled titration monitor for carbonate hardness

We hereby confirm that the above product conforms to the principal health and safety regulations laid down in the EC Directives 2014/30/EU and 2014/35/EU.

This declaration applies to all units produced in accordance with the attached manufacturing documents which are a constituent part of this declaration.

The product was assessed with reference to the following standards:



EN 61000-6-4: Electromagnetic compatibility, Generic emission standard

EN 61000-6-2: Electromagnetic compatibility, Generic immunity standard

EN 61010-1: Safety requirements for electrical equipment for measurement, control and laboratory use



BS EN 61000-6-4+A1 Electromagnetic compatibility (EMC). Generic standards. Emission standard for industrial environments

BS EN 61000-6-2 Electromagnetic compatibility (EMC). Generic standards. Immunity standard for industrial environments

BS EN 61010-1+A1 Safety requirements for electrical equipment for measurement, control, and laboratory use. General requirements

This declaration is made on behalf of

GEBRÜDER HEYL
Analysentechnik GmbH & Co. KG
 Orleansstraße 75b
 31135 Hildesheim

by

Jörg-Tilman Heyl
 General Manager

Hildesheim, 18/08/2021

Check List Titromat®

Dear customers and service technicians,

This check list cannot replace your expertise or extensive experience in fault resolution. It is intended to support fast and systematic error diagnosis and error documentation. This list does not claim to be complete. We are therefore always grateful for any advice and information you may be able to provide. General user instructions can be found on the rear of this check list.

The Instrument Manufacturer

Block 1 / Plant and instrument data

| | | | | | |
|------------|-----------------|----------------|----------------|-----------------|----------|
| | Testomat 2000® | | | | |
| | Titromat® | | | | |
| Plant type | Instrument type | Instrument no. | Indicator type | Software status | Pump no. |

Block 2 / Error message and error history

Please mark appropriately (X)

| | | | | |
|--|-----|----|--|------------------------|
| What does your instrument's error history display? (“i” and “Enter” key => operating instructions) | | | | (Error history text) |
| Does an error message appear on the display? For example, “Mf. analysis”, “Low water level”, etc. (See operating instructions: “Error messages / Troubleshooting”) | Yes | No | | (Error message text) |

Block 3 / Visual inspection and functional test

Please mark appropriately (X)

If applicable, values / comments

| | | | |
|--|-----|----|-----------------|
| Is the instrument connected to the mains voltage specified on the rating plate? | Yes | No | |
| Does a message appear on the display? | Yes | No | |
| Does the instrument display a plausible measured value? (possible manual measurement _____ value) | Yes | No | Measured value: |
| Are the measuring chamber and sight-glass windows clean? | Yes | No | |
| Are the measuring chamber and the water-carrying hoses free of leaks? | Yes | No | |
| Is the indicator's expiry date still valid? (See expiry date printed on the indicator bottle) | Yes | No | Expiry date: |
| Is the water pressure within the specified range (400 ml/min)? (See the type plate on the instrument) | Yes | No | Plant pressure: |
| Does the drain hose prevent the risk of backwater? (No “syphoning effect”!!) | Yes | No | |
| Is the drain hose free of blockages? (Microorganisms caused by contamination, etc.) | Yes | No | |
| Does the set flushing time/quantity of flush water ensure that only freshwater is measured? | Yes | No | Flushing time: |
| Are the hoses at the dosing pump free from air bubbles? (Operate the pump manually / Carry out a manual analysis) | Yes | No | |

CARRYING OUT A (MANUAL) ANALYSIS

| | | | |
|--|-----|----|------------------------|
| Does the water column rise evenly up to the overflow borehole when filling the measuring chamber (5 mm below the upper edge of the measuring chamber)? (If not: check the water pressure, water throughput/flow controller) | Yes | No | |
| Does the indicator pump dose correctly when starting an analysis? (LED at the pump illuminates!) | Yes | No | No. of dosing strokes: |
| Have the indicator and water been mixed properly in the measuring chamber after the dosing process? Check the magnetic stirring bar! =>see maintenance manual “Adjust mode” | Yes | No | |

PROGRAMMING DATA / OPERATING CONDITIONS

| | | | |
|--|-----|----|---|
| Have the limit values been set correctly? (Within the measuring range/according to the performance limit of the plant?) | Yes | No | Limit values: |
| Is the Titromat instrument always supplied with mains voltage – except during maintenance work/emergency situations? (Temporary shutdown only via the “Standby” key or the “Stop” input!) | Yes | No | See the “General instructions for operating Testomat 2000® and Testomat® ECO” |

Please refer to “Error messages / Troubleshooting” in the **operating instructions** for further information on error messages and possible causes of faults.

Further functional tests (e.g. overflow detection and amplification setting => “Special function Adjust mode”) and service instructions can be found in the **maintenance manual**.

After completing these checks, experience shows that it can be assumed that the checked functions (Block 3) are in effective working order if you have answered all the questions with “Yes”. We recommend you to carry out these checks during each inspection or if faults occur.

Instrument settings

Caution!

Your settings may be deleted if repairs are carried out. Therefore, note down your instrument settings in the table below before sending the instrument to our service team for repairs. Please enclose a copy of the table with the instrument. If you have noted down the settings, they can be easily re-entered by your service staff once any repairs have been completed.

| Menu | Setting |
|----------------------------------|---------|
| MODE OF OPERATION | |
| Time-controlled | |
| Volume interval | |
| External (Start) | |
| DISPLAY UNIT | |
| Display in °dH | |
| Display in °f | |
| Display in ppm CaCO ₃ | |
| Display in mmol/l | |
| LIMIT VALUES | |
| Limit val. 1: | |
| Limit val. 2: | |
| FLUSH TIMES/INTERVAL | |
| Internal flush time | |
| External flush time | |
| Interval pause | |
| MEASURING POINTS | |
| 1 Measuring point | |
| 2 Measuring points internal | |
| 2 Measuring points external | |
| TYPE OF WATER METER | |
| 1 Litre/Impulse | |
| 2,5 Litres/Impulse | |
| 5 Litres/Impulse | |
| 10 Litres/Impulse | |
| 100 Litres/Impulse | |
| 500 Litres/Impulse | |
| 1000 Litres/Impulse | |
| FUNCTION LV1 | |
| Duration | |
| Impulse | |
| Interval | |
| Two point | |
| Time: | |
| FUNCTION LV2 | |
| Duration | |
| Impulse | |
| Interval | |
| Time: | |
| HYSTERESIS LV1 | |
| Analysis (1,2,3) | |
| HYSTERESIS LV2 | |
| Analysis (1,2,3) | |
| ALARM/MESSAGE | |
| Reagent low level | |
| Low water pressure | |
| Mf. analysis | |
| Ff. optics | |
| Ff. dosing fault | |
| Ff. dosing pump | |
| Ff. outlet to drain | |
| Mf. dirtiness | |

| | |
|----------------------------|--|
| power failure 24 V | |
| Mf. turbid | |
| Meas. range exceeded | |
| Maint. int. exceeded | |
| FUNCTION IN1 | |
| Normally open contact | |
| Normally closed contact | |
| FUNCTION STOP | |
| Normally open contact | |
| Normally closed contact | |
| INTERFACES | |
| Type 0-20 mA | |
| Type 4-20 mA | |
| Type RS232 | |
| Type Data logger | |
| FUNCTION AUX | |
| Contact before analysis | |
| Contact during analysis | |
| Contact after analysis | |
| Time: | |
| CALIBRATION | |
| Calibr. value | |
| Calibration | |
| Correction factor | |
| OPERATING TIME | |
| MAINTENANCE INTERV. | |
| CUSTOMER SERVICE | |
| | |
| | |
| | |

Product overview Testomat 2000®-Instruments



| Model/Type | Measuring Parameter | Measuring Range | Applications/Functions |
|--------------------------------------|--|---|---|
| Testomat 2000® | <ul style="list-style-type: none"> • Water hardness • Carbonate hardness • p-value • minus-m-value | 0.05-25 °dH 0,5-20 °dH 1-15 mmol/l 0.05-0.5 mmol/l | <ul style="list-style-type: none"> • Universal for water treatment plants • allowed for boiler houses |
| Testomat 2000® Antox | as Testomat 2000® | as Testomat 2000® | <ul style="list-style-type: none"> • dosing a reducing agent |
| Testomat 2000® CAL | as Testomat 2000® | as Testomat 2000® | <ul style="list-style-type: none"> • Automatic calibration function |
| Testomat 2000® CLF | • Free Chlorine | 0-2.5 mg/l | <ul style="list-style-type: none"> • DPD-method for swimming pool and drinking water control |
| Testomat 2000® CLT | • Total Chlorine | 0-2.5 mg/l | <ul style="list-style-type: none"> • DPD-method for swimming pool and drinking water control |
| Testomat 2000® CrVI | <ul style="list-style-type: none"> • Chromate • Chrome-VI | 0-2.0 mg/l 0-1.0 mg/l | <ul style="list-style-type: none"> • process control of waste water in galvanic industry |
| Testomat 2000® Duo | as Testomat 2000® | as Testomat 2000® | <ul style="list-style-type: none"> • Controlling of two measuring points |
| Testomat 2000® Fe | • Iron-II and Iron-III | 0-1.0 mg/l | <ul style="list-style-type: none"> • De-Ironing plants |
| Testomat 2000® Polymer | • Polyacrylate | 0-50 mg/l | <ul style="list-style-type: none"> • Monitoring of conditioning agents in the cooling and heating cycles |
| Testomat 2000® SO₃ | • Sulphite | 0-20 mg/l | <ul style="list-style-type: none"> • Control of the Oxygen-binding by Sulphite in boiler feed water |
| Testomat 2000® self clean | as Testomat 2000® | as Testomat 2000® | <ul style="list-style-type: none"> • Automatic cleaning of the measuring chamber |
| Testomat 2000 THCL® | <ul style="list-style-type: none"> • Total Chlorine • Water hardness | 0-2.5 mg/l 0.25-2.5 °dH | <ul style="list-style-type: none"> • DPD-method for swimming pool and drinking water control • combination system for hardness and chlorine |
| Testomat 2000® V | <ul style="list-style-type: none"> • Water hardness • Carbonate hardness | 1.0-25.0 °dH 1.0-20.0 °dH | <ul style="list-style-type: none"> • blending water |

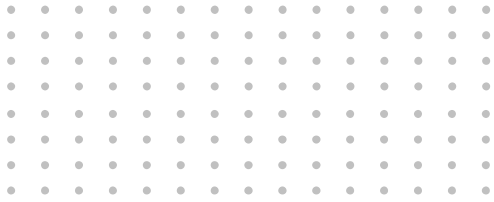

Gebrüder Heyl
Analysentechnik GmbH & Co. KG
Orleansstraße 75b
D 31135 Hildesheim
www.heylandanalysis.de

Titromat M2_EN_210901



Scan the code and
visit us on our website!