

# Softmaster<sup>®</sup> MMP 1

Microprocessor controller for softening plants

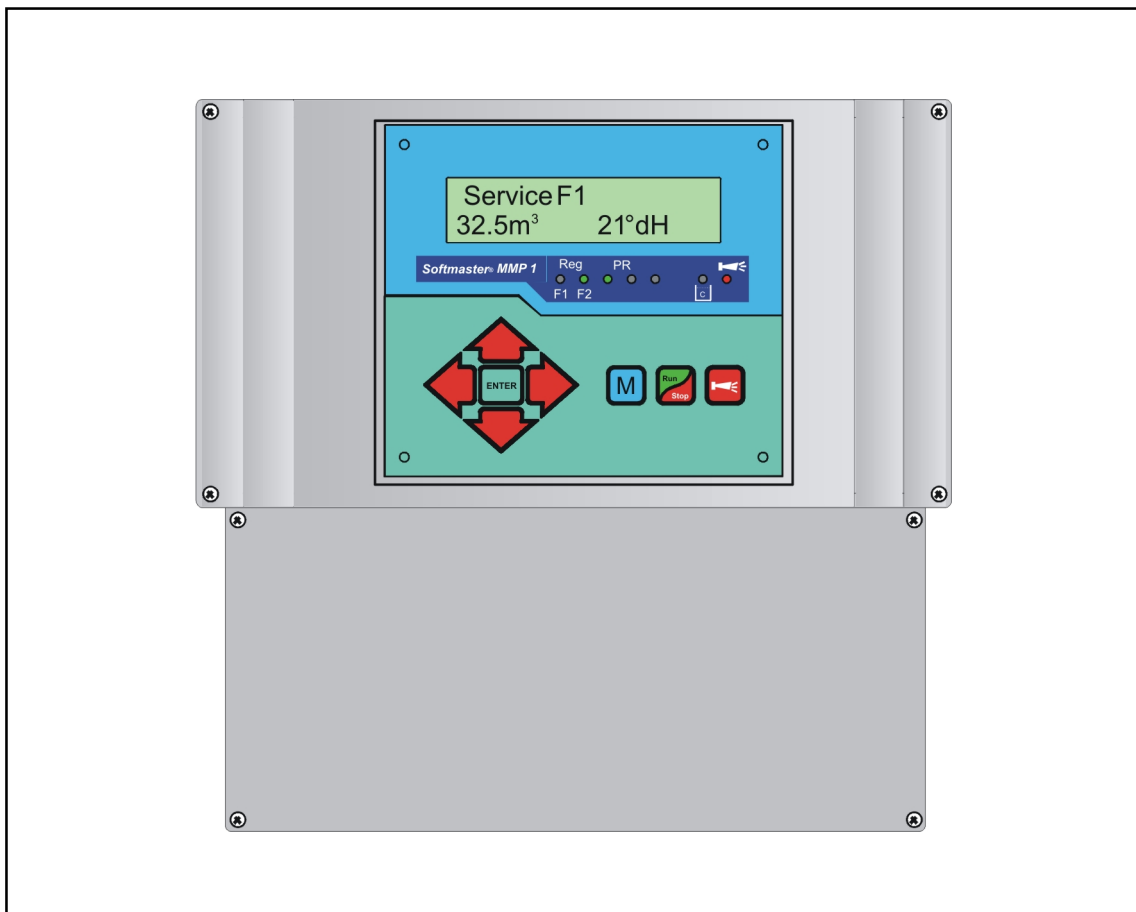

Operating instructions

# Table of Contents

<b>General notes</b> .....	<b>3</b>	Hardness unit.....	16
Introduction.....	3	Exchanger capacity .....	16
Handling notes .....	3	Regeneration .....	16
Safety instructions .....	3	Regeneration delay.....	17
Installation and commissioning .....	3	Early regeneration triggering .....	17
<b>General description</b> .....	<b>4</b>	Regeneration interval.....	18
Views of the instrument.....	4	Regeneration prior to operation .....	18
Description of display and operating features .....	5	Minimum regeneration interval .....	18
Display functions .....	5	Regeneration stages.....	18
Display top line.....	5	Fct. Out AL/PR.....	19
Display bottom line .....	5	Additional program PR.....	19
LED displays .....	6	Water meter .....	19
Operating displays.....	6	Function start input .....	19
Error messages.....	7	Function stop input .....	19
<b>Terminal block identification</b> .....	<b>9</b>	Function prog input .....	20
Functions.....	9	Chemical tank monitoring (LL input).....	20
Description of the relay outputs.....	11	Language .....	20
Filter 1 / Filter 2 .....	11	<b>"SERVICE" menu</b> .....	<b>21</b>
BV .....	11	Regeneration of the reserve filter .....	21
Sync.....	11	Filter change without regeneration start.....	21
AL / PR.....	11	Hardness raw water .....	21
Description of the signal inputs .....	12	Filter capacity .....	21
Start .....	12	Regeneration information .....	21
Stop .....	12	Regeneration meter.....	21
Prog .....	12	Water meter.....	22
LL .....	13	Fast mode.....	22
WM.....	13	Operating hours.....	22
<b>Programming</b> .....	<b>14</b>	Time / Date .....	22
Menu start.....	14	Error history .....	22
Menu selection / Selection .....	14	Status history.....	23
Input .....	14	Diagnosis.....	23
Menu end .....	14	Software status.....	23
Information menu .....	14	<b>Menu structure</b> .....	<b>24</b>
Programming .....	14	<b>Technical Appendix</b> .....	<b>25</b>
Enter password.....	14	Example for a 2-filter softening plant .....	25
Change password .....	14	Connection example .....	26
Switching on and power failure .....	15	Conformity Declaration .....	27
Operating modes (plant type).....	15	Technical data.....	28
Electrical control of the regeneration valves .....	15		

# General notes

## Introduction

These operating instructions describe the installation, operation and programming of the Softmaster MMP 1 controller. We recommend that, while familiarising yourself with the operation of the instrument aided by these operating instructions, you have immediate access to the operable controller in order to perform the described functions and combinations. As certain functions are interrelated, it is advisable to follow the instructions in the given order. Should problems or questions arise while operating the controller which are not described in these operating instructions and/or cannot be solved, our customer service is always at your disposal. Try to identify the problem as accurately as possible and record the actions and conditions under which it occurred. This will enable us to offer you swift effective assistance.

## Handling notes

Quick, repeated switching on/off of the controller should be avoided. Wait at least 5 seconds before switching 'on' or 'off' at the main switch.

Only operate the controller in compliance with the ambient conditions (e.g. temperature, moisture) stated in the Technical Data. Always protect the controller against moisture.

It should never come into contact with condensation or splash water.

The warranty shall not apply if the controller is tampered with, altered, modified or repaired contrary to the instructions described in this manual.

Before dismantling a defect controller, always write down the description of the error (failure effect).

The repair of a defective controller (irrespective of the warranty period) is only possible when the controller is dismantled and returned to us with a description of the error.

The maximum electrical load capacity of the relay outputs and the total power rating of the plant should never be exceeded.

The controller should only be used for its specified intended purpose.

## Safety instructions

Always adhere to the following safety instructions:

The controller must be installed and operated in compliance with relevant standards (e.g. DIN, VDE, UVV) or in accordance with regulations laid down by the respective country.

Some functions (e.g. manual filter change) allow direct manipulation of the plant (valves, pumps, etc.) without locking or monitoring. These functions should only to be used by fully qualified personnel.

If you observe malfunctioning of the controller, switch it off immediately and inform the service personnel.

Do not attempt to repair the controller yourself (loss of warranty rights); instead always contact authorised service personnel. This is the only way to ensure reliable and safe operation of the plant.

After a protective circuit (fuse, motor protection switch) has been triggered, attempt to eliminate the cause of malfunctioning (e.g. clean the pump) before reactivating the protective circuit. Frequent triggering is always due to an error which, in certain circumstances, may also cause damage to the controller.

Non-adherence to these instructions can damage the controller as well as the plant and may result in a loss of warranty rights.

## Installation and commissioning

### Installation and commissioning should only be carried out by authorised technicians!

The connecting cables to the sensors should be kept as short as possible and **clear** of power cables. Close proximity to strong electromagnetic radiators can lead to deviations of the display; in this case, separate interference suppression measures should be carried out.

After installation, program the instrument with the plant-specific features and data (e.g. switch functions, conductivity limit values, etc.). The data is permanently stored (also during power failure).

# General description

## Views of the instrument

Wall-mounted variant

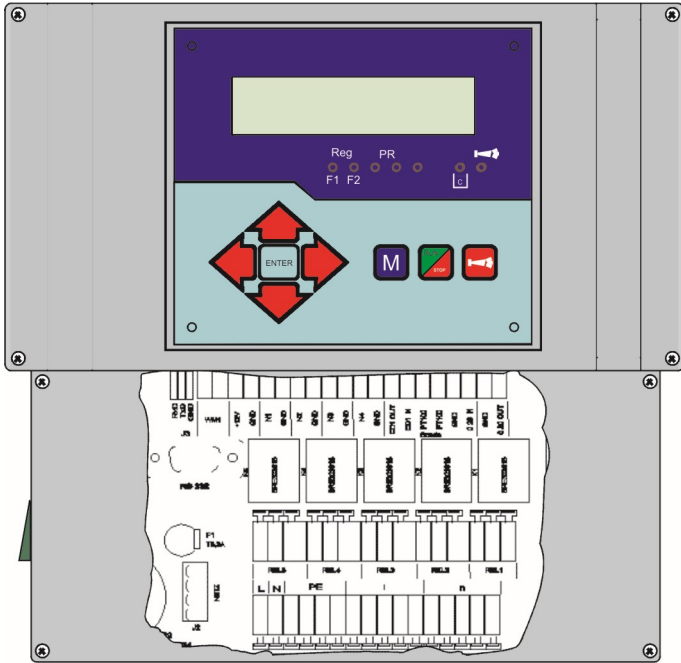

Terminal box

Panel-mounted variant

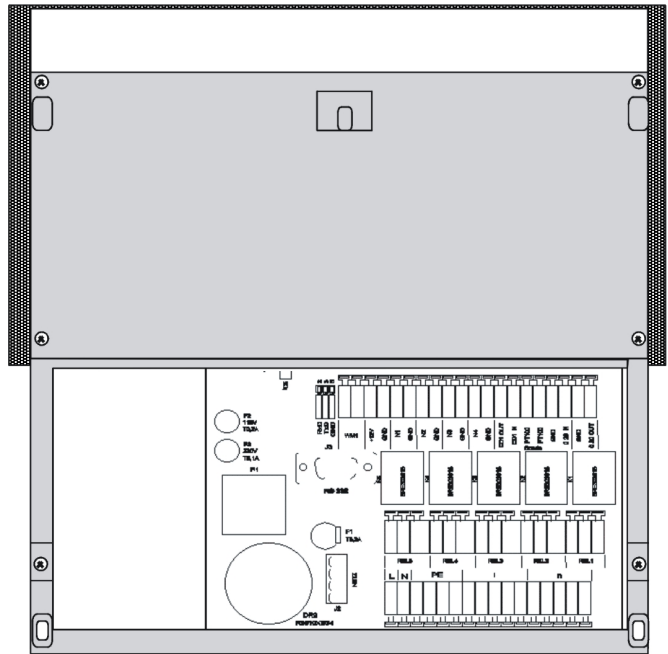

Terminal box

Drilling-scheme for wall-mounted variant

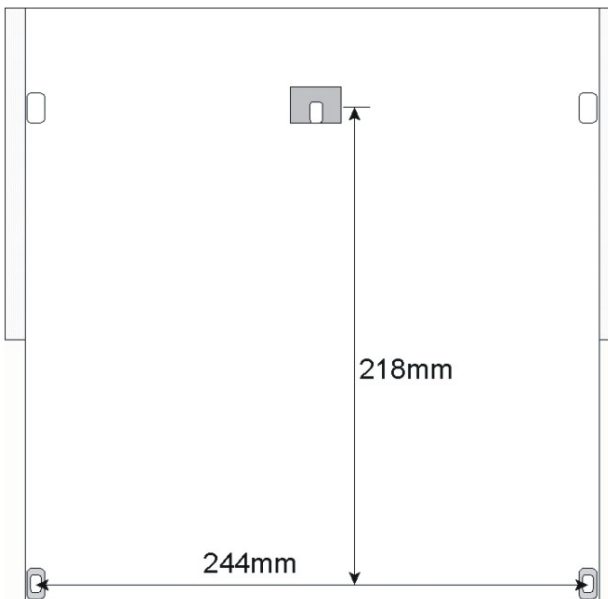

Panel cut-out for panel-mounted variant

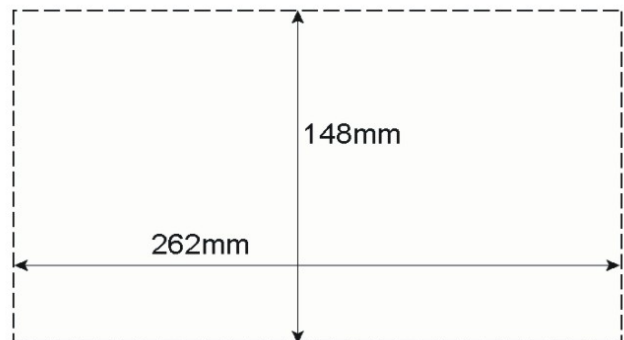

## Description of display and operating features

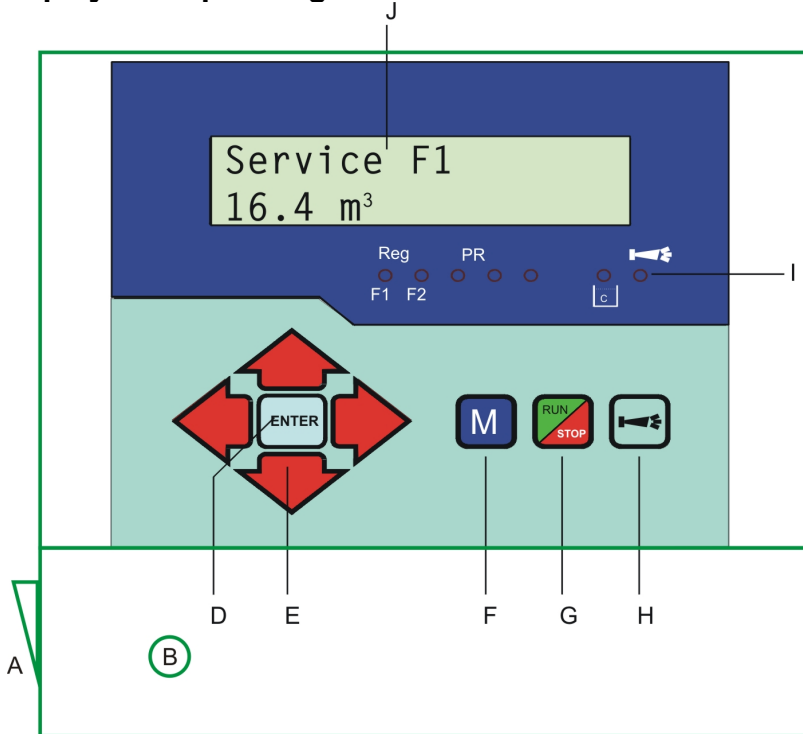

### A On/Off switch

Only the wall-mounted variant is equipped with an On/Off switch on the side. Use this switch to switch the instrument on or off.

### B Fuse, max. T6.3A

The safety fuse protects the outputs against overload or a short circuit. (Inside the instrument)

### D "ENTER" key

Use the ENTER key to confirm inputs and trigger functions.

### E Arrow keys

Use these keys to operate the menu drive in the display and to enter numerical values and programming data.

### F "M" key

Call the menu and return from submenu levels.

## Display functions

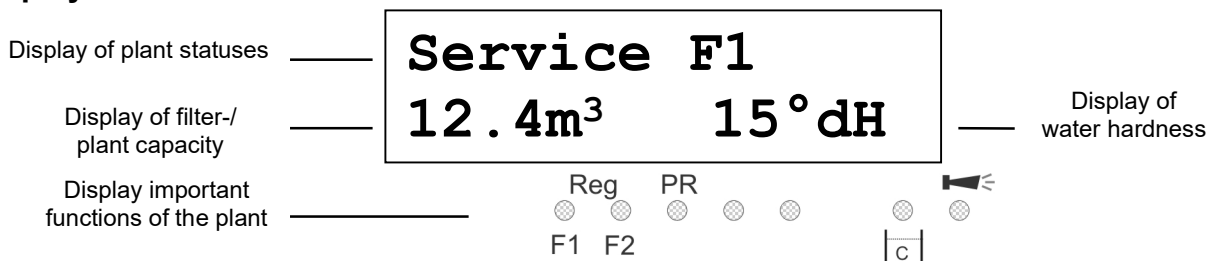

### Display top line

The top line shows operating displays and error messages (described below).

### Display bottom line

The display of the plant or filter residual capacity (still available quantity of soft water) and the raw water hardness (entered manually) occurs in the bottom line.

### Regeneration-Start/Stop")

If the key is pressed for 5 seconds, manual triggering of regeneration occurs (the filter in operation is regenerated) or current regeneration is stopped (depending on the type of plant the filter starts to operate / is put into standby or reserve). Regeneration is restarted from a regeneration stop after pressing the key briefly.

### H "Horn" key (fault OFF)

Deletes the alarm signal at output 'AL' (Alarm), a fault display can only be deleted if the fault has been eliminated.

### I LED functions

LED symbols always signal the status of the plant, irrespective of the level (menu) you are working at.

### J LC display

Two lines, each line with 16 characters, backlit.

## LED displays

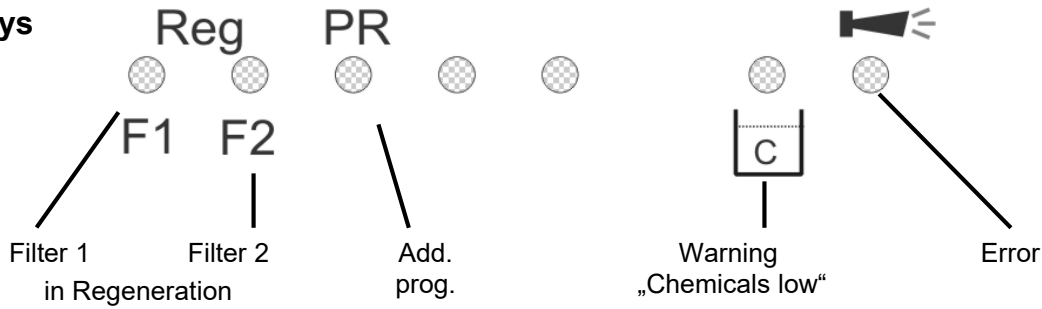

The displays signal operating statuses, plant functions and current error messages:

### Reg. F1 and Reg. F2 (green)

LED lights up: Filter 1 or Filter 2 in regeneration.

LED flashes: Today, a regeneration of the respective filter is triggered at the set time (also see Regeneration delay).

### PR (green)

LED lights up: Additional program active, relay "AL/PR" switched.

### Warning message "Low chemicals" (yellow)

LED lights up: The low chemicals contact is active (also see LL input).

### Error message "Alarm" (red)

LED lights up: Alarm relay has been activated, error message not confirmed yet and error still occurring.

LED flashes: Alarm relay no longer active, error message has been confirmed but the error is still occurring.

As long as an error is still occurring, it is shown alternately with the operating display.

## Operating displays

Each status change is saved in the status history (e.g. manual regeneration, filter change).

Service F1
12.3m <sup>3</sup> 21.4°dH

Filter 1 in operation with 12.3m<sup>3</sup> residual capacity (still available quantity of soft water) and a set raw water hardness of 21.4dH.  
Display only occurs for double-filter plants.

or:

<b>F2 mode</b>	Filter 2 in operation (two filter plant)
<b>Mode</b>	Filter in operation (single filter plant)

Reg F1, R2: 43m
12.3m <sup>3</sup> 21.4°dH

Example: Filter 1 in regeneration: With regeneration stage R2 and remaining stage period of 43 minutes. The LED "Reg. F1" lights up.

or:

**Reg F2, R1: 7m**

Example: Filter 2 in regeneration: With step R1 and remaining stage period of 7 minutes.

PR on: 10m
12.3m <sup>3</sup> 21.4°dH

Additional program PR active prior to regeneration, remaining period 10 minutes.  
The LEDs "Reg. F1" and "PR" light up.

Reg. STOP/Hold
12.3m <sup>3</sup> 21.4°dH

Regeneration stopped via the STOP input or regeneration start delayed.  
Briefly press the "Run/Stop" key to restart regeneration.

## Error messages

In addition to the displayed error messages, the red LED "Alarm" lights up or flashes.  
Alternate display of all error messages and operating displays.  
Each occurred error is stored in the error history.

### Error message "Power failure"

Power failure

Message after each switching on, "power failure". Check the time and, if necessary, set the time.

After switching on or after voltage recovery, the controller starts with the last active status. Current regeneration is continued.

Check the plant for possible negative results due to the power failure (e.g. exhaustion due to excessive washing in the regeneration stage "wash out").

All stored values remain stored even during a power failure.

Confirm the fault display via the "Horn" key.

---

### Error message "Plant override"

Plant override

Regeneration triggered via a contact at the start input or via too high consumption while a filter is still being regenerated.

In multi-filter plants it can occur that a filter is in regeneration and a second filter is also waiting to be regenerated. This status can occur if the soft water consumption is very high, e.g. when filling a swimming pool. If this scenario occurs, the plant will only provide raw water to the consumers. If only soft water should be provided, the soft water supply to the consumers has to be closed.

Wait until the current filter regeneration has finished and then open the soft water supply to the consumers. The controller will always automatically complete regeneration of this filter.

Find and eliminate the fault and confirm the fault display via the "Horn" key.

If regeneration is really necessary again (triggered via consumption measurement), regeneration will occur at the end of the current regeneration.

If you have programmed a minimum regeneration interval, regeneration will be started after this period has expired. With triggering via a contact at the START input, you have to start regeneration manually via the "Run/Stop" key.

---

### Error message "Minimum regeneration interval not achieved"

Min. reg. pause

Regeneration triggering via a contact at the start input or via excess soft water. The required temporal interval to the previous regeneration has not been observed.

Confirm the fault display via the "Horn" key.

Regeneration requested via the water consumption is executed after the programmed period.

Regeneration triggering via the START contact is ignored. Check the plant and trigger a required regeneration manually. The error message is subsequently deleted.

---

### **Error message "Maximum number of regenerations achieved"**

Min. reg. nums.

The entered maximum number of possible regenerations has been achieved. The current status of the regeneration meter can be viewed in the SERVICE menu under "Reg. meter".

In addition to the error message, the yellow warning light "**Low chemicals**" lights up. Confirm the fault display via the "Horn" key. The message remains until the regeneration meter has been deleted. Delete the regeneration meter in the SERVICE menu under "Reg. meter".

---

### **Error message "Low chemicals"**

Chemicals low

The chemical tank is empty. The EMPTY signal is present at the contact input "LL" and the input is programmed as the "Low chemicals" contact.

In addition to the error message, the yellow warning light "**Low chemicals**" lights up. Confirm the fault display via the "Horn" key. Check the chemical tank and the desalination valve or the automatic refilling of the proportion tank. The error display is only deleted after the fault has been eliminated.

---

### **Error message "Regeneration stopped"**

Reg. STOP/Hold

If the program has been stopped via an external switch (STOP input) prior to or during regeneration and if you have programmed the alarm message for the STOP input, the display "Reg. STOP/Hold" will appear as an error message.

Confirm the fault display via the "Horn" key. The display will be deleted as soon as the switch re-opens and the program continues.

---



## Terminal block identification

**Functions** (IN = input, OUT = output)

No.	Terminal	Type	Function	Note
	PE	IN	4x mains protective earth	
	L N	IN	Mains, N = Neutral Mains, L = Live	Mains input 230 - 240 V AC
	l n	OUT	5x live, switched 5x Neutral, switched	Mains voltage, max. 6 A
1 2 3	Filter1	OUT	Filter 1 - normally open Filter 1 - common Filter 1 - normally closed	Volt-free relay output max. Load 240 V AC, 6 A
4 5 6	Filter2	OUT	Filter 1 - normally open Filter 1 - common Filter 1 - normally closed	Volt-free relay output max. Load 240 V AC, 6 A
7 8 9	Sync	OUT	Flush valve - normally open Flush valve - common Flush valve - normally closed	Volt-free relay output max. Load 240 V AC, 6 A
10 11 12	BV	OUT	Operating valve - normally open Operating valve - common Operating valve - normally closed	Volt-free relay output max. Load 240 V AC, 6 A
13 14 15	AL/PR	OUT	Fault message output - Add. prog. normally open Fault message output - Add. prog. common Fault message output - Add. prog. Normally closed	Volt-free relay output max. Load 240 V AC, 6 A
16 17	WM 2	IN	Water meter Common earth for inputs	Only connect volt-free normally open / closed
18 19	+12V 2	OUT	12V-Supply for turbine Common earth for inputs	See water meter description!
20 21	LL 2	IN	Storage tank EMPTY Common earth for inputs	Only connect volt-free normally open / closed
22 23	Prog 2	IN	Add. program Start Common earth for inputs	Only connect volt-free normally open / closed
24 25	Stop 2	IN	Stop plant Common earth for inputs	Only connect volt-free normally open / closed
26 27	Start 2	IN	Start plant Common earth for inputs	Only connect volt-free normally open / closed
28 29	-	-	-	-
30 31	-	-	-	-
32 33	-	-	-	-
34 35	-	-	-	-

**Terminal blocks for mains supply and relay outputs**

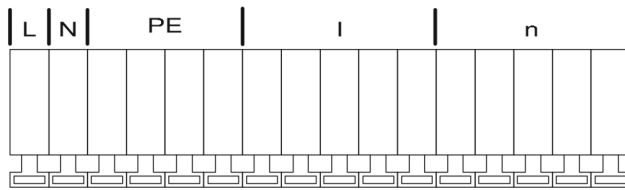
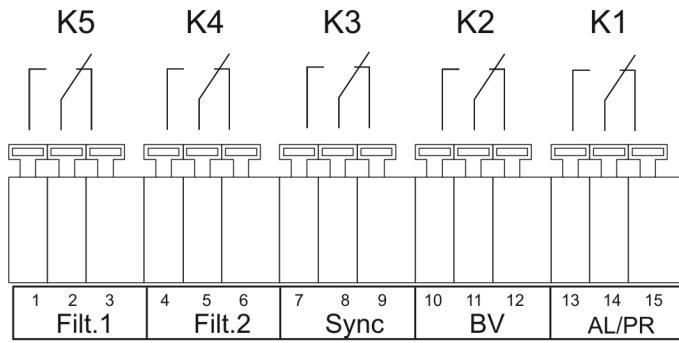

**Terminal block for inputs and interface**

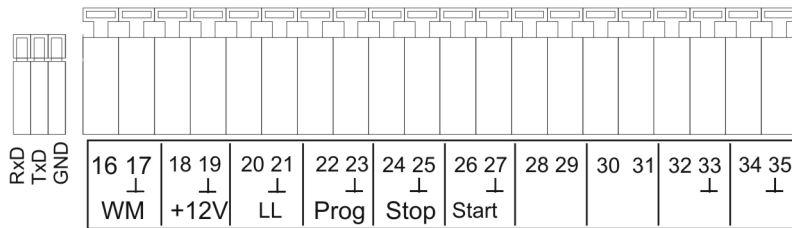

## Description of the relay outputs

### Filter 1 / Filter 2 Pilot distributor or central control valves 1 and 2

Connect the regeneration valves (central control valves) or pilot distributors which are controlled via an electrical change-over switch or impulse switch control at these relay outputs.

Change-over contact: For versions with a change-over switch the output changes after each regeneration stage.

Impulse: For versions with an impulse switch control the output switches for 40 seconds (terminal 7 or 7').

The idle position of the relay is the same for de-energized controllers and in the operating position of the filter: Contact at terminal 6 or 6'.

The control version can be set under the menu item

"M" → BASIC PROGRAM → Valve type

### BV Operating valves Filter 1 and 2

The operating valves of the filters have to be designed as normally closed.

### Sync Synchronous contact / Regeneration message

(previously: 8-fold contact for MMP70 / 81)

After power failure (e.g. during regeneration) or with faults, it is usually necessary to synchronise the valves or pilot distributors with the controller. For regeneration valves / pilot distributors with a change-over controller and an uneven number of (electrical) regeneration positions it is necessary to connect these to the synchronous contact. This ensures that the regeneration valve / the pilot distributor returns to the operating position after regeneration. The connection occurs at terminal Sync – 8.

The connection "Sync" can be used to externally display the program course (regeneration) or to control a relay or solenoid valve during regeneration.

### AL / PR Alarm or additional program

The volt-free output "AL/PR" can be used for various functions:

#### as additional program PR

The additional program is used, e.g., for automatic filling of the chemical tank or for controlling an additional valve prior to, during or after regeneration with programmable on-time. If the output "AL/PR" has been switched, the LED "PR" will light up.

Program the function under the menu item (see basic programming "Aux Prog.):

"M" → BASIC PROGRAM → Aux Prog.

#### as fault message output ("Alarm")

The "AL/PR" output is a volt-free change-over relay contact. During trouble-free operation the contact between the terminals 13 – 14 is closed and the one between terminals 14 -15 is open. In case of power failure or a fault, the contact between the terminals 14 – 15 is closed and the one between terminals 13– 14 is open.

The controller monitors a whole range of plant statuses. The "AL/PR" output remains active (terminals 14 - 15 closed) until the fault has been eliminated and confirmed.

The red LED "Error message" and the text on the display indicate a fault.

The fault message signal at the "AL/PR" output is deleted by confirming the fault via the "Horn" key.

The fault display can only be deleted if the fault has been eliminated.

The following faults activate the "AL/PR" output and are displayed if the softening plant or valves/pilot distributor have been equipped with the respective contacts:

The following statuses **always** trigger a fault message:

Power failure

Plant overrun (regeneration start while a filter is still being regenerated)

Occurring error messages depending on the programming:

Minimum regeneration interval

Maximum number of regenerations achieved (the max. regeneration meter level has been reached)

Regeneration stopped via the stop input

When an LL input is used:

Low chemicals

## Description of the signal inputs

### Note

Only connect the signal inputs "WM", "LL", "Prog", "Start" and "Stop" to **volt-free** contacts!

### Start External regeneration start

Connection for hardness monitoring instrument (e.g. Testomat)

Function	Type of Contact	Test time	Action
<b>Start</b> Start of regeneration after exhaustion of the filter programmable	programmable normally closed/ normally open	programmable 1 - 99 seconds	<ul style="list-style-type: none"><li>- Filter change (only for double-filter operation)</li><li>- Regeneration start</li></ul>

To prevent hard water (e.g. due to insufficient regeneration) being removed from the plant, install a hardness monitoring instrument on the output /soft water side.

If a limit value is exceeded (the Testomat limit value contact switches), the filter in the reserve / standby position is put into operation after a programmable test time and the exhausted filter is regenerated.

"M" → Basic program → Funct. Start

### Stop External regeneration interruption / prevention

Connection for volt-free contact

Function	Type of Contact	Test time	Action
<b>Stop</b> Regeneration stop	programmable normally closed/ normally open	programmable 1 - 99 seconds	Regeneration interruption or prevention of a pending regeneration

During regeneration it may be necessary to interrupt the process externally via a switch (e.g. pressure switch in the input). A current regeneration can be stopped via a contact at the STOP input or a pending regeneration can be delayed. The following message is displayed: "Reg. STOP/Hold".

"M" → Basic program → Funct. Stop

### Prog External start of the additional program

Connection for volt-free contact

Function	Type of Contact	Test time	Action
<b>Prog</b> Start of the additional program	programmable normally closed/ normally open	programmable 1 - 99 seconds	External start of the additional program

"M" → Basic program → Funct. Prog

## LL Low chemicals

For extended control of the plant it is possible to use the "LL" input for connecting a level transmitter (monitoring of the chemical tank).

Function	Type of Contact	Test time	Action
<b>LL</b> Level transmitter input: "Low chemicals" alarm or "EMPTY" chemical level	programmable normally closed/ normally open	programmable 1 - 99 seconds	programmable: – Chemical fill valve open – Continuous alarm – Entry in the error list

"M" → Basic program → Funct. LL

## WM Water meter

Use the "WM" input for connecting a water meter.

Function	Type of Contact	Test time	Action
<b>WM</b> Connection for monitoring the water quantity via water meter	programmable normally closed/ normally open	programmable 1 - 99 seconds	programmable: – Quantity of used soft water

"M" → Basic program → Water meter

# Programming

## Menu start

Use the "M" key to open the menu.

## Menu selection / Selection

The current line position is displayed as a header in CAPITAL LETTERS. Use the "ENTER" key to activate the selected/displayed menu item, i.e. you "jump" into a submenu. The next menu item is called via the "DOWN" arrow key: You can "scroll" the menu.

## Input

Inputs are only possible in the **BASIC PROGRAM** menu and in certain **SERVICE** menu items.

Select a programming step via the arrow keys "DOWN" and "UP" and activate the input function by pressing the "ENTER" key.

The first digit/position to be changed flashes when entering digits.

Use the arrow keys "Right" and "Left" to change to the next or previous digit (now flashing).

Use the arrow keys "DOWN" and "UP" to change the value or the selection.

With selection options, selected functions are labelled with a .

Exit the input function via the "ENTER" key.

Use the "M" key to go to the superordinate menu.

"M"

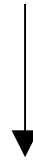

MENU
Service
Information
Basic program

## Menu end

Use the "M" key to jump to the superordinate menu. After returning from the highest menu level, the instrument is in display mode again.

## Information menu

"M" → Information

In the information menu it is possible to request the current settings without entering a password. The information menu is still displayed even if an incorrect password has been entered.

## Programming

"M" → Basic program

## Enter password

The programming menu is protected by a 3-digit password (number between 000 and 999) in order to prevent unauthorised access to the programming.

Enter the password under "M" → Basic program → Password input and confirm the entry via the "ENTER" key.

You are now in the **BASIC PROGRAM** menu.

BASIC PROGRAM
Password input
Change password

If an incorrect password is entered, the INFORMATION menu is opened.

(Password RESET occurs by switching on via the "M" key and the "Right" key. Only for internal use.)

## Change password

Enter or change your individual password at any time. To achieve this, enter the old password (OLD: ) and then the new one (NEW: ).

# Function and programming description

## Switching on and power failure

After switching on the instrument and after each power failure, the plant automatically returns to the last active position.

## Operating modes (plant type)

The Softmaster MMP1 controller can control the following softening plants:

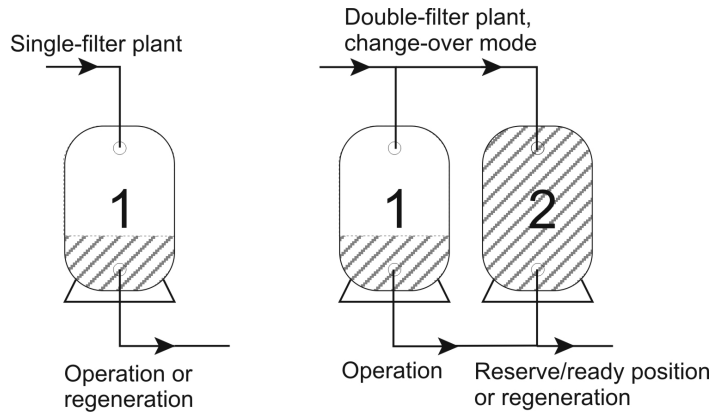

### Single-filter plant

Only one filter is in operation. Soft water is not available during regeneration.

Programming: "Single-filter ✓"

### Two-filter operation

One filter is in operation and the other filter is in the reserve/standby position or is being regenerated. Soft water is usually always available.

Programming: "2-F.change ✓"

OPERATING MODE	
Single-filter	-
2-F.change	✓

## Electrical control of the regeneration valves

You can use control valves or pilot distributors with up to 8 stages / positions with impulse or change-over control.

VALVE TYPE	
Change-over	✓
Impulse	

Examples for 4-stage valves/pilot distributors:  
as change-over contact

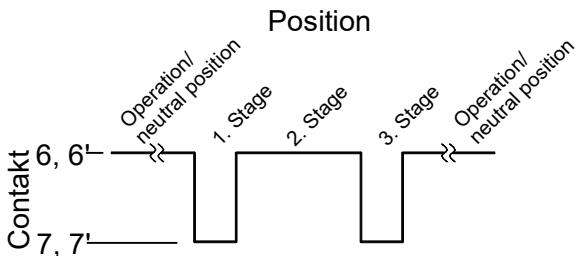

For versions with a change-over switch the output changes after each regeneration stage. With an odd number of the mechanical positions, operating position

reset has to occur via the synchronous contact (operating switch) as impulse

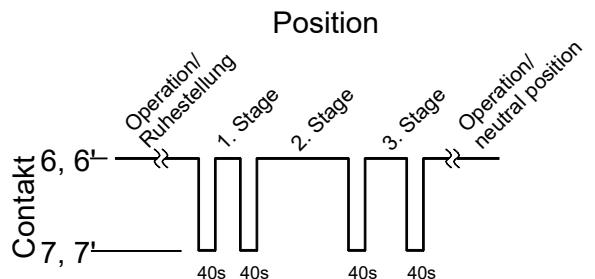

For versions with an impulse switch control, the output switches for 40 seconds at the beginning of each stage (terminal 7 or 7').

## Hardness unit

The raw water hardness can be entered and displayed in various units:

**German hardness = dH**

**French hardness = f (1.79 = 1° dH)**

**ppm as CaCO<sub>3</sub> = ppmCaCO<sub>3</sub> (17.9 ppmCaCO<sub>3</sub>, 1° dH)**

The **exchanger capacity** has to be entered (in the next menu item) according to the unit.

HARDNESS UNIT	
°dH	✓
°f	
ppmCaCO <sub>3</sub>	

## Exchanger capacity

The filter capacity in a m<sup>3</sup> available soft water quantity is calculated by the controller. You enter the **exchanger capacity** of a filter in m<sup>3</sup>x°dH, m<sup>3</sup>x°f or gCaCO<sub>3</sub> and the current raw water hardness (in the "Service" menu).

EXCHANGE CAP.	
m <sup>3</sup> °dH	100

## Calculation of the filter capacity

The filter capacity (also known as the filter performance), i.e. the available soft water quantity, is calculated on the basis of the entered raw water hardness.

"M" → Service → Hardness raw water → Input: 016°dH (example)

The filter capacity remains constant:  $\text{Filter performance} = \frac{\text{Exchanger capacity}}{\text{Raw water hardness}}$  (in m<sup>3</sup>)

The total filter capacity (available soft water quantity after regeneration) can be requested in the service menu:

"M" → Service → Filter capacity

The remaining residual filter capacity or residual soft water quantity is displayed in the operating display.

## Regeneration

### Regeneration start

The regeneration of an exhausted filter can be started via various triggering criteria:

- Manually by pressing the "Run/Stop" key (press the key for 5 seconds)
- After removal of the set soft water quantity (filter capacity)
- After end of the set daily interval for the programmed time
- Via start impulse from the water hardness measuring instrument (Testomat)

### Manual regeneration

A filter change occurs with a manual regeneration start. The filter in operation is regenerated and the filter in the reserve / standby position is put into operation (only for double-filter operation).

### Quantity-dependent regeneration

In most cases it is recommended to record the removed soft water quantity and to regenerate the filter when the calculated filter capacity has been achieved. The filter capacity is calculated by the controller using the programmed exchanger capacity (m<sup>3</sup> x °dH) and the raw water hardness. The quantity recording occurs via a water meter in the filter / plant output.

If you wish to prevent regeneration at an inappropriate time during operation, program **regeneration delay**. Required regeneration is not started until the set time, e.g. 8 pm (see "Regeneration delay"), has been reached.

During change-over mode, the instrument immediately switches to the filter in the reserve position and regeneration of the exhausted filter is carried out at the set time.

Delayed regeneration can result in the overrun of the filter. This can be prevented by selecting **early regeneration triggering** (Reg. start for x% filter residual capacity).

### Time-dependent regeneration

If the plant is to be regenerated in a time-controlled manner, program the daily interval and the time of regeneration (**regeneration delay = ON**).



### Quality-controlled regeneration

With the internal control function combined with a water hardness measuring instrument (e.g. Testomat 2000 / ECO) it is possible to install a convenient and reliable plant. The water hardness measuring instrument monitors the soft water hardness and sends a start signal to the controller to trigger regeneration once the set limit value has been reached. By combining the various control possibilities you can ensure the largest possible operational reliability.

### Stopping or delaying the regeneration

You can cancel a current regeneration manually at any time via the "Run / Stop" key. A regeneration can be delayed or a current regeneration stopped via a contact at the STOP input.

### Regeneration stages

You can program up to 8 regeneration stages. The minimum time per stage is 0 or 1 minute (1 minute: operating time of the valve / pilot distributor), the maximum time is 99 minutes (250 minutes for stage 1).

### Regeneration delay

If a triggered regeneration (e.g. by reaching the filter capacity, time interval or measured hardness irruption) should be carried out at a later date or only within a time window, program regeneration delay ON and the corresponding times.

Regeneration is then only started at the set start time "Reg. at: ", e.g. 8 p.m.. Enter the latest time for the regeneration start under "Reg. to: ", e.g. 6 a.m..

This prevents regeneration from being carried out at an inappropriate time during operation.

REG. DELAY	
On	-
Reg. at:	18:00
Reg. to:	08:00
SV on (1-F)	✓

During change-over mode, the instrument immediately switches to the filter in the reserve position and regeneration of the exhausted filter is carried out at the set time.

For single-filter plants it is possible to specify whether the operating valve should remain open until regeneration or be closed immediately: "SV on (1-F) ✓" = operating valve is only closed at regeneration start.

### Note

Delayed regeneration can result in the overrun of the filter. This can be prevented by selecting **early regeneration triggering** (Reg. start for x% residual filter capacity).

Example for double filter:

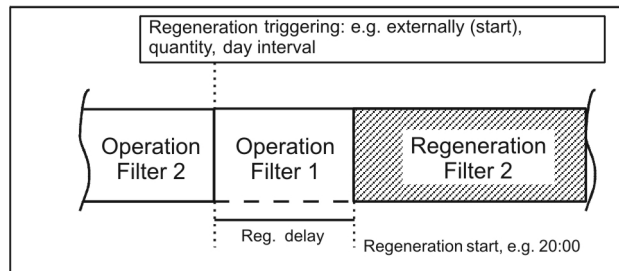

### Early regeneration triggering

Select this function for single-filter plants to ensure a certain soft water consumption for the next day. If regeneration should not be started immediately after the set residual filter capacity has been reached, please additionally program "Regeneration delay" with the desired time for regeneration start. This prevents regeneration from being carried out at an inappropriate time during operation.

REG. PRE-TRIG.	
Resid. cap.	0%

A further application possibility arises when combining "Regeneration prior to commissioning" for double-filter plants. It is possible to set values between 0 and 50% of soft water reserve for early regeneration triggering. (Default setting is 0% = **no** early regeneration triggering)

## Regeneration interval

To prevent improper bacterial contamination of the resin bed during longer downtimes, regeneration can be carried out at fixed daily intervals.

The regeneration interval (0 - 99 days) complies to the operational conditions and national regulations for the drinking water supply (e.g. DVGW, DIN, etc.).

If regeneration should be carried out at a certain time, please additionally program "Regeneration delay" with the desired time for regeneration start.

**Without** regeneration delay the filter will be regenerated at the same time as the last regeneration.

REG. INTERVAL	
Days	0

The interval restarts after each completed regeneration.

In how many days the next interval regeneration will be carried out can be requested in the menu under "M" → Service → Reg. Info → Interv. days

On the day of the interval triggering of a regeneration the control lamp "REG" of the corresponding filter starts flashing at midnight.

## Regeneration prior to operation

Select this triggering type for double-filter plants where bacterial contamination problems can occur due to longer downtimes of the filter in reserve.

To ensure that soft water is still available during the regeneration time, regeneration should be triggered early enough via "early regeneration triggering" so that soft water can still be removed for approx. 2 hours.

REG. BEFORE SERV.	
ON	-

### Notes

It is **not** possible to combine this operating mode with the additional program prior to regeneration with immediate filter change.

The manual service functions "Regeneration of the reserve filter" and "Filter change without regeneration" are also not possible in this operating mode.

## Minimum regeneration interval

If the softening plant is equipped with a desalination tank for chemical storage, the interval between two regenerations has to be at least 4 hours to ensure sufficient chemical concentration. Otherwise regeneration is insufficient and the plant is soon "overrun".

MIN. REG. PAUSE	
	60min

If regeneration can be triggered by an analysis instrument (e.g. Testomat) due to hardness irruption, it is possible to prevent frequent regenerating due to early triggering (e.g. due to hardness increase caused by counter ion effect, or insufficient wash out of the filter, or possible malfunctioning of the measuring instrument) by selecting a minimum regeneration interval.

If regeneration triggering (e.g. by reaching the max. removal quantity or externally via an analysis instrument) occurs within this time, the error message "Min. reg. interval" is displayed and the alarm relay switches. Regeneration has to be triggered manually.

## Regeneration stages

Enter the number of regeneration stages (without operating position!) and the time of the individual stages according to the used central control valves or pilot distributors.

You can program up to 8 regeneration stages / positions.

Choose the time for stage 1: 1 - 250 minutes, stage 2: 1 - 99 minutes, stage 3: 1 - 99 minutes and the other stages: 0 - 99 minutes.

Example:	Valve position	Time (duration)
	Operation	-
	Rerinse	5 Minuten
	Salting and Wash slowly	60 Minuten
	Wash out / Wash quickly	10 Minuten

REG. STAGES	
Max. stages	3
Stage 1	5min
Stage 2	60min
Stage 3	10min
Stage 4	0min
Stage 5	0min
Stage 6	0min
Stage 7	0min
Stage 8	0min

## Fct. Out AL/PR

The output "AL/PR" can either be used as alarm output or as output for the additional program PR.

FCT.OUT AL/PR	
Aux. prog. PR	
Alarm AL	✓

## Additional program PR

With the additional program it is possible to switch on a valve or pump prior to, during or after regeneration **only once** for a programmed time. The additional program can be started internally or externally.

Activate the external start via "Start Prog ✓"

Activate the internal start via "Start reg. ✓".

Enter the triggering time of the additional program under "Start stage:":

**0 =** Prior to regeneration, after exhaustion of the filter capacity. Filter change (switch-over of the operating valves) or regeneration start with **Regeneration prior to commissioning** only occurs after the end of the additional program.

If the switch-over of the operating valves = Filter change FW (or closing of the SV with single-filter plants) should occur immediately after exhaustion of the filter capacity, program "SV off (only 0) ✓". Start of the regeneration process occurs after the end of the additional program. **Not possible with regeneration prior to commissioning !**

**1 to 8:** At the start of the entered regeneration stage 1 to 8, cannot be more than the number of reg. stages.

**2 to 9:** After completion of the last regeneration stage, cannot be more than the number of reg. stages + 1.

Program for how long the relay is to be switched under "Duration: 10min".

If the output "AL/PR" has been switched, the LED "PR" will light up.

AUX PROG.	
Start Prog	-
Start reg.	✓
Start stage:	1
Duration	0min
SV off (only 0)	-

## Water meter

The water meter is used for recording the used soft water quantity. The memory of the water meter is deleted after each regeneration.

Set the impulse numbers for contact water meters or turbines in the menu:

Request the recorded quantity in the "Service" menu, e.g.:

"M" → Service → Water meter → total: 43 m<sup>3</sup>

WATER METER	
L/imp.	100.000

## Function start input

If regeneration should be triggered quality-dependently, a water hardness measuring instrument has to monitor the soft water hardness. If the set limit value has been reached, the measuring instrument sends a start signal to the controller for triggering regeneration.

With two-filter plants a filter change (only serial or double-filter operation) occurs and regeneration is started according to the programming (e.g. regeneration delay).

"M" → Basic program → Funct. Start

FUNCT. START	
norm. closed	-
norm. open	✓
Delay	15s

## Function stop input

During regeneration it may be necessary to interrupt the process externally via a switch (e.g. pressure switch in the input). A current regeneration can be stopped via a contact at the STOP input or a pending regeneration can be delayed.

FUNCT. STOP	
norm. closed	-
norm. open	✓
Delay	5s
Funct. alarm	-

## Function prog input

The additional program can be externally started with this input.

"M" → Basic program → Funct. Prog

FUNCT. PROG	
norm. closed	-
norm. open	✓
Delay	3s

## Chemical tank monitoring (LL input)

The input "LL" has been designed as level transmitter input for the "Low chemicals" alarm or "EMPTY" level.

Program the desired effect of the contact, test time (delay) and alarm function. If you monitor the desalination tank for low chemicals, the input is queried at regeneration start. If the input is active = "Low chemicals" alarm, **no** regeneration is triggered. You have to trigger regeneration manually and confirm the error message.

FUNCT. LL	
norm. closed	-
norm. open	✓
Delay	3s

If the input "Delay" is active after the test time in case of automatic filling of the chemical tank (also see additional program PR), the output "PR" switches. With simultaneous "Low chemicals" monitoring a "Low chemicals" alarm message (e.g. the tank is still EMPTY although the fill valve is open) occurs after the test time of the input.

## Language

Selection of the desired display language:

Six "standard" languages are currently available. If desired other language versions are also possible.

LANGUAGE	
German	✓
English	
French	
Italian	
Polish	
Dutch	

## "SERVICE" menu

Request and change current settings and statuses of the instrument in the service menu.

### Regeneration of the reserve filter

If the reserve/standby filter should be regenerated, press the "ENTER" key in the menu. No filter change occurs.

**This function is only possible with double-filter operation!**

REG. RES. FILTER
START (Enter)

### Filter change without regeneration start

Press the "ENTER" key in this menu to change the current filter.

**This function is only possible with change-over mode!**

ONLY FILT.CHANGE
START (Enter)

### Caution!

The display and memory value of the residual soft water quantity are maintained after each filter change.

### Hardness raw water

Enter the current raw water hardness here.

HARDN.RAW WATER
Setting: 20.0°dH

### Filter capacity

The calculated total filter capacity is displayed.

FILTER CAPACITY
total 5,0m <sup>3</sup>

### Regeneration information

#### Interval days

Display of the days until the next interval triggering.

REG. INFO
Interv.days 0
Chem.supply

#### Chemical storage

Display of the still possible number of regenerations until the chemical storage is exhausted.

Enter the number of regenerations possible with the chemical storage in the "Reg. Counter" menu. If the chemical storage has been exhausted, the "**Low chemicals**" LED lights up.

### Regeneration meter

The controller is equipped with a regeneration meter for monitoring the chemical storage, e.g. salt. Enter the number of regenerations possible with the chemical storage.

REG. COUNTER
Max.number 0
Numbers 0

If the value 00 is entered for the presetting of the meter, the regeneration meter is switched off and no monitoring occurs.

If the set number of regenerations has been reached (= exhausted chemical storage), the "**Low chemicals**" LED lights up.

The number of regenerations which can still be carried out with the available salt quantity is displayed in the "Reg. Info – Chem.supply" menu. After each regeneration the value is automatically reduced by 1. If the value "0" is reached, the error message "Max. reg." is displayed and the fault display "Alarm" flashes. Confirm the alarm by pressing the "Horn" key.

### Reset

After chemicals have been refilled up to the specified filling height, the regeneration meter is reset to the initial value by pressing "Reset (ENTER)" in this menu.

### Early reset

If the chemical storage tank is, e.g., still half full with chemicals and you still wish to refill it up to the specified filling level, you have to reset the regeneration meter to the initial value via "Reset (ENTER)" in this menu.

### Caution!

A regeneration process is also not stopped in case of the message "Max. reg." (low chemicals).

## Water meter

The water meter records the removed soft water quantity for the quantity-dependent regeneration triggering and the total quantity counted since the last reset. Reset (ENTER): Resets of the currently stored total soft water quantity.

WATER METER	
Soft water	0.0m <sup>3</sup>
Total	0.0m <sup>3</sup>

## Fast mode

**The fast mode can only be started during regeneration!**

**If regeneration has been started manually, you have to wait for 1 minute before switching on the fast mode! In this time the function is locked, the waiting time is displayed: "Please wait ...s !"**

QUICK MOTION
Start reg. !

Press the "ENTER" key to start the regeneration fast mode. The programmed time of the regeneration stage is passed through every second. After the end of the regeneration stage started with fast mode, the controller returns to normal mode. Press "ENTER" again to pass through the next stage in fast mode.

## Operating hours

The instrument records operating hours of the plant/controller and thus the load of the filter.

The current operating time can be requested in the service menu:

"M" → Service → Operating time

OPERATING TIME
0 h

### Resetting the operating hour meter:

After replacing the resin bed or filter, it is possible to reset the current operating time to 0 hours:

"M" → Service → Operating time → Reset

## Time / Date

Please observe that the installed clock only continues to run when the instrument is switched on.

After a longer period of power failure or if the plant was switched off, the time and date should, if necessary, be corrected.

**Display:** "M" → Service → Time Date

The date and time of the controller are shown in the display.

TIME	DATE
00:00	01.01.01

**Setting:** Press the "ENTER" key under menu "M" → Service → Time Date

Set the time and date by selecting the desired position via the arrow keys "Right" and "Left" and changing them via the arrow keys "UP" and "DOWN". Subsequently press the "ENTER" key again to save the setting and to return to the display function.

## Error history

Open the error history via "show". The error history is a list of errors which have occurred during current operation.

The occurred error is recorded with error number, time and date, e.g.:

Low chemical            6  
06:56            16.06.03

The errors are stored in a ring buffer with a maximum of 20 errors, i.e. the oldest error is overwritten by a new one when the memory is full.

The memory of the error history is deleted with "delete" and recording is started anew.

The list is not deleted after a power failure.

ERROR HISTORY
display
delete

## Status history

Open the status history via "show". The status history is a list of statuses which have occurred during current operation.

The occurred status is recorded with time and date, e.g.:

A. Reg F1: 23.7m<sup>3</sup>  
21:28 30.09.03

A maximum of 20 statuses is logged in a ring buffer.

The memory is deleted with "delete" and recording is started anew. The list is not deleted after a power failure.

Description of abbreviations:

A. RegF1: xxx m<sup>3</sup> = automatic regeneration triggering in case of xxx m<sup>3</sup> consumption, e.g. by reaching the capacity or via interval.

M. RegF1: xxx m<sup>3</sup> = manual regeneration triggering in case of xxx m<sup>3</sup> consumption, manual start

E. RegF1: xxx m<sup>3</sup> = external regeneration triggering in case of xxx m<sup>3</sup> consumption via START contact.

F1 -> F2: xxx m<sup>3</sup> = Filter change from filter 1 to filter 2 in case of xxx m<sup>3</sup> consumption.

F2 -> F1: xxx m<sup>3</sup> = Filter change from filter 2 to filter 1 in case of xxx m<sup>3</sup> consumption.

## Diagnosis

The actual statuses of the inputs and outputs are displayed in the diagnosis menu. The statuses of the inputs can be manually manipulated via the "DOWN" and "UP" keys for test purposes, e.g. when commissioning. Please ensure that downstream plant components cannot be damaged.

Active statuses (switched relay, connected input) are displayed with "on", inactive statuses with "off", e.g.:

OUTPUT BV    or    INPUT LL  
    off                    on

## Software status

Request the current software status here:

STATUS HISTORY
display
delete

TEST IN/OUT
Output Fi1
Output Fi2
Output Sync
Output BV
Output AL/PR
Input WM
Input LL
Input Prog
Input Start
Input Stop

SOFTWARE STATUS
94Mxxx TT.MM.JJ

# Menu structure

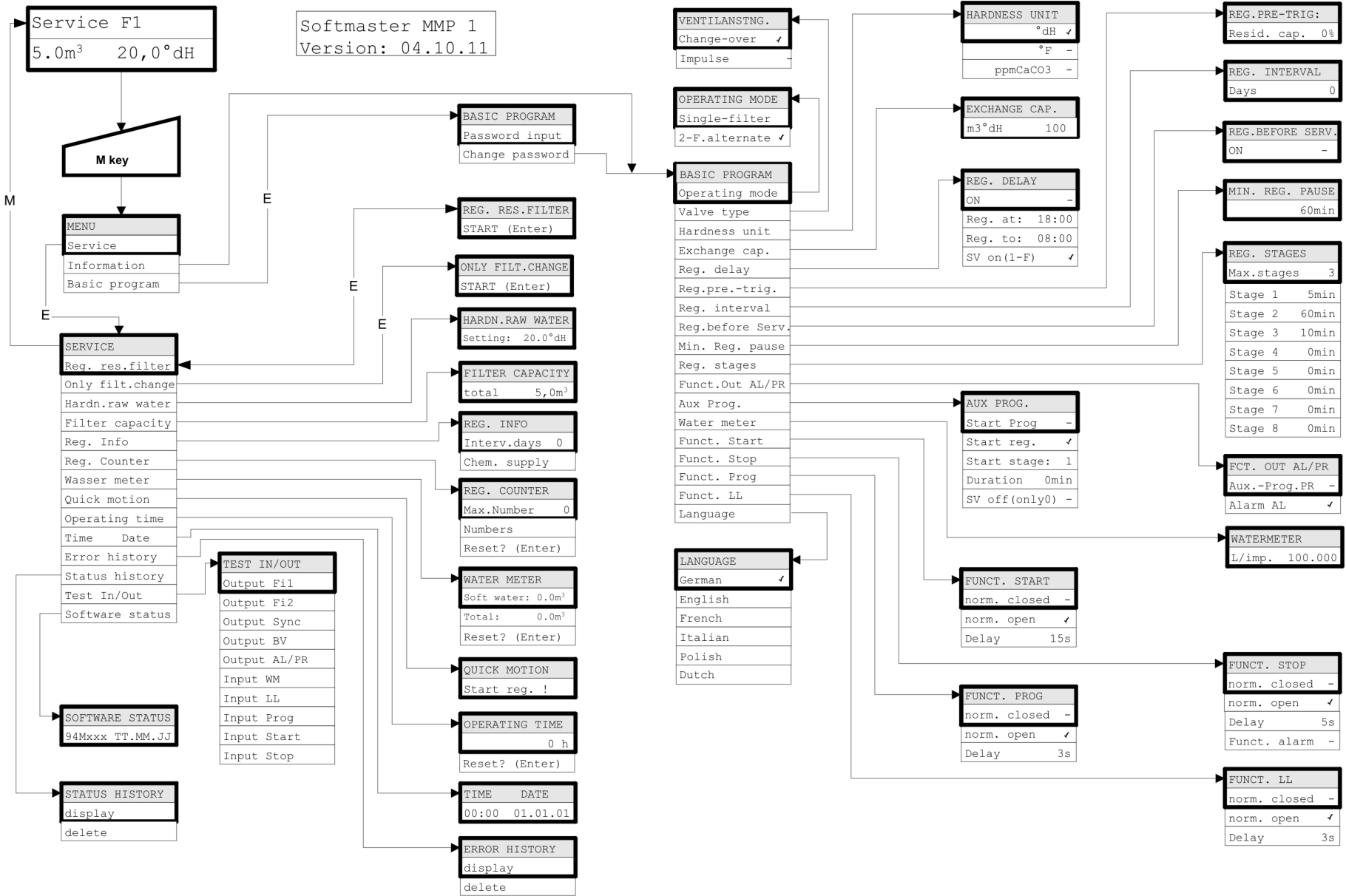

Call the basic factory default setting by simultaneously pressing and holding down the „Arrow down“ key while switching on the instrument. The most recent programming will be lost!



# Technical Appendix

## Example for a 2-filter softening plant

Plant example for double-filter softening with Softmaster MMP and electric pilot valves PVE  
Measurement of total water hardness and quality-dependent regeneration with Testomat 2000 DUO

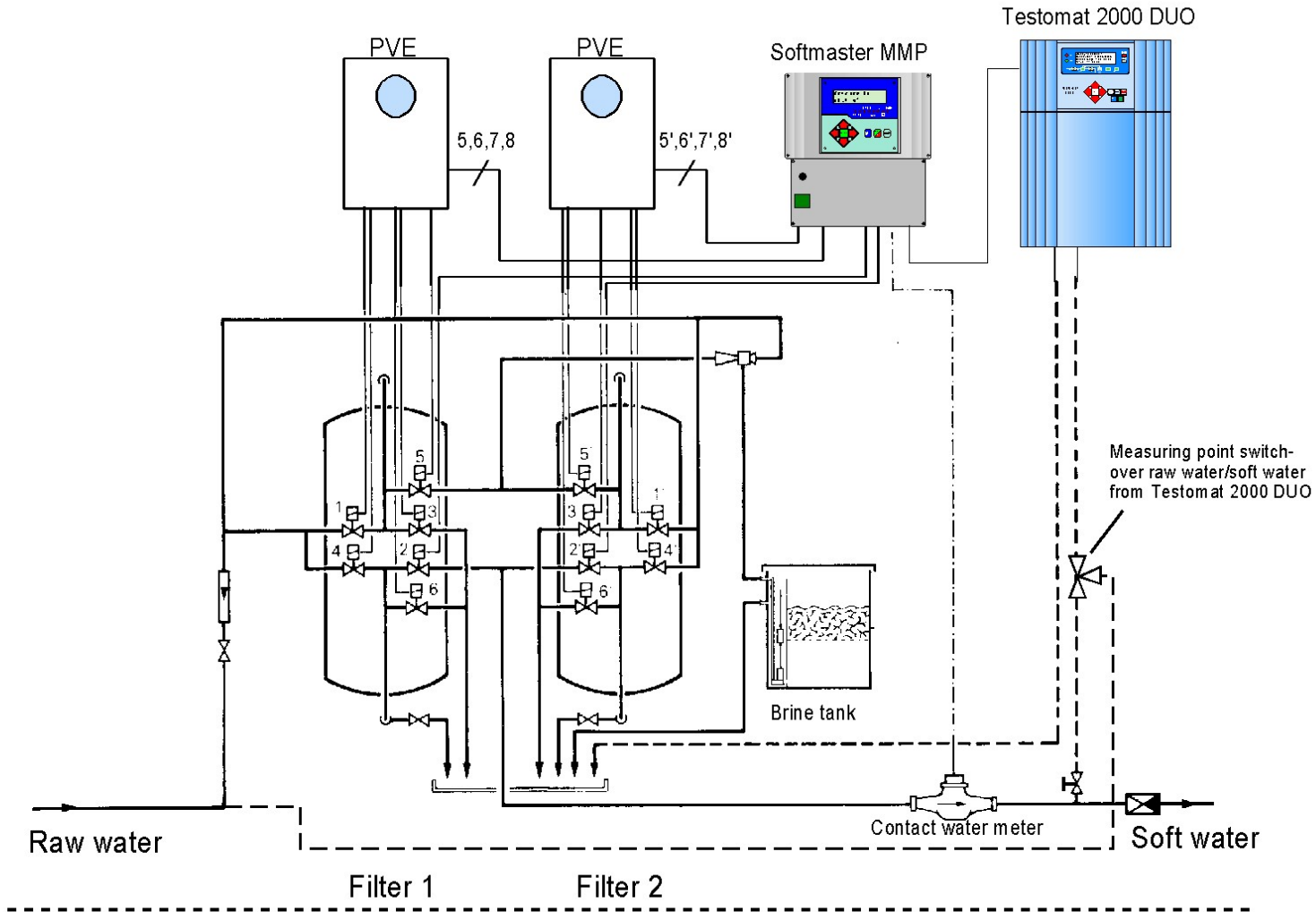

# Connection example

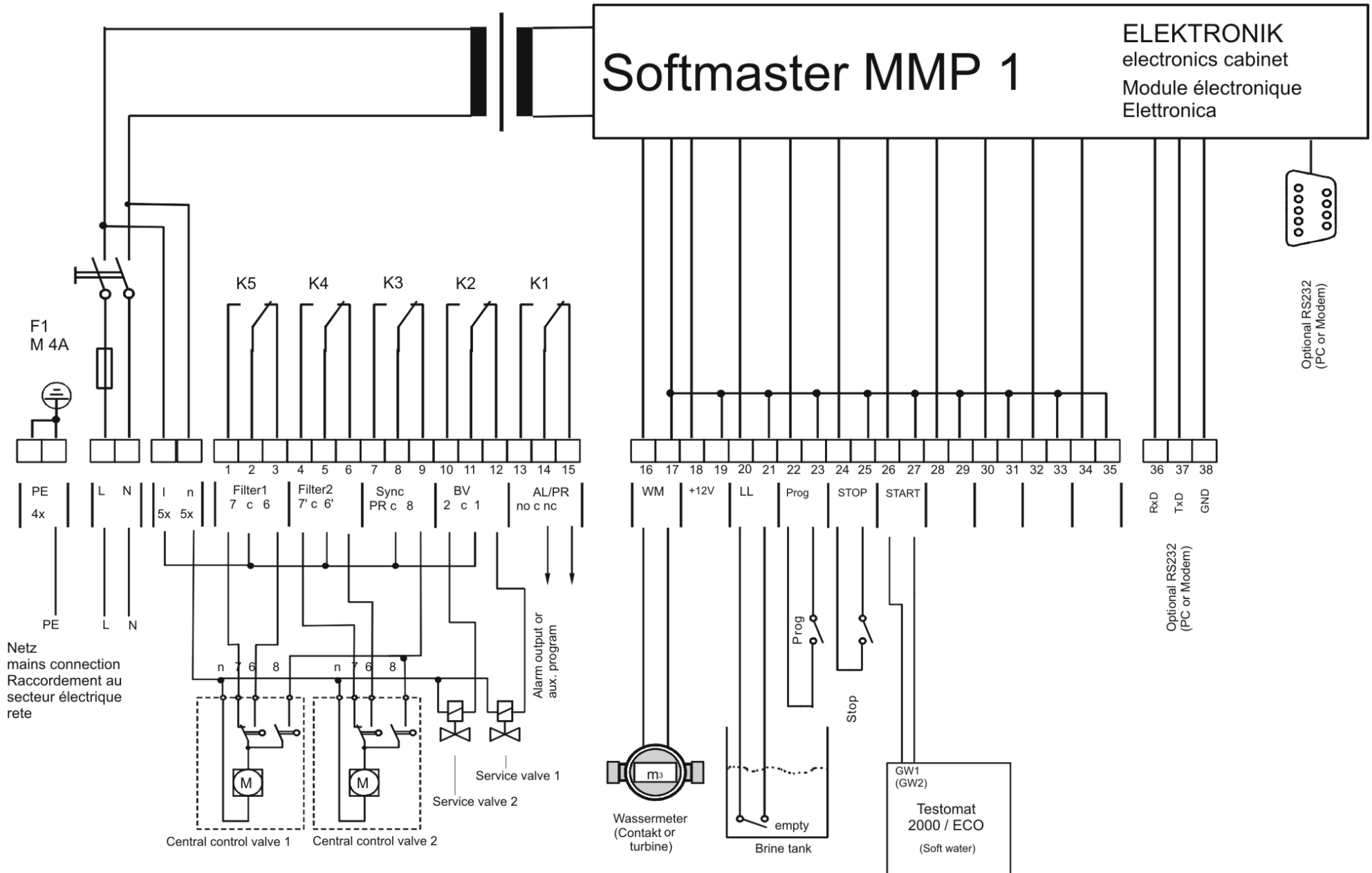

## Conformity Declaration



EC Conformity Declaration



### for the following product

**Softmaster MMP 1**  
**Microprocessor controller for softening plants**

We hereby confirm that the above product conforms to the principal health and safety regulations laid down in the EC Directives 2014/30/EU and 2014/35/EU.

This declaration applies to all units produced in accordance with the attached manufacturing documents which are a constituent part of this declaration.

**The product was assessed with reference to the following standards:**



**EN 61000-6-4:** Electromagnetic compatibility, Generic emission standard

**EN 61000-6-2:** Electromagnetic compatibility, Generic immunity standard

**EN 61010-1:** Safety requirements for electrical equipment for measurement, control and laboratory use



**BS EN 61000-6-4+A1:** Electromagnetic compatibility, Generic emission standard

**BS EN 61000-6-2:** Electromagnetic compatibility, Generic immunity standard

**BS EN 61010-1+A1:** Safety requirements for electrical equipment for measurement, control and laboratory use

This declaration is made on behalf of

**GEBRÜDER HEYL**  
**Analysentechnik GmbH & Co. KG**  
**Orleansstraße 75b**  
**31135 Hildesheim**

by

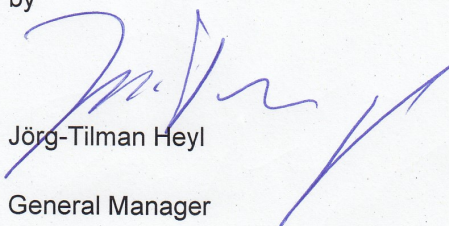
  
Jörg-Tilman Heyl

General Manager

Hildesheim, 16/09/2021

## Technical data

<b>Power supply:</b>	230 - 240 V or 24 V or 115V+/-10% / 50 -60 Hz, fuse T6,3A
<b>Power consumption without exterior load:</b>	max. 9 VA
<b>Degree of protection:</b>	IP65
<b>Protection class:</b>	I
<b>Conformity:</b>	EN 61000-6-2, EN 61000-6-4, EN 61010-1 BS EN 61000-6-4+A1, BS EN 61000-6-2, BS EN 61010-1+A
<b>Ambient temperature:</b>	0 – 45C
<b>Housing dimensions wall-mounted/panel-mounted variant:</b>	W x H x D = approx. 270 x 295 x 130 mm Housing made of ABS Panel cut-out 262mm x 146mm, +1mm, Mounting depth approx. 90mm, Front frame dimensions 270mm x 155mm
<b>Weight:</b>	Approx. 1.3 kg



**We reserve the right to make technical changes without notice in the interest of constantly improving our products!**

Softmaster\_MMP1\_GB\_111028.doc



Gebrüder Heyl  
Analysentechnik GmbH & Co. KG  
Orleansstraße 75b  
D 31135 Hildesheim  
[www.heylandanalysis.de](http://www.heylandanalysis.de)



Scan the code and  
visit us on our website!