

Operating Instructions Testomat ECO[®] C

Online analysis instrument
for carbonate hardness



Contents

Contents	2
Important safety information	4
Intended use	4
Qualification of the staff	4
Warning notices in these instructions	5
Further documents	5
Pay particular attention to	5
General instructions	5
Properties of the measured water	5
Installation	6
Operation	6
After switch-off and longer downtime.....	6
Cleaning	7
De-installation	7
Disposal	7
Scope of delivery	8
Performance specifications	8
Indicators for Testomat ECO [®] C instruments	9
Application instructions	10
Installation	11
Operating Testomat ECO [®] C in the pressure range 0.3 to 1 bar	11
Installing Testomat ECO [®] C.....	11
Connecting the water inlet and outlet	12
Water inlet.....	12
Water outlet.....	12
Connecting the power supply and devices	13
Block diagram Testomat ECO [®] C	13
Internal design Testomat ECO [®] C	14
Connecting the mains voltage.....	15
Connecting the plant components	16
Connecting the inputs and outputs	17
Commissioning	18
Inserting the indicator bottle.....	18
Extracting the indicator	18
Opening the water inlet	18
Instrument settings and data input.....	19
Functions of the operating and display elements	19
Switching Testomat ECO [®] C on/off	19
Display functions	19
Operating elements and function keys	21
Operating system.....	22
Entering basic program data	23
Selecting the indicator.....	23
Selecting the operating mode	23
Selecting the time control.....	23
Setting the analysis interval (interval pause)	24
Selecting the quantity control.....	24
Selecting the type of water meter	24
Selecting the quantity control/time priority	25

Selecting the display unit	25
Entering the flushing time	25
Limit value monitoring	26
Hysteresis	26
Switch functions of the limit value outputs LV1 and LV2	27
Switch function duration	27
Switch function duration/inverse	27
Switch function two-point/inverse	27
Description of the signal inputs/outputs	28
Stop input	28
Water meter input	29
Current interface 0/4 - 20 mA	29
Calculating the output currents	30
Description of the relay outputs	31
LV1 and LV2 limit value outputs	31
Alarm/Message (fault message output)	32
Information menu "i"	33
Program menu "M"	34
Structure of the basic program	36
Error messages/Troubleshooting	37
Further information	38
Checking the dosing pump	38
Maintenance	39
Description of maintenance work	39
Service instructions	40
Testomat ECO[®] C spare parts and accessories	41
Accessories	42
Technical data	43
Conformity Declaration	44
Check List Testomat ECO [®] C	45
Product overview Testomat 2000[®]-Instruments	47



Important safety information

- Please read these operating instructions carefully and completely prior to working with the instrument.
- Ensure that these operating instructions are always available for all users.
- These operating instructions must always be passed on to the new owner should Testomat ECO[®] C change hands.
- Always adhere to hazard warnings and safety tips when using reagents, chemicals and cleaning agents. Please adhere to the respective safety data sheet! Download the safety data sheets for the supplied reagents at <http://www.heyl.de>.

Intended use

Testomat ECO[®] C is used for the automatic determination and monitoring of carbonate hardness in water. The required measuring range is determined by the indicator selection and the respective user programming.

- Always adhere to the performance limits stated in the section entitled "Technical data".
- Always observe the application areas/application limits of the indicators and the requirements of the medium being measured.

To ensure correct and intended usage, always read and understand these instructions, especially the section entitled "Important safety information", prior to use.

The instrument is not used as intended if

- it is used in areas not specified in these instructions
- it is used in areas which do not correspond to the ones described in these instructions.

Qualification of the staff

Assembly and commissioning require fundamental electrical and process engineering knowledge as well as knowledge of the respective technical terms. Assembly and commissioning should therefore only be carried out by a specialist or by an authorised individual supervised by a specialist.

A specialist is someone who due to his/her technical training, know-how and experience as well as knowledge of relevant regulations can assess assigned tasks, recognise potential hazards and ensure appropriate safety measures. A specialist should always adhere to the relevant technical regulations.

Warning notices in these instructions

The warning notices in these instructions warn the user about potential dangers to individuals and property resulting from incorrect handling of the instrument. The warning notices are structured as follows:



SIGNAL WORD!

Description of the type or source of error

Description of the consequences resulting from non-observance

- Preventive measures. Always adhere to these preventive measures.



DANGER

“**DANGER**” indicates an immediate hazardous situation which, if not avoided, will result in death or serious injury.



WARNING

“**WARNING**” indicates a potentially hazardous situation which, if not avoided, could result in death or serious injury.



CAUTION

“**CAUTION**” indicates a potentially hazardous situation which, if not avoided, could result in minor or moderate injuries or property damage.

NOTE

“**NOTE**” indicates important information. If this information is not observed, it may result in an undesirable result or state.

Further documents

Testomat ECO[®] C is a plant component. Therefore, always observe the maintenance manual of Testomat 2000[®]/ECO[®] and the documentation of the plant manufacturer.

Pay particular attention to

General instructions



WARNING

- Adhere to national and local regulations during installation and commissioning.
- Adhere to national health and safety regulations as well as environmental protection regulations in the country of use and at the installation site.
- Do not carry out any changes or actions at the instrument which are not described in these instructions; failure to adhere to these instructions will negatively affect any warranty claims that you make thereafter.
- Trouble-free operation of Testomat ECO[®] C is only guaranteed when using Heyl Testomat 2000[®] indicators in the pH-range 4 – 10.5!

Properties of the measured water

- The pH value of the aqueous solution must be above 4.3. In the case of pH values below 4.3, “Measurement fault analysis” will be displayed.

- If the measuring water contains more than 20 mg/l CO₂ (carbonic acid), erroneous evaluations cannot be excluded (if necessary, use aerator type R).
- The concentration of influencing contents can be determined by using our colourimetric TESTOVAL[®] test kit.

Installation



- Always completely disconnect the relevant plant part before installing the instrument or connecting/disconnecting it to/from the power supply. Secure the plant against reconnection.
- Only connect the instrument to the mains voltage specified on the rating plate.
- Always observe technical data and ambient parameters.
- Testomat ECO[®] C requires an interference free and stable power supply. If necessary, use a mains filter to protect Testomat ECO[®] C against interference voltages caused, e.g., by solenoid valves or large motors. Never lay connecting cables parallel to power cables.



Operation

- Ensure that the maximum electrical load capacity of the relay outputs is never exceeded.
- Immediately switch off Testomat ECO[®] C and contact service staff if malfunctioning occurs. The warranty will be void if you tamper with or attempt to repair Testomat ECO[®] C. Repairs must be carried out by authorised service staff.

After switch-off and longer downtime

- Ventilate the indicator leads as described in the start-up, because longer downtimes (more than 6 hours) can cause the indicator in the leads to retract.
- Do not switch off the appliance for longer periods (e.g. over the weekend) via the start/stop output. The indicator can retract from the leads. This results in measurement errors after the appliance is switched on.

Cleaning

- Only use a dry, lint-free cloth for cleaning.

De-installation

- Prior to de-installing a defective instrument, always write down a description of the error (failure effect). It is only possible to repair a defective instrument (irrespective of the warranty period) if it has been de-installed and returned to us with a description of the error.

Disposal

- Dispose of the instrument in accordance with national regulations.

Scope of delivery

- 1 Testomat ECO[®] C
- 1 plastic bag with screw cap with a hole and an insert for the screw cap of the indicator bottle
- 1 operating instructions

Performance specifications

Testomat ECO[®] C is used for the automatic determination and monitoring of residual total hardness (water hardness) in water. The required measuring range is determined by the indicator selection and according to the user programming.

- Simple, menu-driven operating and programming via a plain text display
- Determinable measuring of total hardness (water hardness)
- Freely selectable hardness unit in °dH, °f, ppm CaCO₃ or mmol/
- High measuring accuracy provided by a precise piston-dosing pump
- control of indicator dosage
- Extended operating periods due to 500 ml indicator storage bottle
- Analysis initiation:
 - Automatic interval operation (interval pause can be set from 0-99 minutes)
 - Quantity dependent via impulse water meter/turbine
 - External analysis stop
- Two independent limit values with hysteresis (1, 2 or 3 bad analyses) and settable switch functions (two neutral change-over contacts)
- Fault message output (neutral change-over contact)
- Current output 0/4 - 20 mA

Error messages if indicator is in shortage

Besides the volume in the indicator bottle, the dosage of the indicator is also monitored in the measuring chamber. This leads to two different error messages:

1. If the amount of indicator in the bottle is less than 10%, the error message "Reag. low level" will be displayed.
 2. If no indicator is injected into the measuring chamber, the error message "No Reagent" will be displayed.
-

NOTE

Indicators for Testomat ECO[®] C instruments

		Indicator type	
		Carbonate hardness	
		TC 2050*	TC 2100
Unit	°dH (resolution)	0,5 - 10,0 (0,5)	1,0 - 20,0 (1,0)
	°f (resolution)	0,90 – 17,9 (0,9)	1,8 - 35,8 (1,79)
	ppm CaCO₃ (resolution)	9 - 179 (8,9)	18 - 358 (18)
	mmol/l (resolution)	0,18 – 3,58 (0,18)	0,36 - 7,16 (0,36)

* extended measuring range

Application instructions

- **Switching on/off**
Wait at least 5 seconds before switching the instrument on and then off again at the main switch.
- **Ambient conditions/Installation site**
Always protect the instrument against moisture and humidity. It should never come into contact with condensation or splash water.
- **Malfunctioning/Repairing a defective instrument**
The repair of a defective instrument – irrespective of the warranty period - is only possible after the instrument has been dismantled and returned to us with a description of the error. Furthermore, please inform us of the indicator type being used and the measured medium. Do not carry out any actions at the instrument which are not described in these instructions; failure to adhere to these instructions will negatively affect any warranty claims that you make thereafter. Before you return the instrument for repair, write down a description of the error (failure effect). Repair work repair work, remove the bottle and ensure that the measuring chamber has been flushed out and is empty. Prior to dismantling, always (irrespective of the warranty period) is only possible when the instrument is dismantled and returned to us with a description of the error.
- After a protective circuit (fuse) has been tripped, attempt to eliminate the cause of malfunctioning (e.g. replace a defective valve) before reactivating the protective circuit. Frequent tripping is always due to an error which, in certain circumstances, may also cause damage to the instrument.
- **Operating safety instructions**
Careful handling of the instrument increases both its operational reliability and service life! Therefore, carry out a visual inspection at regular intervals as described below:
 - Are the hose connections of the dosing pump free of leaks?
 - Is there any air inside the dosing hoses?
 - Are all the water connections free of leaks?
 - Are the doors of the instrument closed properly?
 - Is the instrument heavily soiled?
- **Maintenance and servicing instructions**
(For more information, please refer to the section entitled "Maintenance" and the "Maintenance manual of Testomat 2000® / Testomat ECO®)

Installation



Risks resulting from incorrect installation!

- Install Testomat ECO® C at a location where it is protected against dripping or splash water, dust and aggressive substances – e. g. in a switch cabinet or on a suitable wall.



Information for trouble-free operation

- Install Testomat ECO® C vertically and without mechanical stress.
- Install Testomat ECO® C at a vibration-free site.

Operating Testomat ECO® C in the pressure range 0.3 to 1 bar

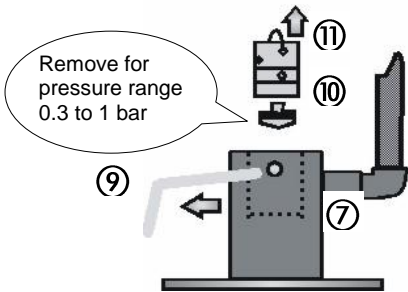

Prior to installation, please check whether lower operating pressure is required. The instrument is factory set for the operating range 1 to 8 bar. Remove the flow controller valve body ⑩ to operate the instrument in the operating range 0.3 to 1 bar (e.g. when using an aerator type R). This involves removing the retaining pin ⑨ from the controller / filter receiver ⑦. Subsequently use the metal bracket to remove the controller plug ⑪ from the borehole. Subsequently remove the flow controller valve body ⑩ and reinsert the controller plug and the retaining pin.

Installing Testomat ECO® C

Select an installation site where the water inlet hose can be kept as short as possible (max. 5 m)

- Please leave sufficient space on the left-hand side of the instrument to open the door
- Drill the mounting holes as shown in the drawing on the left.
- Use three screws to attach the instrument at a suitable position in the switch cabinet or on a wall.

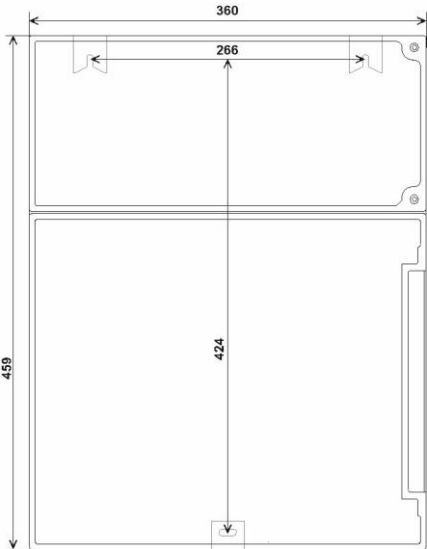

Connecting the water inlet and outlet

NOTE

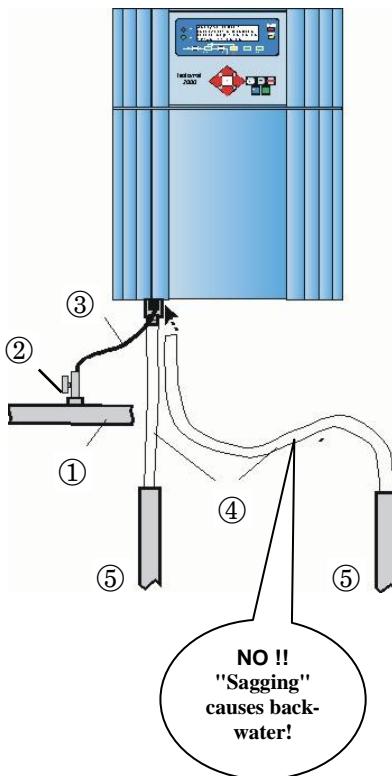

CAUTION

Information for trouble-free operation

- The water pressure must be between 0.3 bar and 8 bar
- Avoid strong pressure fluctuations
- The measuring water temperature must be between 10 °C and 40 °C
- For temperatures above 40°C, the KCN type cooler should be installed in the branch line of Testomat ECO® C.

Water inlet

The measuring water is taken from the main water line of the water treatment plant and fed to the inlet connection of Testomat ECO® C. The instrument is equipped with a plug connector for plastic hoses 6/4 x 1 (external diameter 6 mm/ internal diameter 4 mm, wall thickness 1 mm) as standard.

- Install the connection for the branch line of Testomat ECO® C directly at the main water line ① directly after the water treatment plant
- It is important that the branch line connection is laid vertically upwards in order to prevent dirt particles from entering the instrument from the main water line
- Install a manually operated shut-off valve ② in the branch to Testomat ECO® C.
- Use an opaque plastic hose 6/4 x 1 (max. length 5 m) for the water inlet ③
- Flush the inlet to remove any dirt particles

When using a cooler

- **The hot water can cause burns and damage wetted parts of Testomat ECO® C.**

Water outlet

The feed water flows through the measuring chamber to the drain via the outlet hose.

- Connect the outlet connection of Testomat ECO® C to an outlet hose ④ (internal diameter 14 mm)
- Lay this hose without **backwater development** and any syphoning effect, e.g. via an open funnel, to the drain.⑤

Connecting the power supply and devices



WARNING

Risk of electric shocks during installation!

If the power supply is not disconnected prior to installation, it may result in personal injuries, destruction of the product or damage to plant parts.

- Always disconnect the relevant plant parts before installing Testomat ECO[®] C.
- Only use tested cables with sufficient cross-sections for the connections.

NOTE

Risk of damages caused by electromagnetic fields!

- If Testomat ECO[®] C or the connecting cables are installed parallel to power cables or in close proximity to electromagnetic fields, the instrument may be damaged or measurements incorrect.
- Ensure that connecting cables are as short as possible.
- Always install connecting cables and power cables separately.
- Connect the instrument to the protective earth conductor (for 230/115 VAC).
- Protect Testomat ECO[®] C against interference voltages – e.g. via a mains filter.
- Shield the instrument against strong electromagnetic fields.

Block diagram Testomat ECO[®] C

Drawn relay positions: Instrument de-energised, mains: 230/115 V

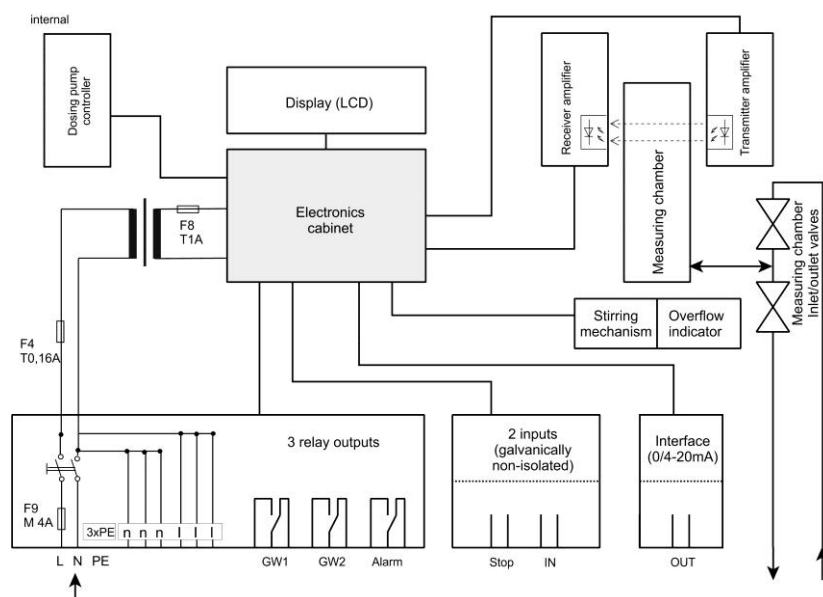

① Internal design Testomat ECO® C

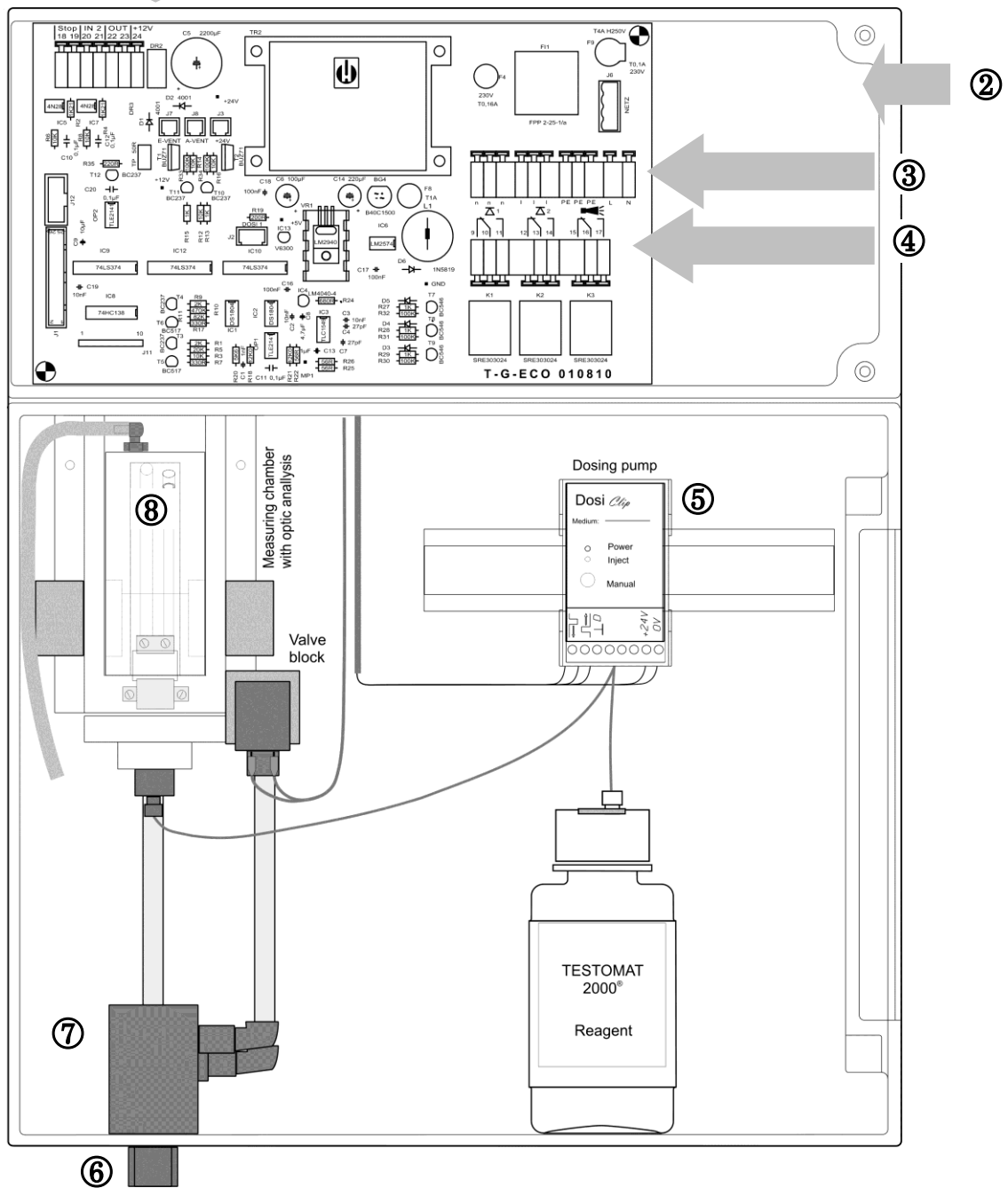

①	Terminal strip for inputs Stop, IN2, output OUT, +12 V for turbine
②	Mains switch
③	Terminal strip for power input and power output
④	Terminal strip for relay outputs
⑤	Dosing pump
⑥	Water connections, inlet and outlet
⑦	Controller / filter receiver
⑧	Measuring chamber

Connecting the mains voltage

Only connect the instrument to the specified mains voltage. Refer to the rating plate for the appropriate mains voltage. Connect the cables as follows:



- Loosen both fastening screws ① and open the upper door. The terminal box is now accessible.
- Pierce the required rubber cable glands ② with a screwdriver and insert the cable through the bush into the terminal box (1)
- Subsequently pull back the cable until the bush has been turned over (2)
- Connect the power supply to terminals PE,N,L or for 24 V instruments to terminals U,V.
- Ensure that the leads are held securely in the terminals.

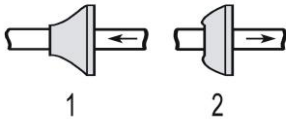

Terminal description	Typ et	Function	Comment
PE	IN	Mains – protective earth (3x)	Only with mains 115/230 V !
N (U) L (V)	IN	Mains, N=neutral (U=24 V) Mains, L=live (V=24 V)	Mains input 24 V / 115 V / 230 V
n I	OUT	Neutral, switched (3x) Live, switched (3x)	Mains for consumers, max. 4 A

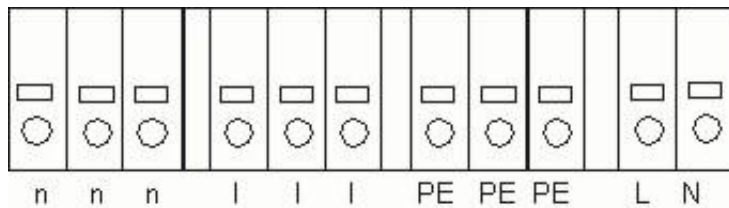

Connecting the plant components

Connection example:
Limit value contact LV 1
switches mains voltage

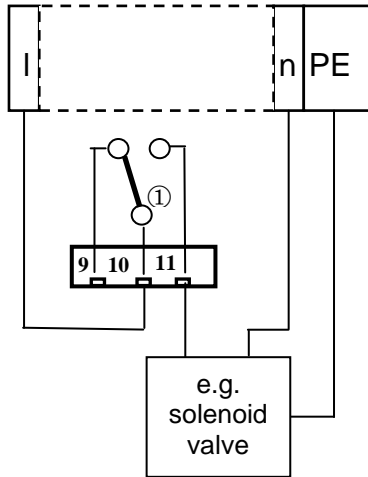

- Connect the plant components to the output terminals of relays 9 to 17 (e.g. valves).
- If the plant components require mains voltage, connect the switched mains voltage (I) to the common contact ① of the respective relay (see the connection example for 230 VAC on the left).
- Connect the neutral conductor of the plant component to one of the terminals (n)
- For components with a protective earth conductor connection, connect it to the PE connection.
- Ensure that the leads are held securely in the terminals.

(Drawn relay positions: Instrument de-energised, mains: 230/115 V)

No.	Terminal description	Type	Function	Comment
9 10 11	LV1	OUT	Limit value output 1 – Normally closed Limit value output 1 – Common Limit value output 1 – Normally open	Isolated relay output, max. 240 VAC, 4 A
12 13 14	LV2	OUT	Limit value output 2 – Normally closed Limit value output 2 – Common Limit value output 2 – Normally open	Isolated relay output, max. 240 VAC, 4 A
15 16 17	Alarm	OUT	Fault message output – Normally closed Fault message output – Common Fault message output – Normally open	Isolated relay output, max. 240 VAC, 4 A

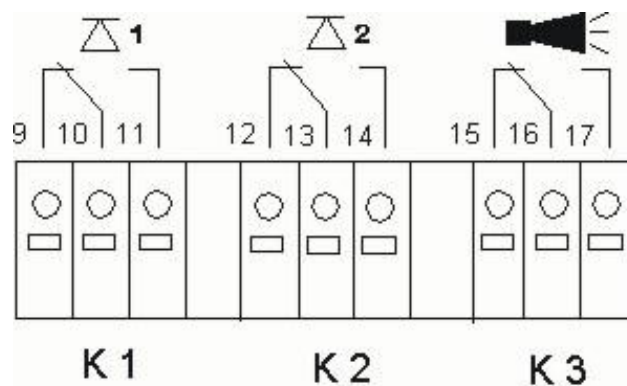

Connecting the inputs and outputs

Testomat ECO[®] C has the following connections for control and monitoring functions.

- Do not connect external voltage to these connections!
- Ensure that the leads are held securely in the terminals
- Use the two fastening screws to close the upper door once installation has been completed.

No.	Terminal description	Type	Function	Comment
18 19	Stop	IN	External analysis stop Common earth for inputs	Only for isolated normally closed/normally open!
20 21	IN	IN	Water meter input Common earth for inputs	Only for isolated normally closed/normally open; or observe the technical data of the turbine!
22 23	OUT - OUT +	OUT	Current interface 0/4 - 20 mA	Galvanically separated
24	+	OUT	+12 V for Hall sensor (turbine)	Observe the technical data of the turbine! Max. output current 20 mA!

Stop 18 19	IN 20 21	OUT 22 23	+12V 24
⊥	⊥	- +	

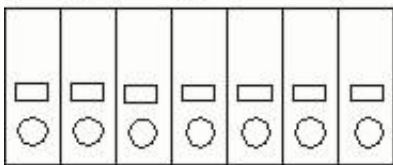

For more information, please refer to the section entitled "Description of the signal inputs/outputs".

Commissioning

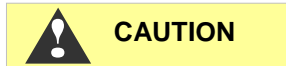

CAUTION

Trouble-free operation of Testomat ECO® C is only guaranteed when using Heyl Testomat® indicators!

Inserting the indicator bottle

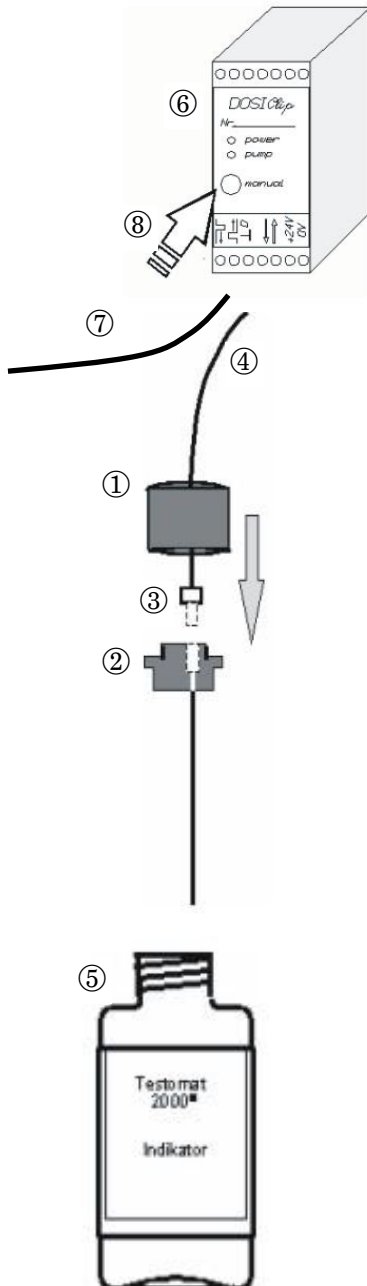

- Open the lower housing door by pulling on the right-hand side.
- Remove the cap from the indicator bottle.
- Remove the plastic bag from inside the lower housing door. The plastic bag contains the screw cap with hole ① and the insert ② for the screw cap.
- Connect the parts as shown on the left.
- Screw the hose connector ③ of the intake hose ④ hand-tight into the insert ②.
- Place the insert with the screwed-in intake hose into the indicator bottle.
- Now screw the screw cap with hole ① hand-tight onto the indicator bottle. ⑤

Extracting the indicator

- Switch the instrument on and press the "STANDBY" key
- During operation, the pump (DOSIclip) ⑥ automatically extracts the indicator
- To ensure that indicator is available for the initial analyses, the intake hose ④ and the transport hose ⑦ must be filled with indicator from the pump up to the measuring chamber.
- Press the "manual" ⑧ key several times until the intake hose ④ and the transport hose ⑦ are filled with indicator up to the measuring chamber.
- If necessary, manually tighten the hose connectors of the intake and transport hose slightly in case of bubble formation.

Opening the water inlet

- Open the lower housing cover.
- Slowly open the manually operated shut-off valve to prevent the measuring chamber overflowing. The flow regulator requires a few seconds to function correctly.
- Make sure that the water conducting parts are not leaky.

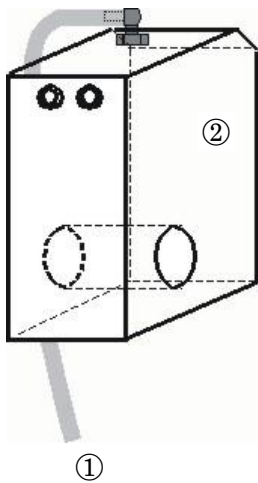

- If water sprays from the tube ① of the measuring chamber ②, reduce the amount of inlet water via the manually operated shut-off valve. It should take 2 to 6 seconds to fill the measuring chamber!

Instrument settings and data input

- Please read the following information before carrying out settings and entering data for operating the instrument.

Functions of the operating and display elements

The Testomat ECO[®] C display shows operating statuses and measured values. The input keys for programming (cursor block) and the function keys are located underneath the display.



Switching Testomat ECO[®] C on/off

- (1) Mains switch
Use this switch to switch the instrument on or off.
- (2) Instrument fuse (inside the instrument)
This fuse protects Testomat ECO[®] C and the outputs against overloads and short circuits.

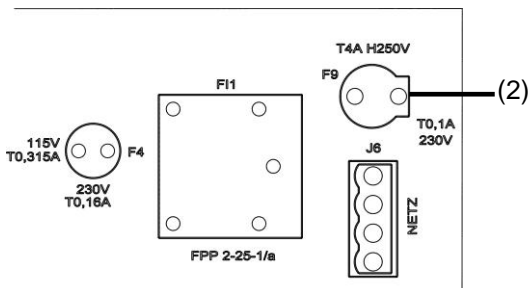

Display functions

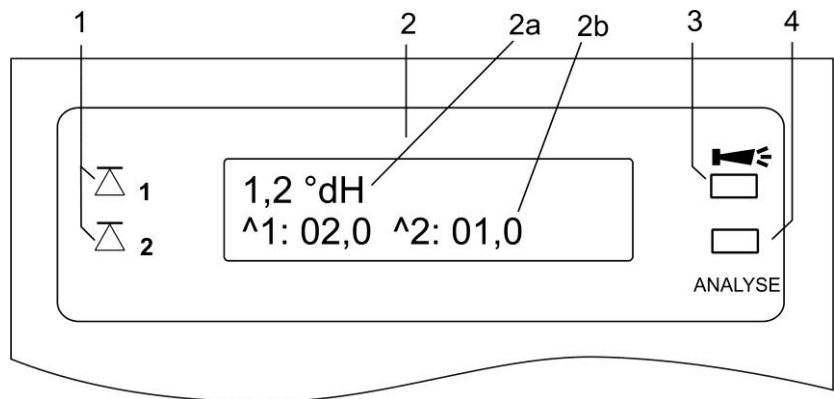

1 Limit value status displays (red/green)

Duration switch function:

If limit 1 is reached or exceeded, display 1 lights up red. If the limit is not exceeded, display 1 is green. The same principle applies to limit 2 and display 2.

Duration/inverse switch function:

If limit 1 is not exceeded, display 1 is red. If the limit is reached or exceeded, display 1 lights up green. The same principle applies to limit 2 and display 2.

Two point/inverse switch function:

If limit 3 is not exceeded but limit 4 is, both LEDs are red. If the measurement value is between these two limits, both LEDs are green.

All error and warning messages are alternately shown in line 1 of the standard display!

2 Text display (2 lines)

Displays the current analysis result as well as all important statuses and programming data.

2a = The current measured value is displayed in line 1

Value falls below the measuring range = "<" e.g.: < 0.5 °dH

Value exceeds the measuring range = ">" e.g.: > 5.0 °dH

If the current analysis interval (analysis stop) is interrupted, "STANDBY" is displayed alternately with the measured value.

2b = The set limit values LV1 and LV2 are displayed in line 2.

3 Alarm (red)

Indicates malfunctioning/error message or warning message.

4 Analysis message (yellow)

The yellow LED indicates a current analysis.

NOTE

Cancelling error messages/warning messages





- Eliminate the fault and acknowledge the message via the "Horn" key.

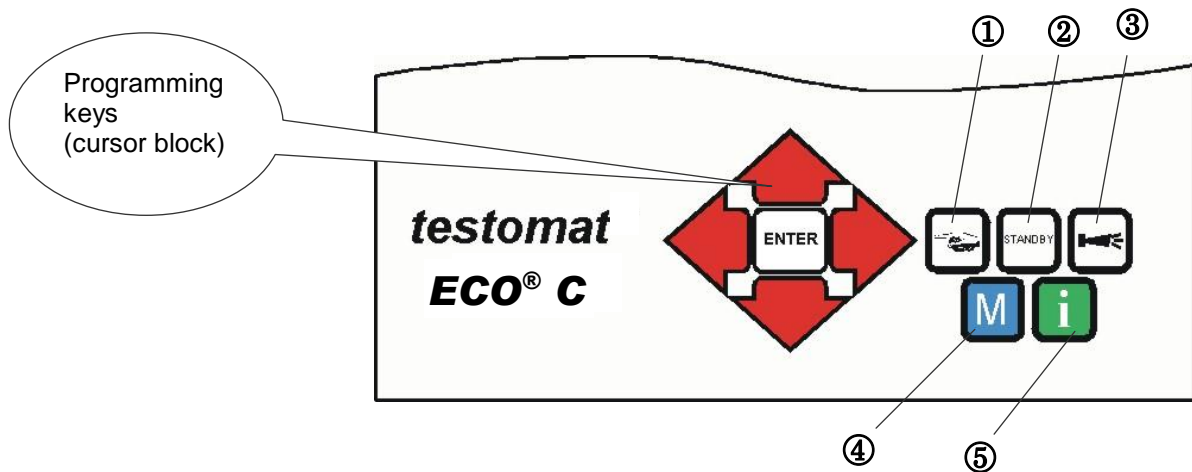

Operating elements and function keys



Function keys

	Manually start an analysis via the " Manual " ① key
	Set the instrument to standby mode via the " STANDBY " ② key (automatic analyses are not carried out: analysis stop)
	Acknowledge error and warning messages via the " Horn " ③ key
	Open the program menu for user-specific and instrument-specific settings via the " M " ④ key
	Retrieve all instrument information and settings via the " i " key

(M)enu key



Cursor block



If you wish to carry out settings or enter data, or if alterations are necessary, press the "**M**" key to open the programming mode. Use this key when *in the menu* to go to the higher order menu items or to exit the programming mode.

Programming keys (cursor block)

Use the programming keys (cursor block) to navigate in the menu, to select the desired functions and to enter necessary instrument and plant specific data. Press the "ENTER" key to select the submenu item and to confirm and accept the selection or data input. The selected menu items are displayed in capital letters.

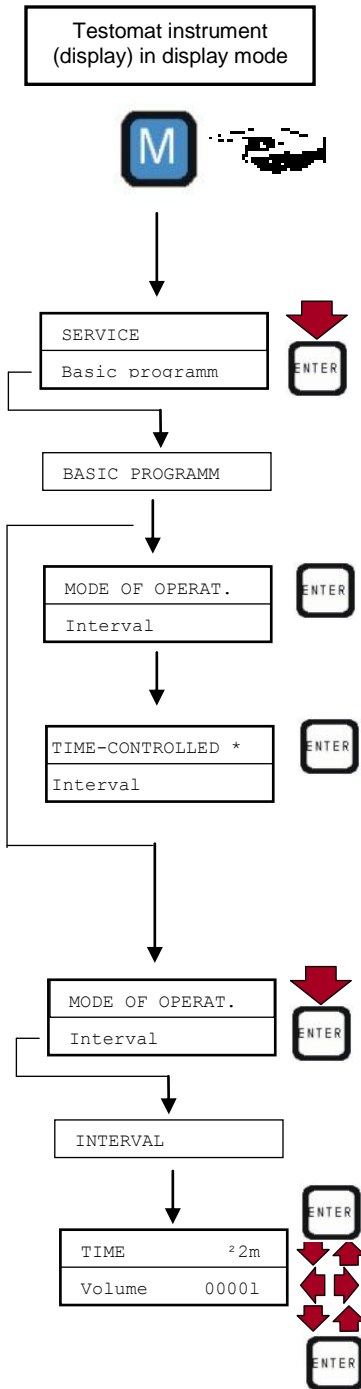

Operating system

SELECTING FUNCTIONS (example: "select operating mode")

- Press the "M" key
"SERVICE" or "Basic program" is displayed
- Use the cursor block to select the desired menu item "Basic program"
The selection appears in CAPITAL LETTERS.
- Press "ENTER" to confirm your selection
"MODE OF OPERAT." or "Interval" is displayed

The menu item "OPERATING MODE" has already been selected (capital letters)

- Press "ENTER" to confirm the menu item "MODE OF OPERAT."
"TIME CONTROLLED" or "Interval" is displayed
- Use the cursor keys to select the desired function
- Press "ENTER" to activate/deactivate the function
(An asterisk " * " is displayed when the function has been activated)

The selected function has been activated/deactivated.

Note: You can select both functions here.

ENTERING DATA (example: interval pause/quantity interval)

Program the interval pause between two analyses in the menu item "Interval".

After confirming the menu item "BASIC PROGRAM" via "ENTER", proceed as follows to set the interval pause:

- Use the cursor block to select the menu item "Interval"
- Press "ENTER" to confirm your selection
- "TIME" or "Volume" is displayed
- Press "ENTER" to confirm the menu item "TIME"
The cursor flashes at the first position of the time: "■2"
(it is possible to enter values from 0 to 99 minutes)
- Use the cursor keys to select the desired digit for the first position
- Use the keys to move the cursor to the second input field
- Use the cursor keys to select the desired digit for the second position
- Press "ENTER" to confirm the entry
The time interval has now been entered.

Enter the quantity interval in the same way after selecting the menu item "VOLUME". Select the four digits and confirm via "ENTER". It is possible to enter values between 1- 9999 litres.



Entering basic program data

Selecting the indicator

TYPE TC2050	*
Type TC2100	

- In the menu, select => BASIC PROGRAM
=> MODE OF OPERAT. => TYPE OF REAGENT
- Press "ENTER" to confirm the menu item "TYPE OF REAGENT "

The selection shown on the left is displayed.

- Select the indicator type  
- (The indicator type TC2050 " * " is factory set)
- Press "ENTER" to confirm the selection
(An asterisk " * " appears at the end of the line)

The asterisk " * " displays the active menu item.
The indicator has now been selected.

Selecting the operating mode

Under the menu item "OPERATING MODE" it is possible to select the type of analysis controller. Time control or quantity control via water meter, or a combination of both, is possible with Testomat ECO® C.

Time control
Internal start via timer.

Shortest interval = 0 minutes between analyses. Largest interval = 99 minutes.

The analysis interval (interval between two analyses) is determined by the set flush time, the programmed interval and the analysis duration. The analysis duration depends **directly** on the measured value.

Selecting the time control

TIME-CONTROLLED	*
Volume interval	

- In the menu, select => BASIC PROGRAM, => MODE OF OPERAT.
=> TIME CONTROLLED
- Press "ENTER" to confirm the selection
(An asterisk " * " appears at the end of the line)
("TIME CONTROLLED" " * " is preset)

Setting the analysis interval (interval pause)

If the analysis is triggered via a timer, the interval between two analyses is determined by the interval pause (plus flushing time). The shortest interval pause can be 0 minutes. In this case, analyses are carried out continuously. The longest interval is 99 minutes.

TIME	10m
Volume	00001

- In the menu, select => BASIC PROGRAM => INTERVAL => TIME
- Use the cursor keys to select the interval in minutes (10 minutes are preset)
- Press "ENTER" to complete all the entries

NOTE

Duration of the analysis interval

- The analysis interval is the addition of the "analysis interval", the "flushing time" and the measuring value-dependent analysis duration (see diagram on the left)

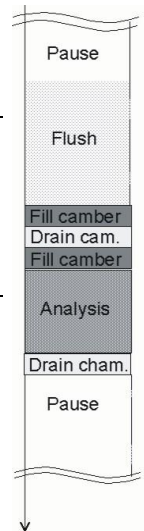

Selecting the quantity control

Minimum interval = 1 litre, maximum interval = 9999 litres. The analysis is carried out once the programmed water quantity has been measured. The line and the measuring chamber are flushed prior to the analysis (observe the programmed flush times).

Quantity control
Start via water meter

Time-controlled	
VOLUME INTERVAL	*

Time	10m
VOLUME	03501

- In the menu, select => BASIC PROGRAM => INTERVAL => VOLUME
- Press "ENTER" to confirm the selection
- Enter the respective flow rate in litres
- Press "ENTER" to confirm the entry

1 L/IMPULSE	
2,5 L/impulse	
5 L/impulse	
10 L/impulse	
100 L/impulse	*
500 L/impulse	
1000 L/impulse	
Imp/L	000.0

Selecting the type of water meter

It is necessary to connect a water meter to **input IN** for quantity-dependent analysis triggering.

- Select the menu => BASIC PROGRAM => WATER METER
- Select the water meter constant (litre/impulse) (100 litres/impulse " * " is factory set)
- Or enter the reciprocal value in Imp/l in the last field when using a turbine with a high impulse number
- Press "ENTER" to confirm the selection/entry

**Quantity control /
Time priority**

TIME-CONTROLLED	*
VOLUME INTERVALL	*

TIME	10m
VOLUME	03501

Selecting the quantity control/time priority

The analysis is carried out once the programmed water quantity has been measured. An analysis is always triggered with higher priority when the programmed interval time has been reached.

Selecting the function

- The process is the same as for "Selecting the time control"
- The process is the same as for "Selecting the quantity control"
- Press "ENTER" to confirm all the entries

Selecting the display unit

DISPLAY °dH	
Display °f	
Disp. ppmCaCO ₃	
Display mmol/l	*

It is possible to program the unit of the displayed value. The units dH, °f, ppm CaCO₃ and mmol/l can be selected. All the following inputs and displays will then be displayed in the programmed unit.

- In the menu, select =>BASIC PROGRAM=> DISPLAY OF UNIT
- Select the desired unit
(mmol/l is factory set)
- Press "ENTER" to confirm the selection

Entering the flushing time

To ensure that the analysed sample represents the current value, the sampling line must be sufficiently flushed. If the plant has been out of operation for a longer period or in case of long analysis intervals, we recommend you to select a flushing time greater than 60 seconds. Flushing starts by simultaneously opening the inlet and the outlet valve of Testomat ECO® C.

NOTE

Duration of the analysis interval

- The analysis interval depends directly on the programmed flushing time. If, e.g., a flushing time of 90 seconds has been set, the actual analysis interval cannot be less than 90 seconds.

FLUSH	00s

Entering the flushing time

- In the menu, select => BASIC PROGRAM=> FLUSH TIME => FLUSH
- Enter the time in seconds (s) in the menu item "FLUSH"
(00 seconds (s) is preset)
- Press "ENTER" to complete all the entries

Limit value monitoring

Monitoring of two limit values

It is possible to program the limit values on a continuous scale. The limit value range depends on the used indicator type and the programmed unit.

For the duration and duration/inverse switch functions, limit 1 is the upper limit and limit 2 is the lower limit. Limit 1 switches relay output 1 and limit 2 switches relay output 2.

For the two-point/inverse switch function, limits 3 and 4 are also required. Limit 3 is below limit 2, limit 4 is above limit 1 and defines an allowable range. If the reading is within this range, the LEDs LV1 and LV2 green. If it is outside the scope, both LEDs are red.

Relay output 1 is switched with limits 1 and 2.

LV 1:	1.8 mmol
LV 2:	1.2 mmol
LV 3:	0,8 mmol
LV 4:	2,0 mmol

Entering the limit values

- In the menu, select =>BASIC PROGRAM=> LIMIT VALUES
- Enter the values for "LV 1" or "LV 2"
- Press "ENTER" to confirm the entry

Hysteresis

The respective limit value output only switches after the first, second or third bad analysis (suppression of the first or the second measured value). This increases the reliability of the analysis evaluation, e.g. if the sampling line has not been flushed sufficiently. The hystereses of the two outputs LV1 and LV2 can be set independently of each other. With a hysteresis of "2", the next analysis is immediately carried out when the limit value of this analysis has been exceeded for the first time. The respective output is only switched after the limit value of this analysis has been exceeded for a second time. With a hysteresis of "3", the respective output only switches when the limit value of this analysis has been exceeded for a third time. This setting is only reactivated once the value has fallen below the limit value!

(The basic setting for LV1 and LV2 is 1)

HYSTERESIS LV1	1
----------------	---

HYSTERESIS LV2	1
----------------	---

- In the menu, select => BASIC MENU
=> HYSTERESIS LV1 or HYSTERESIS LV2
- Enter the number of analyses
- Press "ENTER" to confirm the entry

Switch functions of the limit value outputs LV1 and LV2

The description of the possible limit displays for these switching functions can be found on page 19.

Switch function duration

If the limit value LV1 or LV2 has been exceeded, the output relay LV1 or LV2 switches. If the measured value falls below the limit value LV1 or LV2, the relevant relay drops out again.

Switch functions diagram

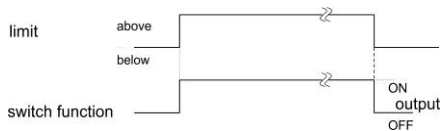

Switch function duration/inverse

If limits LV1 or LV2 are not exceeded, output relay LV1 or LV2 is switched. If the limit is exceeded, the relay drops out again.

Two point switching function:

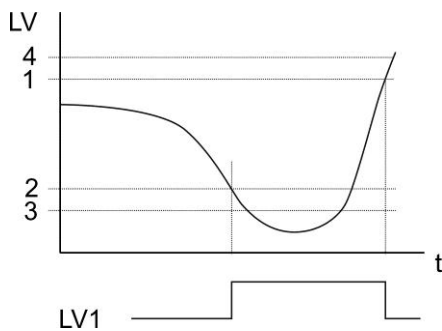

Switch function two-point/inverse

If limit 2 is not exceeded, then output relay LV1 switches. If limit 1 is exceeded, relay LV1 drops out.

Limits 3 and 4 are available for this function. With their help, exceeding or not exceeding this range is displayed between these two limits.

Selecting the functions

- In the menu, select => BASIC PROGRAM => FUNCTION LV1 or FUNCTION LV2
- Select the duration, duration/inverse or two-point/inverse (only for LV1)
(An asterisk " * " appears at the end of the line)
- Press "ENTER" to confirm the entry

DURATION	*
Duration/inverse	
Two point/inverse	

Description of the signal inputs/outputs

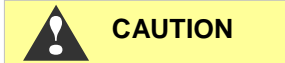

CAUTION

Connecting the signal inputs

- Only connect the signal inputs "Stop" and "IN" with *volt-free* contacts!

The connection of external voltages would damage the instrument!

Stop input

Stop
Terminals 18,19

Function	Contact type	Test time	Action
Stop External analysis stop (e.g. via flow controller or process controller)	Programmable: Normally closed or normally open	None	As long as the contact at the input is 'open' or 'closed', no analyses are carried out

An active Stop input prevents an analysis start, e.g. via a current interval. This can be necessary if the plant does not supply water. A current analysis is stopped when the input valve is opened (while the measuring chamber is being flushed or filled). The water which has already entered the measuring chamber remains there. If the measuring chamber is already full, the analysis is executed. Manual start has priority over the Stop input, i.e. if the Stop input is active, an analysis can be started manually or a manually started analysis cannot be stopped by the stop signal. In the operating mode "time-controlled", the interval time continues when the Stop input has been activated.

As long as the Stop signal is present, "STANDBY" is displayed alternatively to the measured value.

NORM. CLOSED CON
Norm. open cont. *

Programming the switch function "Stop input"

- In the menu, select => BASIC PROGRAM => FUNCTION STOP
- Select the type of contact
- Press "ENTER" to confirm the selection

Water meter input

IN
Terminals 20,21

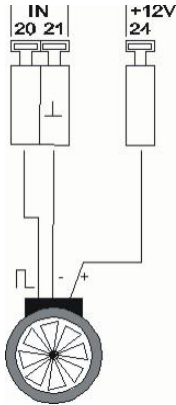

1 L/IMPULSE
2,5 L/impulse
5 L/impulse
10 L/impulse
100 L/impulse *
500 L/impulse
1000 L/impulse
Imp/L 000.0

Function	Contact type	Test time	Action
IN Water meter input	normally open/normally closed or turbine (isolated!)	None	Quantity recording for starting an analysis

Connecting a turbine

Besides the connections 20 and 21, an additional power supply is required for connecting a turbine. Connect this power supply (+ 12 V) to terminal 24.

The connection configuration is shown in the diagram on the left.

Programming the water meter input

- WIn the menu, select => BASIC PROGRAM=> WATER METER
- Select the meter constant of the water meter
- Press "ENTER" to confirm the selection

Or when using a turbine

- Select "Imp/L"
- Enter the rating of the turbine
(ranges from 1 to 999.9 impulses/litre)
- Press "ENTER" to confirm the entry

Current interface 0/4 - 20 mA

OUT
Terminals 22,23

Function	Connection	Action
OUT Current interface 0/4 - 20 mA	max. load 500 Ohms	programmable: 0 - 20 mA or 4 - 20 mA

NOTE

Current interface load

- The maximum load of 500 Ohms should not be exceeded!
In case of possible faults and when using very long cables (approx. 20 m), a screened cable should be used, if possible.

Example Reagent TH 2100, Interface 0 - 20 mA

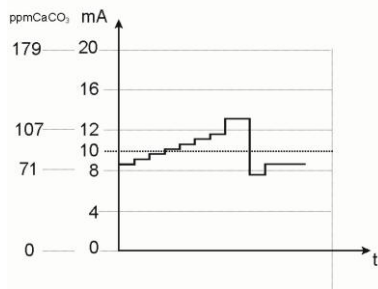

Type 0 - 20 mA
Type 4 - 20 mA *

Monitoring the measuring point

A printer can be connected to record the analysis results. The instrument is equipped with a programmable current output for this purpose (optional 0-20 mA or 4-20 mA).

The example on the left displays the current profile in the 0-20 mA range.

- In the menu, select => BASIC PROGRAM => INTERFACE
- Select the desired current range
- Press "ENTER" to confirm the selection

How is the current calculated for a certain measured value?

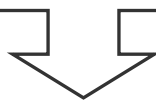

Function
0 - 20 mA

$$\text{Current} = \frac{\text{Measured value}}{\text{Maximum value}} \times 20 \text{ mA}$$

Function
4 - 20 mA

$$\text{Current} = \frac{\text{Measured value}}{\text{Maximum value}} \times 16 \text{ mA} + 4 \text{ mA}$$

Measuring range not reached (e.g. <0,5 °dH)

The current is set to 0 or 4 mA.

Measuring range exceeded (e.g. >10,0 °dH)

The current is set to 20 mA.

Measured value = Value displayed in the selected hardness unit

Maximum value = Final value of the used indicator
(e.g. indicator type TC2050 = 10,0 °dH)

Description of the relay outputs

All relay outputs are neutral contacts. This ensures that all connection options are available. The switching of mains voltage and external voltage, and the direct switching of inputs, e.g. a process controller, can be realised.

LV1 and LV2 limit value outputs

Two potential-free relay contacts are available for reporting the exceeding or non-exceeding of the limit and for a two-point controlling function. The limits, hysteresis and switch function are separately programmable for both contacts:

Limit value 1 Terminals 9,10,11

Function	Contact	Action
LV1 Relay switches according to the selected switching function under <code>FUNCTION LV1</code> .	Volt-free change-over contact	Further basic program data: <ul style="list-style-type: none"> - Limits - Hysteresis LV1

Limit value 2 Terminals 12,13,14

Function	Contact	Action
LV2 Relay switches according to the selected switching function under <code>FUNCTION LV2</code> .	Volt-free change-over contact	Further basic program data: <ul style="list-style-type: none"> - Limits - Hysteresis LV2

For a detailed description and programming refer to the section entitled "Switch functions of the limit value outputs LV1 and LV2"!

Alarm/Message (fault message output)

The instrument is equipped with an ALARM relay output for signalling faults. The fault message is displayed via the fault LED and on the display.

NOTE

Alarm

Terminals 15,16,17

The following faults activate the "Alarm" output and are displayed:

Low water pressure
Function fault optics
Function fault dosing pump
Function fault drain outlet

Low indicator level
Function fault soiling
Measuring fault turbid
Measuring range exceeded
Indicator level

Error messages

- The error message can only be deleted once the error has been eliminated!

The "Alarm" output is a volt-free change-over relay contact. During trouble-free operation the contact between the terminals 16 – 17 is closed and the one between terminals 15 -16 is open. In case of a voltage breakdown, the contact between the terminals 15 – 16 is closed and the one between terminals 16 – 17 is open.

The instrument is equipped with a range of monitoring functions with the following functions/behaviour of the "Alarm" output:

- With a continuous contact, the "Alarm" output remains activated (terminals 15 – 16 closed) as long as the fault persists.
- The red LED "Alarm" and the text on the display indicate a fault.
- The fault message signal at the "Alarm" output is deleted by confirming the fault via the "Horn" key.
- The error message can only be deleted if the fault has been eliminated.
- Exception: "Indicator level", this message is confirmed in the M menu under Service by entering the new indicator filling level.
- There is **no** additional alarm via the fault message output when the limit value is exceeded!

The error messages are described under "Error messages / Troubleshooting"

A description of the possible causes of malfunctioning can be found in the section entitled "Error messages / Troubleshooting".

Information menu "i"

Request current settings and statuses of the instrument in the Information menu.

Call (1)

Use the  key to open the information menu "i".

Call (1)

Opening the information menu for checking or requesting settings and operating values.

Request options: Operating values, program values

Selection (2)

- Operating values or
- Program values

Operating values (3)

- Display of the current values:
- Indicator filling level
 - Software version

Program values (4)

Use the arrow keys to open the menu item "Program values". Press the "ENTER" key to open the list of the set values. Press the "ENTER" key to request the current setting of a parameter => (4a)

An asterisk indicates the selected functions. (There are no active lines.)

Selection of the program value (4a)

Display of the programmed indicator type and its hardness range.

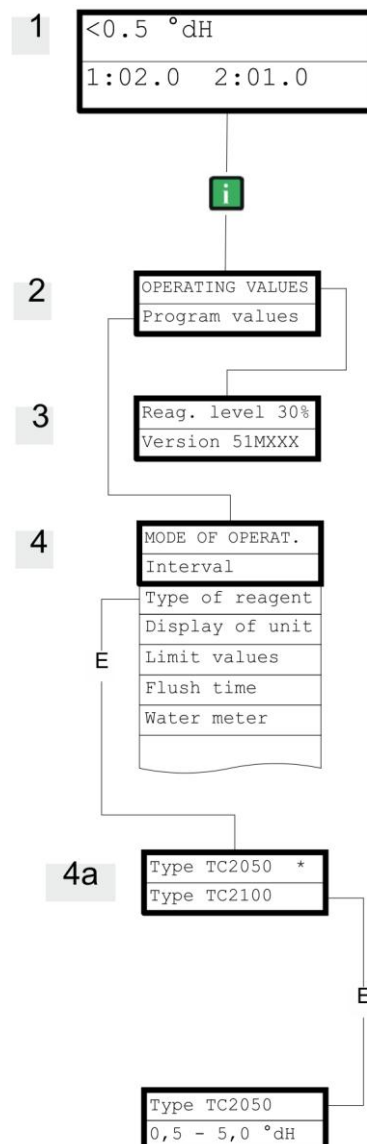

Please refer to the section entitled "Entering basic program data" for further programming and setting details of the individual menu items".

Program menu "M"

Call (1)

Use the **M** key to open the program menu "M".

Programming of: Indicator, manual operation, flush, flush chamber, drain chamber, fill chamber, language, diagnosis

Service (2)

Input indicator (3)

Enter the new filling levels after each refill or indicator bottle change. Once you have selected the menu item for entering the filling level "Indicator filling (0 - 100%)" via the "ENTER" key, the value is preset to 100%. If you have connected a full bottle, press "ENTER" to confirm the value. If the filling level of the bottle differs, enter the corresponding value.

Manual operation (4)

After confirming the information message (4) via the "ENTER" key, it is possible to select and activate the desired function by using the arrow keys and pressing the "ENTER" key. These functions are used for checking the functions and for commissioning.

Flush (5)

Press the "ENTER" key to start the flushing of the sampling line via the internal valves. Press the "ENTER" key again to cancel this function.

Flush chamber (6)

Press the "ENTER" key to flush the measuring chamber once.

Drain chamber (7)

Press the "ENTER" key to open the outlet valve in order to drain the water from the measuring chamber. Press the "ENTER" key again to cancel this function.

Fill chamber (8)

Press the "ENTER" key to fill the measuring chamber.

NOTE

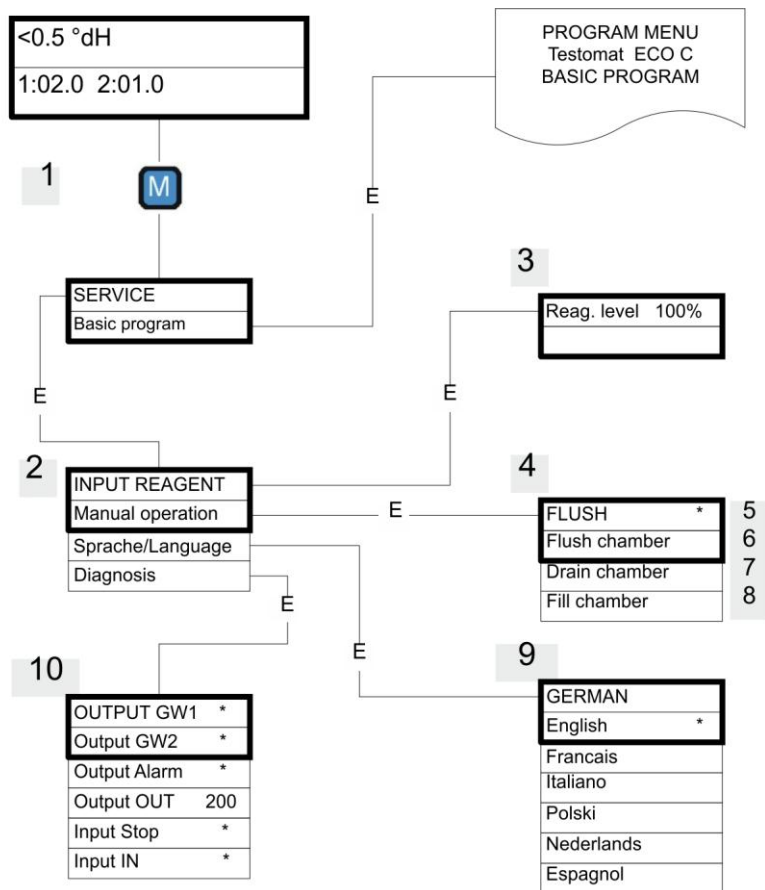

Availability of functions

- All manual functions can only be selected during an analysis pause. Analyses are not carried out during manual operation. All signal inputs and outputs are locked.

GERMAN
English *
Francais
Italiano
Polski
Nederlands
Espanol

Language (9)

Select the desired language for the display.

Diagnosis (10)

It is possible to request a list of current statuses of the signal inputs and outputs. Active statuses are marked with an *. (See "Structure of the basic program").

The current interface can be checked under "OUT output". Press the "Enter" key to toggle between minimum and maximum current.

Changeover occurs between 000 and 200 at 0-20 mA!

Basic program

Access this menu item by pressing the "M" key (menu). Here you can carry out basic programming of the instrument and select various service functions.

In the basic program, the following abbreviations are used in the respective menu items:

s = seconds; m = minutes; h = hours; T = days; l = litres

Structure of the basic program

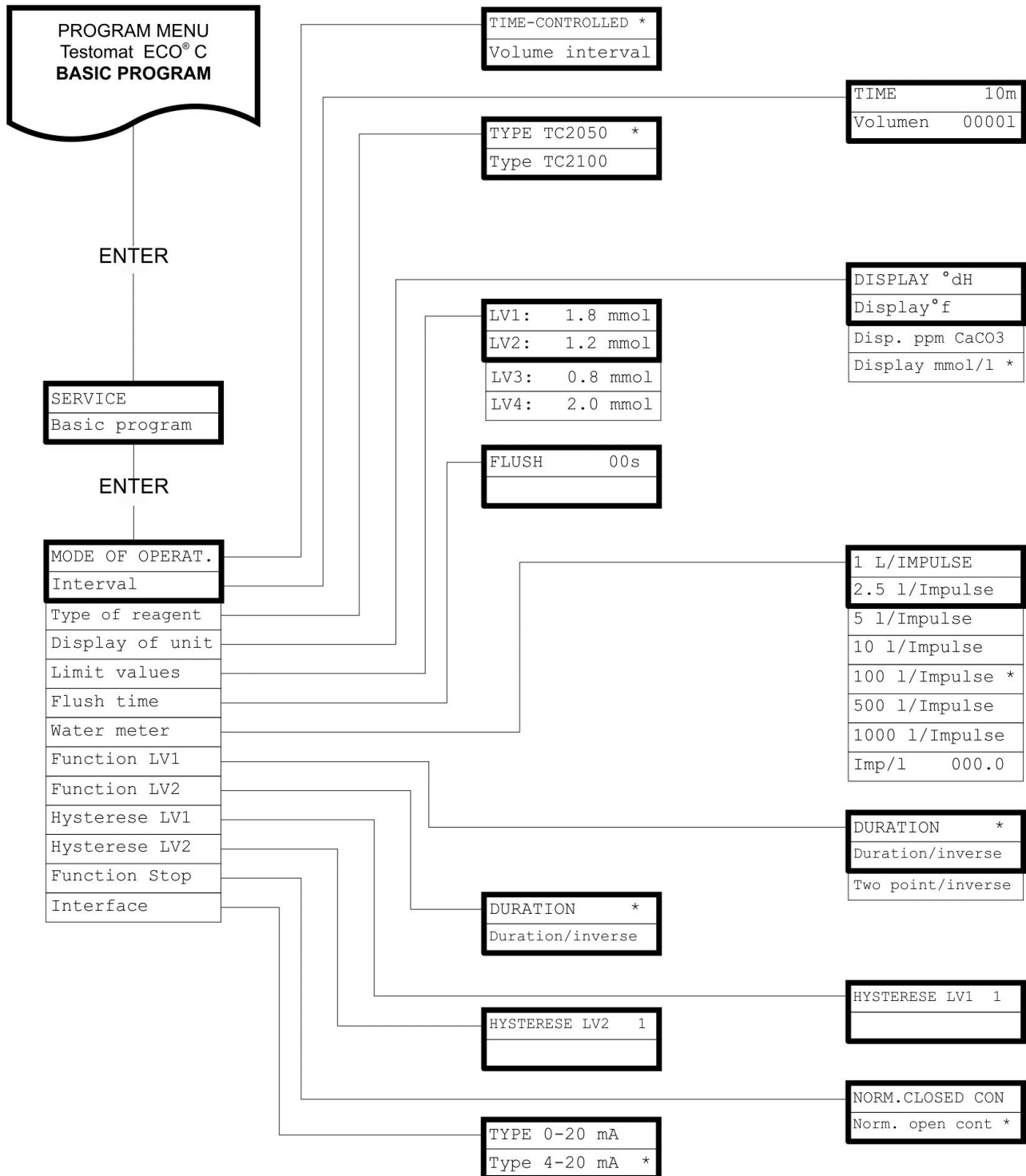

Call the basic factory program by simultaneously pressing and holding down the "M" and "i" keys while switching on the instrument. CAUTION, the most recent programming will be lost!

Error messages/Troubleshooting

Displayed message (flashes at selected display)	Instrument result functions	Possible causes	Remedies
Ff. DOSING PUMP ➤ CANCEL WITH HORN KEY	- Continuous alarm - Standby	- Dosing pump is defective - No dosing message from the dosing pump	➤ Replace dosing pump ➤ Check cable to the dosing pump for correct connection
MSt. TURBID ➤ CANCEL WITH HORN KEY	- Continuous alarm - Continue measurements	- The water is turbid / soiled	
MEASURING RANGE EXCEEDED ➤ CANCEL WITH HORN KEY	- Continuous alarm - Continue measurements	- The measuring range has been exceeded	➤ Select another type of indicator (basic program)
LOW WATER LEVEL ➤ CANCEL WITH HORN KEY	- Continuous alarm - Standby	- no water input - Inlet pressure too low - Overflow detection does not react	➤ Check water inlet ➤ Connector at the inlet valve oxidised ➤ Clean filter strainer ➤ Replace valve block Extract pressure controller valve body
Ff. OUTLET TO DRAIN ➤ CANCEL WITH HORN KEY	- Continuous alarm - Standby	- Water remains in the measuring chamber	➤ Check water outlet ➤ Connector at the outlet valve oxidised ➤ Replace valve block
LOW INDICATOR LEVEL ➤ CANCEL WITH HORN KEY	- Continuous alarm - Cancel measurement and go into standby	- No indicator is getting to the measuring chamber.	➤ Check dosing pump (see page 37) ➤ Check suction pipe in the indicator bottle ➤ Check tubes on suction and pressure side for damage. ➤ Check if the screwed connections are leaking or if air is in the pipes. ➤ Check that the stirring bar is turning.
Mf. SOILING ➤ CANCEL WITH HORN KEY	- Continuous alarm - Continue measurements	- Sight-glass windows are soiled	➤ Clean sight-glass windows
Ff. OPTICS ➤ CANCEL WITH HORN KEY	- Continuous alarm - Standby	- Error at the optical component (transmitter or receiver defective)	➤ Replace the measuring chamber holder
INDICATOR LEVEL CANCEL WITH HORN KEY	- Continuous alarm - Continue measurements	- Minimum indicator quantity not reached: 10 %	➤ Check the level of the indicator and refill it if necessary. Then enter the new level under: „REAG. LEVEL“ in M menu. ➤ Check that the stirring bar is turning.
Abbreviations: Ff.: = Function fault, Mf.: = Measuring fault			

Further information

Error	Possible causes	Remedies
Current interface functions incorrectly	- Incorrect measured value at the output or no power supplied	➤ Load too high
Unit is not functioning, even though it is switched on No display	- Fuse F8, F4 or F9 (240 V: F1) defective - Power switch defective - Ribbon cable at control circuit board or base circuit board is loose - Error at control circuit board or base circuit board	➤ Replace fuses ➤ Replace power switch ➤ Reconnect ribbon cable ➤ Replace control or base circuit board

Checking the dosing pump

Proceed as follows to check correct functioning and the dosing quantity of the dosing pump:

- Press the "STANBY" key
"STANDBY" is displayed.
- Make sure that the measuring chamber is empty.
- Remove the pressure hose from the measuring chamber holder.
- Subsequently press the "manual" key on the dosing pump.
- The dosing quantity must be a single drop (30 µl) and should drip from the pressure hose
- Collect the indicator in a container!

Maintenance

NOTE

Required maintenance measures

- Regular maintenance is necessary to ensure trouble-free operation of the instrument!

Please regularly carry out the maintenance work described in the following section when

- the instrument displays the following error messages:
"Mf. soiling" or "Low indicator level"

the last maintenance was carried out max. 6 months ago

Description of maintenance work

The maintenance manual contains a detailed description of maintenance work. The measures described here provide a brief overview. Please refer to the Testomat 2000[®]/Testomat ECO[®] maintenance manual for all further maintenance details.



CAUTION

Cleaning measures

- Never use organic solvents to clean the measuring chamber or other plastic parts!
- Please observe the safety regulations when handling cleaning agents!
- If the measuring range of the instrument is exceeded over a longer period of time, a coloured film may form on the sight-glass windows. Use isopropanol to remove this sticky film.

Cleaning the measuring chamber and sight-glass windows

- Switch off the instrument or press the "STANDBY" key (measuring chamber completely drained?).
- Close the manually-operated valve of the branch line to Testomat ECO[®] C.
- Unhook the toggle type fastener, tip the measuring chamber upwards and remove it.
- Release both sight-glass window holders, remove and clean the sight-glass windows.
- Use isopropanol to remove the film on the sight-glass windows.
- Clean the measuring chamber with 10 % hydrochloric acid and then rinse well.
- After cleaning, re-insert the sight-glass windows and secure them with the sight-glass window holders
(Do not forget the O-ring seals and ensure correct fitting in the groove).

- Insert the measuring chamber by tilting it backwards and secure it using the toggle type fastener.

**CAUTION****Removal and installation of the sight glass windows**

Ensure tension-free mounting of the sight glass windows. Tighten the screws equally alternating both sides. Otherwise, the sight glass windows may break.

**Cleaning the filter housing**

- Close the manually-operated valve of the branch line to Testomat ECO® C.
- Depressurise the lines of Testomat ECO® C via the "Flush" function in MANUAL MODE.
- Switch of the instrument and loosen the hose connections at the filter housing.
- Unscrew the inlet connection and remove and clean the seal, the spring and the filter.
- Extract the retaining pin and withdraw the flow controller and finally remove the flow controller valve body.
- Clean the filter housing with water or alcohol and reassemble the unit.
- Insert the filter strainer with the cone facing downwards!
- Reattach the hose connections at the filter housing.

**CAUTION****Important maintenance information**

Water leakage at sealed points can damage parts of the instrument! Please check the instrument for leaks prior to the first analysis:

- Switch the instrument to STANDBY
- Manually fill the measuring chamber
- Manually dose the indicator ("Manual" key")
- Check the connections and seals for leaks

Service instructions

The surface of the instrument has not been treated. Therefore, soiling caused by indicators, oil or grease should be avoided. However, if the housing becomes soiled, please clean the surface with isopropanol (never use other solvents).

Testomat ECO® C spare parts and accessories

Art. No.	Pressure controller
40125	Controller / filter receiver, complete
40120	Controller / filter receiver
40129	Controller plug T2000, complete
11225	Flow controller valve body, complete
11230	Retaining pin 3x38 90°
11217	Inlet filter 19.5dx25
11218	Spring for inlet filter
40121	Inlet connector
40153	Plug in connector G 1/4" -6
40157	Angled plug-in connector G 1/8"
Measuring chamber	
40173	Sight-glass window with seal, T2000
40170	Sight-glass window 30x3
40176	Sight-glass holder, countersunk and thread
33253	Screw M3x40, A2, DIN 965
40032	Latch fastener TL-17-201-52
11210	Plug for measuring chamber T2000/Eco
40022	Measuring chamber T2000, complete
Measuring chamber holder	
40377	Measuring chamber holder T2000, blue/yellow
40050	Magnetic stirrer, processed
40156	Srew in connector 3/8" -10, processed
40018	Solenoid valve, 2/2-way
Dosing pump DosiClip®	
40001	Dosing pump DosiClip SP
40011	Suction hose, complete
40016	Pressure hose, complete
40040	Valve set
32046	Plastic cover CNH 45 N
Bottle connection / Suction device	
40131	Screw cap with bottle insert T2000
40130	Screw cap GL32 - hole
40135	Bottle insert for screw cap with push-fit suction tube

Art. No.	Instrument spare parts list
31582	Fuse GS-M 5x20E 4A
37245	Basic circuit board T-ECO complete 230 V
40332	Control circuit board T-ECO complete
40091	Plug in circuit board driver/receiver SE-T2000 (6)
40190	Cable sleeve 5-7, grey
40191	Cable sleeve 7-10, grey
31713	Ribbon cable 10 pole with EMI filter clamp
40096	Ribbon cable 26 pole with EMI filter clamp
40060	Cable loom 2V for T2000
40062	Cable loom 2P for T2000
40200	Cable loom complete with power switch and cover
31622	Fuse, soldered T0.16A
31592	Fuse, soldered T1.016A
Spare parts requirement for 2 - 3 years of operation	
40173	Sight-glass window with seal, T2000
11217	Inlet filter 19.5dx25
40124	Gasket set T2000
31622	Fuse, soldered T0.16A
31592	Fuse, soldered T1.016A

Accessories

Indicator type	Range	Art. no.:
TC2050*	Carbonate hardness 0,18 – 3,58 mmol/l	153050
TC2100	Carbonate hardness 0,36 - 7,16 mmol/l	153100

* extended measuring range

Please refer to our delivery programme for an up-to-date overview of available accessories.

Art. no.	Description
040123	Retrofit kit for water inlet T2000 *)
270337	Maintenance lab T2000 Heyl

***) retrofit kit for water inlet, Art. no. 040123**

If fabric-reinforced pressure hoses (e.g. for existing installations) are used, please replace the plug connector at the controller and filter housing with a plug for the quick-release coupling (not included).

Technical data

Power supply:	230 VAC, 115 VAC or 24 VAC \pm 10%, 50 - 60 Hz Fuse 230 V: T0.16 A Fuse 115 V: T0.315 A Fuse 24 V: T1.0 A
Power consumption:	max. 25 VA, without external load
Protection class:	I
Degree of protection:	IP 65
Conformity:	EN 61000-6-2, EN 61000-6-4, EN 61010-1 
Ambient temperature:	10 – 45°C
Measuring range:	See section "Performance specifications"
Current interface:	0/4 - 20 mA, max. load 500 Ohm
Dimensions:	W x H x D = 380 x 480 x 280 mm
Weight:	Approx. 9.0 kg
Others:	The unit is non volatile

Mains water supply	
Operating pressure:	1 to 8 bar / 1×10^5 to 8×10^5 Pa or 0.3* to 1 bar / 0.3×10^5 to 1×10^5 Pa (after removing the valve body)
Water inlet:	Opaque pressure hose with an external diameter of 6/4x1 mm
Water outlet:	Hose with an internal diameter of 12 mm
Water temperature:	10 – 40 °C

* When using Testomat ECO[®] C at a pre-pressure of 0.3 bar, it must be ensured that the flow rate through the measuring chamber is at least 400 ml/min.

We reserve the right to make technical changes without notice in the interest of constantly improving our products!
Our manuals are updated regularly. If you have an older version (see version at the back of the manual) you will find the current manual on our website www.heyl.de on the download page.

Conformity Declaration

EC Conformity Declaration



for the following product

Testomat ECO C
Online analysis instrument for carbonate hardness

We hereby confirm that the above product conforms to the principal health and safety regulations laid down in the EC Directives 2004/108/EG and 2006/95/EG. This declaration applies to all units produced in accordance with the attached manufacturing documents which are a constituent part of this declaration.

The product was assessed with reference to the following standards:

EN 61000-6-4: Electromagnetic compatibility, Generic emission standard
EN 61000-6-2: Electromagnetic compatibility, Generic immunity standard
EN 61010-1: Safety requirements for electrical equipment for measurement, control and laboratory use

This declaration is made on behalf of

GEBRÜDER HEYL
Analysentechnik GmbH & Co. KG
Orleansstraße 75b
31135 Hildesheim

by

Jörg-Tilman Heyl
General Manager

Hildesheim, 01/02/2016

Check List Testomat ECO[®] C

Dear customers and service technicians,

This check list cannot replace your expertise or extensive experience in fault resolution. It is intended to support fast and systematic error diagnosis and error documentation. This list does not claim to be complete. We are therefore always grateful for any advice and information you may be able to provide. General user instructions can be found on the rear of this check list.

The Instrument Manufacturer

Block 1 / Plant and instrument data

		Testomat ECO C				
Plant type		Instrument type	Instrument no.	Indicator type	Software status	Pump no.

Block 2 / Error message and error history Please mark appropriately (X)

What does your instrument's error history display? (“i” and “Enter” key => operating instructions)					(Error history text)
Does an error message appear on the display? For example, “Low water level”, etc. (See operating instructions: “Error messages / Troubleshooting”)	Yes	No			(Error message text)

Block 3 / Visual inspection and functional test Please mark appropriately (X) If applicable, values / comments

Is the instrument connected to the mains voltage specified on the rating plate?	Yes	No	
Does a message appear on the display?	Yes	No	
Does the instrument display a plausible measured value? (possible manual measurement _____ value)	Yes	No	Measured value:
Are the measuring chamber and sight-glass windows clean?	Yes	No	
Are the measuring chamber and the water-carrying hoses free of leaks?	Yes	No	
Is the indicator's expiry date still valid? (See expiry date printed on the indicator bottle)	Yes	No	Expiry date:
Has the correct indicator type been programmed? (TC 2050 => factory setting)	Yes	No	Type:
Is the water pressure within the specified range (400 ml/min)? (See the type plate on the instrument)	Yes	No	Plant pressure:
Does the drain hose prevent the risk of backwater? (No “syphoning effect”!!)	Yes	No	
Is the drain hose free of blockages? (Microorganisms caused by contamination, etc.)	Yes	No	
Does the set flushing time/quantity of flush water ensure that only freshwater is measured?	Yes	No	Flushing time:
Are the hoses at the dosing pump free from air bubbles? (Operate the pump manually / Carry out a manual analysis)	Yes	No	

CARRYING OUT A (MANUAL) ANALYSIS

Does the water column rise evenly up to the overflow borehole when filling the measuring chamber (5 mm below the upper edge of the measuring chamber)? (If not: check the water pressure, water throughput/flow controller)	Yes	No	
Does the indicator pump dose correctly when starting an analysis? (LED at the pump illuminates!)	Yes	No	No. of dosing strokes:
Have the indicator and water been mixed properly in the measuring chamber after the dosing process? Check the magnetic stirring bar! =>see maintenance manual “Adjust mode”	Yes	No	

PROGRAMMING DATA / OPERATING CONDITIONS

Have the limit values been set correctly? (Within the measuring range/according to the performance limit of the plant?)	Yes	No	Limit values:
Is the Testomat instrument always supplied with mains voltage – except during maintenance work/emergency situations? (Temporary shutdown only via the “Standby” key or the “Stop” input!)	Yes	No	See the “General instructions for operating Testomat 2000 [®] and Testomat [®] ECO”

Please refer to “Error messages / Troubleshooting” in the **operating instructions** for further information on error messages and possible causes of faults.

Further functional tests (e.g. overflow detection and amplification setting => “Special function Adjust mode”) and service instructions can be found in the **maintenance manual**.

After completing these checks, experience shows that it can be assumed that the checked functions (Block 3) are in effective working order if you have answered all the questions with “Yes”. We recommend you to carry out these checks during each inspection or if faults occur.

Instrument settings

Caution!

Your settings may be deleted if repairs are carried out. Therefore, note down your instrument settings in the table below before sending the instrument to our service team for repairs. Please enclose a copy of the table with the instrument. If you have noted down the settings, they can be easily re-entered by your service staff once any repairs have been completed.

Menu	Setting
MODE OF OPERATION	
Time-controlled	
Volume interval	
DISPLAY UNIT	
Display in °dH	
Display in °f	
Display in ppm CaCO ₃	
Display in mmol/l	
TYPE OF REAGENT	
Type TC2050	
Type TC2100	
LIMIT VALUES	
Limit val. 1:	
Limit val. 2:	
Limit val. 3:	
Limit val. 4:	
FLUSH TIMES	
Flush	
TYPE OF WATER METER	
1 Litre/Impulse	
2,5 Litres/Impulse	
5 Litres/Impulse	
10 Litres/Impulse	
100 Litres/Impulse	
500 Litres/Impulse	
1000 Litres/Impulse	
FUNCTION LV1	
Duration	
Duration/inverse	
Two point/inverse	
FUNCTION LV2	
Duration	
Duration/inverse	
HYSTERESIS LV1	
Analysis (1,2,3)	
HYSTERESIS LV2	
Analysis (1,2,3)	
FUNCTION STOP	
Normally open contact	
Normally closed contact	
INTERFACES	
Type 0-20 mA	
Type 4-20 mA	

SPRACHE/LANGUAGE	
DEUTSCH	
English	
Français	
Italiano	
Polski	
Nederlands	
Espanol	

Product overview Testomat 2000®-Instruments



Model/Type	Measuring Parameter	Measuring Range	Applications/Functions
Testomat 2000®	<ul style="list-style-type: none"> • Water hardness • Carbonate hardness • p-value • minus-m-value 	0.05-25 °dH 0,5-20 °dH 1-15 mmol/l 0.05-0.5 mmol/l	<ul style="list-style-type: none"> • Universal for water treatment plants • allowed for boiler houses
Testomat 2000® Antox	as Testomat 2000®	as Testomat 2000®	<ul style="list-style-type: none"> • dosing a reducing agent
Testomat 2000® CAL	as Testomat 2000®	as Testomat 2000®	<ul style="list-style-type: none"> • Automatic calibration function
Testomat 2000® CLF	<ul style="list-style-type: none"> • Free Chlorine 	0-2.5 mg/l	<ul style="list-style-type: none"> • DPD-method for swimming pool and drinking water control
Testomat 2000® CLT	<ul style="list-style-type: none"> • Total Chlorine 	0-2.5 mg/l	<ul style="list-style-type: none"> • DPD-method for swimming pool and drinking water control
Testomat 2000® CrVI	<ul style="list-style-type: none"> • Chromate • Chrome-VI 	0-2.0 mg/l 0-1.0 mg/l	<ul style="list-style-type: none"> • process control of waste water in galvanic industry
Testomat 2000® Duo	as Testomat 2000®	as Testomat 2000®	<ul style="list-style-type: none"> • Controlling of two measuring points
Testomat 2000® Fe	<ul style="list-style-type: none"> • Iron-II and Iron-III 	0-1.0 mg/l	<ul style="list-style-type: none"> • De-Ironing plants
Testomat 2000® Polymer	<ul style="list-style-type: none"> • Polyacrylate 	0-50 mg/l	<ul style="list-style-type: none"> • Monitoring of conditioning agents in the cooling and heating cycles
Testomat 2000® SO₃	<ul style="list-style-type: none"> • Sulphite 	0-20 mg/l	<ul style="list-style-type: none"> • Control of the Oxygen-binding by Sulphite in boiler feed water
Testomat 2000® self clean	as Testomat 2000®	as Testomat 2000®	<ul style="list-style-type: none"> • Automatic cleaning of the measuring chamber
Testomat 2000 THCL®	<ul style="list-style-type: none"> • Total Chlorine • Water hardness 	0-2.5 mg/l 0.25-2.5 °dH	<ul style="list-style-type: none"> • DPD-method for swimming pool and drinking water control • combination system for hardness and chlorine
Testomat 2000® V	<ul style="list-style-type: none"> • Water hardness • Carbonate hardness 	1.0-25.0 °dH 1.0-20.0 °dH	<ul style="list-style-type: none"> • blending water

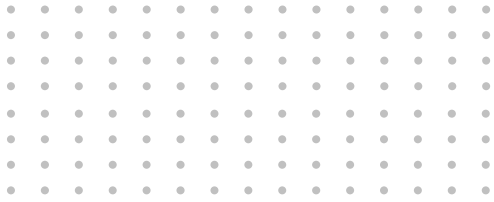

Gebrüder Heyl
Analysentechnik GmbH & Co. KG
Orleansstraße 75b
D 31135 Hildesheim
www.heyhl.de

Testomat_ECO_C_GB_190311.doc



Scan the code and
visit us on our website!