

Service Instructions



Testomat[®] EVO TH



These operating instructions are the copyrighted property of Heyl Analysetechnik GmbH & Co. KG.

It is intended for customer service and should only be used by authorised service staff.

No part of this publication may be reproduced or transmitted in any form or by any means to a third party, in particular to our competitors, without express prior permission of Heyl Analysetechnik GmbH & Co. KG.

Contents

Contents	2
Important safety information	3
Qualification of the staff	3
Warning notices in these instructions	3
Further documents.....	4
General instructions	4
Key combinations when switching on	6
Prior to carrying out maintenance work	7
Permissible tools.....	7
Carrying out maintenance	8
Removing and installing the measuring chamber holder.....	8
Cleaning of clogged solenoid valves	9
Repairing or replacing the dosing pump	13
Replacing the dosing pump valves	14
Checking the dosing pump	14
Checking dosing	15
Special function “Adjust mode”	16
Testing of the overflow detection	16
Checking the automatic adjustment.....	17
Manual measured value check	18
Troubleshooting	19
Error message “36 Fault analysis”	19
Error message “38 Water low”	21
Error message “33 Fault optics”	22
Error message “34 Fault turbid”	22
Error due to defective hardware	22
Readjusting the current interface.....	23
Spare parts for Testomat® EVO TH	24
Component positions	25
Checklist Testomat® EVO TH	29



Important safety information

- Please read the operating instructions and maintenance instructions carefully and completely prior to carrying out maintenance work at Testomat instruments.
- Observe the warning notices in these maintenance instructions and the operating instructions of the respective instrument.
- Always adhere to hazard warnings and safety tips when using reagents, chemicals and cleaning agents. Please adhere to the respective safety data sheet! Download the safety data sheets for the supplied reagents at <http://www.heyl.de>.

Qualification of the staff

Maintenance work requires fundamental electrical and process engineering knowledge as well as knowledge of the respective technical terms. Assembly and commissioning should therefore only be carried out by a specialist or by an authorised individual supervised by a specialist.

A specialist is someone who due to his/her technical training, know-how and experience as well as knowledge of relevant regulations can assess assigned tasks, recognise potential hazards and ensure appropriate safety measures. A specialist should always adhere to the relevant technical regulations.

Warning notices in these instructions

The warning notices in these instructions warn the user about potential dangers to individuals and property resulting from incorrect handling of the instrument. The warning notices are structured as follows:



SIGNAL WORD!

Description of the type or source of danger

Description of the consequences resulting from non-observance

- Preventive measures. Always adhere to these preventive measures.
-



“**DANGER**” indicates an immediate hazardous situation which, if not avoided, will result in death or serious injury.



“**WARNING**” indicates a potentially hazardous situation which, if not avoided, could result in death or serious injury.

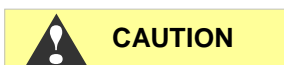

“**CAUTION**” indicates a potentially hazardous situation which, if not avoided, could result in minor or moderate injuries or property damage.



“**NOTE**” indicates important information. If this information is not observed, it may result in an undesirable result or state.

Further documents

Testomat instruments are plant components. Therefore, always observe the documentation of the plant manufacturer.

General instructions

Regular maintenance is necessary to ensure trouble-free operation of the Testomat instrument. Regular visual inspections also increase operational reliability. Also refer to the notes in the operating instructions!

NOTE

Fix errors by yourself.

Experience has shown that many errors that occur in day-to-day operations you can fix by yourself.

This ensures that the instrument is soon working again. In this maintenance manual you will find possible causes of malfunctions and helpful hints for their elimination.

Overview of maintenance work to be executed

The maintenance intervals may vary depending on the water and pipeline quality.

















Maintenance work	Quarterly	Semi-annually	Annually	Biennially / Triennially
Cleaning sight-glass windows	X			
Cleaning measuring chamber / measuring chamber holder	X			
Cleaning the receiver optics		X		
Cleaning the controller/filter housing		X		
Cleaning the waste water line	X			
Checking the dosing pump incl. suction and pressure hoses		X		
Electrical and hydraulic connections		X		
Renewing the sealing kit (40124) and sight-glass windows			X	
Recommendation: Allow the manufacturer to overhaul the dosing pump				X

- Clean the measuring chamber at regular intervals (approx. every 6 months) and, if possible, replace the two seals of the measuring chamber holder and the sight-glass windows.
- If the water has high iron content, cleaning might be necessary more often.
- Only use a dry, lint-free cloth for cleaning.
- To carry out maintenance work after the error message “35 Fault soiling” or “33.Fault optics”, always confirm the error message.
- If maintenance is carried out after an instrument maintenance message (maintenance interval), maintenance must be confirmed.
BASIC PROGRAM -> SERVICE TIME -> ACKNOWLEDGE
- Wait at least 5 seconds before switching the instrument on and then off again at the main switch.
- A defective device, regardless of the guarantee period, can be serviced only when the device is dismantled and the error is described. Please also inform us of the indicator type currently in use and the measured medium. Make no changes or modifications to the device that go beyond the scope of use specified in these instructions. Doing so will void the warranty. This applies particularly to the measuring chamber, the seal of which must remain undamaged. If you send the device in for repair, please completely empty the measuring chamber and remove the indicator bottle and the drain funnel. Also remove the power pack and send it back in the original packaging.
Before dismantling, the type of error must be noted (error number, error effect, log file of the SD card).
- Once a protective device has been triggered (safety fuse), initially try resolving the cause of error (e.g. by replacing a defective valve), before reactivating the protective device. Frequent triggering always signifies an error, which under certain circumstances may also damage the device.
- **Before sending the device in for maintenance or repair, package the power pack individually in the original box in which it was delivered. If the original packaging is no longer available, package the power pack to prevent breakage.**

Key combinations when switching on



You can gain access to some service functions when you press a key or a combination of keys when switching on the device. The following table gives you an overview of the possible combinations.

Key	Function
	Calibration mode
	Basic programming
	Skip automatic venting
 	Factory settings, SD format, empty/fill measuring chamber, pumps, etc. Caution! The SD card will be deleted.
	Show operating hours
	Test program
	Set up language
  	Password reset
 	Demo mode
  	Import/export customer data. If there is no export file, the export will take place. If there is data, the import will take place

Prior to carrying out maintenance work

Carry out a visual inspection of the instrument:

- Are the instrument doors closed properly?
- Is the instrument heavily soiled?
- Is there air inside the dosing hoses?
- Are the hose connections of the dosing pump free of leaks?
- Has the use-by date of the indicator expired?

Always make sure that the sight-glass windows are clean before inserting a new indicator bottle.

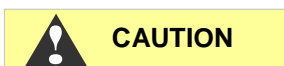

CAUTION

Cleaning agents

- Never use organic solvents to clean the measuring chamber or other plastic parts!
- Use an acidic cleaning agent for cleaning.
- Please observe the safety regulations when handling cleaning agents!

Permissible tools



Only use suitable tools for the work described, e.g., our tool set T2000 (Art. No. 40138) and our maintenance case T2000 (Art. No. 270338) with all necessary spare parts for regular maintenance.

Content of the tool kit T2000 (Art. no. 40138)

Size	Application	Art. no.
Torx, TX 20x100	Measuring chamber, snap-on installation	30991
Torx, TX 10x80	Measuring chamber holder	30992
Torx, TX 8x60	Display circuit board , measuring chamber holder	30993

Carrying out maintenance

This service manual describes maintenance work that goes beyond the regular maintenance work described in the “Maintenance and repairs” chapter of the operating manual.

see Operating manual

- Replacing the indicator Page 66
- Setting the indicator level Page 67
- Cleaning the measuring chamber and the viewing window Page 67
- Cleaning the filter housing Page 67
- Replacing the buffer battery Page 68
- Replacing the fuses Page 69

Removing and installing the measuring chamber holder

(Required tool: Torx 10)

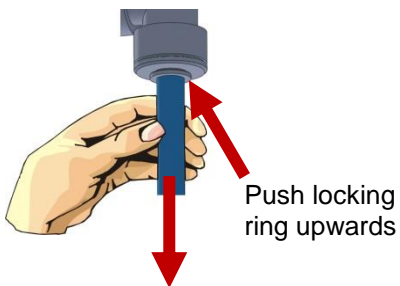
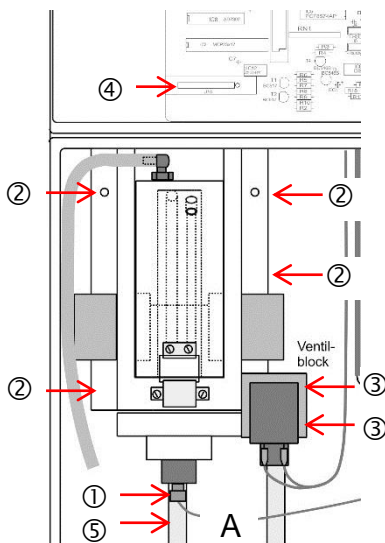

- Stop the water supply to the instrument.
- Drain the measuring chamber.
- Switch off the instrument.
- Unhook the toggle type fastener.
- Tilt the measuring chamber upwards and remove it.
- Remove the stirring bar.
- Loosen the pressure hose ①.
- Loosen the four fastening screws of the measuring chamber holder ②.
- Loosen the valve block ③ from the measuring chamber holder (two fastening screws).
- Disconnect the plug from the flexible cable connection ④ on the base circuit board by pressing together and raising the two lateral levers.
- Unplug the flexible cable.
- Remove the measuring chamber holder from the front. To achieve this, remove the drain pipe ⑤ from the hose connection of the measuring chamber holder (see fig. push locking ring upwards).
- Install the new measuring chamber holder in reverse order.
- Ensure that the plug is locked into position after inserting the flexible cable connection.

Cleaning of clogged solenoid valves

When the solenoid valve is clogged with impurities, the measuring chamber is not properly emptied. In this case, the solenoid valve can be carefully cleaned.

For dismantling all Testomat devices, please proceed as follows:

- Switch off the device and disconnect it from the power supply.
- Shut off the water supply in the supply line to the Testomat device.
- Open the lower door.
- Loosen the hose ① from the plug connector
- Loosen the 4 cable connectors ② from the coils of the solenoid valve.
- Loosen the 2 screws ③ that hold the solenoid valve in the housing. (Torx 10)
- Remove the solenoid valve forwards out of the housing.

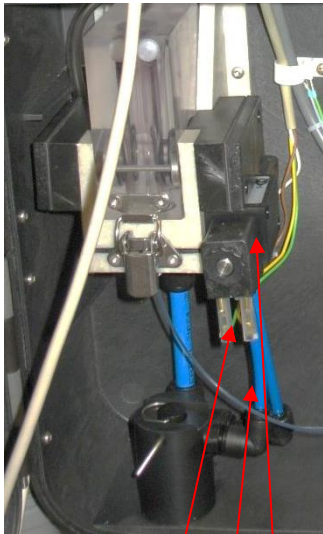

② ① ③

To clean the solenoid valve, disassemble each side separately as follows:

Start with the outlet side. On this side, the membrane of the valve core may get stuck in the drill hole when the valve is contaminated. The problem can be resolved mostly by loosening the membrane and cleaning the drill hole.

- Slide the retaining clip ④ upwards from the anchor sleeve. To facilitate loosening, the upper lug can be lifted carefully using a screwdriver.
- Pull off the ⑤ coil
- Unscrew the ⑥ anchor sleeve (SW 13)
- Loosen the two screws of the metal plate ⑩ on the valve body and remove the anchor sleeve ⑥.
- Carefully pull out the ⑦ anchor with the spring from the anchor sleeve. Ensure that the anchor is not released. If the membrane does not come loose and the valve core cannot be extracted, blow compressed air into the hole so that the membrane comes loose.
- When you blow compressed air through the valve, make sure that the O-ring ⑨ is not lost from the drill hole to the measuring chamber. Therefore, remove the O-ring before every cleaning operation.

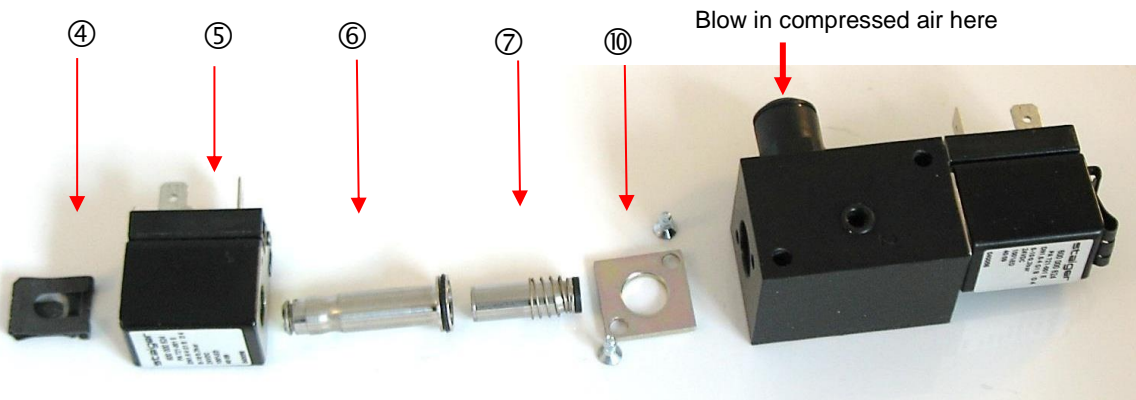
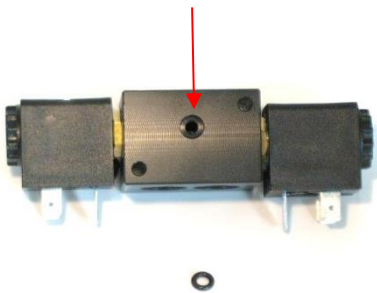

- When microbial contamination or deposits are present, clean the valve chamber and the parts of the valve ⑩ with a small brush (e.g. from our cleaning brush set, Art. No. 32287).

**CAUTION****Use of cleaning agents**

- Never use organic solvents to clean the measuring chamber and other plastic parts!
- For cleaning, use an acidic cleaning agent.
- Observe the safety instructions when handling cleaning agents!

- Carry out assembly by following the steps for dismantling of the same in reverse.

Make sure that you place the coil the right way round on to the anchor sleeve, as shown in the image above. The coil can be easily placed on to the anchor sleeve in only one direction.

- Now disassemble the inlet side in the same way, as described for the outlet side.
- Clean the inlet side, as described above.
- After cleaning, reassemble all parts.

Additional cleaning instructionsProcedure in the event of corrosion:

Temporarily place the tie rod in a metal cleaning solution (no longer than 5 minutes, depending on the concentration). Subsequently, neutralise with plenty of clear water.

Under no circumstances must sandpaper be used!

It is far better to use metal-free cleaning fleece, e.g. from the company Rothenberger

Procedure in the event of crystalline deposits:

Place the tie rod in either vinegar essence, pre-dissolved granulated citric acid, or some limescale remover. In this case also, allow it to take effect for no longer than 5 minutes. Subsequently, neutralise with plenty of clear water, and, where appropriate, rework using metal-free cleaning fleece.

Prior to assembly:

Please wet the parts in direct contact with the medium with a fine water-repellent silicone grease or spray, e.g. Baysilone

It is resistant to water vapour, sulphur dioxide, dilute acids and alkalis, and also is physiologically indifferent, skin-friendly and has excellent dielectric properties.

When all of these instructions are implemented, older valves will also work again properly for a long time.

NOTE**Risk of interchanging parts**

Do not interchange the inlet and outlet sides when mounting! The springs are not identical. The solenoid valve no longer works when it is incorrectly assembled.

Do not interchange the cable connectors of the inlet and outlet sides when reconnecting (inlet: yellow-green cable; outlet: brown-white cable). If necessary, take a photo prior to removal.

Ensure that the drill hole ⑨ appears in the solenoid valve to the measuring chamber.

Do not attempt to forcibly install the solenoid valve. If there are problems, check whether the solenoid valve has been properly assembled and screw on to the measuring chamber using the correct side.

- Reconstruct the solenoid valve by following the steps for dismantling of the same in reverse.

Repairing or replacing the dosing pump

NOTE

Maintenance rate

The dosing pump DOSIClip® is a high-precision piston dosing pump, which makes up to 400 000 pump strokes per year depending on the settings (a measurement all 10 minutes x 4 pump strokes every day). To ensure proper operation for many years, we recommend sending in the pump for servicing **every 2-3 years**.



CAUTION

Calibration on-site not possible!

We would like to point out that a repair of the dosing pump should be performed only marginally, because calibration of the dosing pump on-site is not possible.

We recommend exchanging a defective pump and sending it in for servicing to the factory.

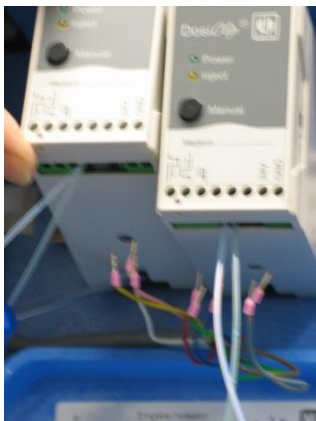

A pump which does not function properly results in incorrectly measured values (e.g. error message "36 Fault Analysis"). If you have problems with the dosing pump, we recommend replacing it.

Proceed as follows to replace it:

1. Switch off the instrument.
2. Loosen the five cables of the terminal connections using a suitable screwdriver.
3. Loosen the hose connections at the indicator bottle and at the measuring chamber holder.
4. Collect the indicator in a container!
5. Use a screwdriver to push the lock of the pump housing downwards and remove the housing from the top
6. At first, place the replacement pump on top of the DIN rail and push the housing downwards until the lock engages
7. Reconnect the cables (observe the colour sequence!)
8. Reconnect the hose connections (note the suction and pressure side!)

Replacing the dosing pump valves

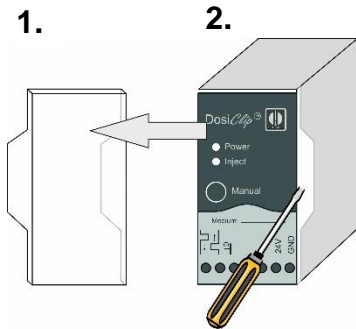

In certain cases and with an obvious cause of malfunctioning, it is also possible to replace the pump valves. Please proceed as follows:

1. Remove the transparent cover.
2. Use a suitable screwdriver to remove the electronics from the housing (snap-on installation).
3. Replace the hoses or valves (observe the direction of installation).
4. Re-assemble the pump in reverse order. Please make sure that wires and hoses are not trapped.

3.

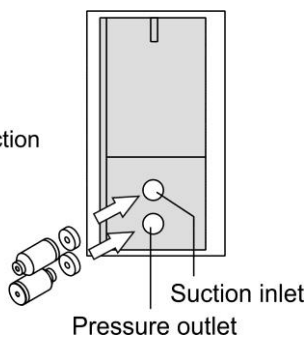

Checking the dosing pump

Proceed as follows to check correct functioning and the dosing quantity of the dosing pump:

- Press the "PAUSE" key
"PAUSE" LED illuminates.
- Make sure that the measuring chamber is empty.
- Remove the pressure hose from the measuring chamber holder.
- Subsequently press the "manual" key on the dosing pump.
- The dosing quantity must be a single drop (30 µl) and should drip from the pressure hose
- Collect the indicator in a container!

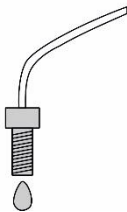
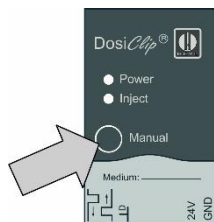

Checking dosing

When measuring the hardness, it is checked whether the yellow value is at least 50 below the limit value after each (except the first) dosing stroke. Each stroke usually results in the value being reduced by 80 to 100 digits.

- Manually activate the dosing pump once (see page 15).
- In "Adjust mode", display the yellow value under "G:####".

NOTE

It is essential that the stirrer is switched on during the checking procedure.

Checks can only be carried out with indicator type TH!

The limit values are as follows (for exact adjustment to 900):

The limit values are as follows (for adjustment to 900 +/- 20 digits):

The following table shows an adjustment example:

Stroke	Yellow LED
0	900 (= clear water)
1	809
2	726
3	662
4	609
5	566
6	531
7	500
8	477
9	457
10	441
11	427
12	416
13	405
14	393
15	385

Special function "Adjust mode"

The adjust mode is used for testing the overflow detection and the optical amplification setting.

NOTE

The amplification setting is carried out in the normal measuring mode of the instrument, i.e. manual adjustment is not required. The test described below is only used for checking and error detection.

Call of adjust mode



- Press and hold the  key and switch on the instrument.

Back to measuring mode

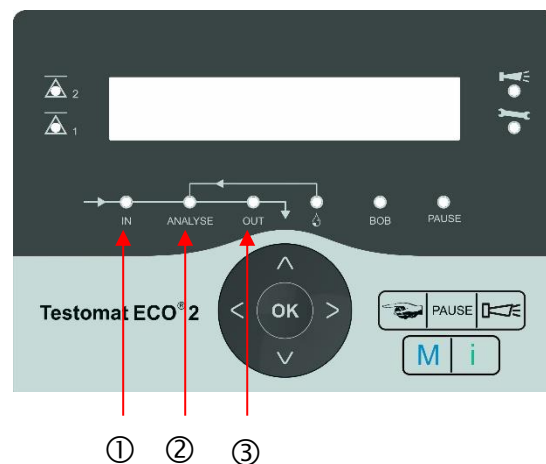

- Press the  and  keys simultaneously.



Testing of the overflow detection

- Press the  key to open the input valve IN.
The "IN" LED ① illuminates.
- The "ANALYSIS" LED ② must illuminate when the water flows through the overflow borehole of the measuring chamber. If this does not occur, check the water intake (incoming water), the viewing window (contamination) and the flexfilm (plug, corrosion).
- Press the  key to open the output valve OUT.
The "OUT" LED ③ illuminates.

Checking the automatic adjustment

- Prior to adjustment, fill the measuring chamber with deionised water (VE water) until overflow occurs.
- Switch to “Adjust mode” (see “Calling adjust mode”).
- Press the  key to switch on the transmit diodes and the stirring mechanism.
- Press the  key to start automatic adjustment.
- Read the values for yellow (Y:) and red (R:). Both values have to be 900 +/- 20.

If these values are not achieved, it may be due to the following reasons:

- The water is turbid.
 - Air bubbles in the water.
 - The measuring chamber is not filled correctly.
 - The sight-glass windows are soiled or cracked.
 - The receiver optics (lenses) is soiled.
 - The plug connector of the flexible cable is not locked (loose contact).
 - The measuring chamber holder is leaky, entered water has destroyed the electronics on the circuit board.
-
- Press the “Manual” button on the dosing pump.
A colour change must take place in the measuring chamber (see also “Checking dosing” on Page 14).

Manual measured value check

The measured value check of the Testomat instruments is usually carried out during a laboratory analysis of the measuring water. In special cases, this check can also be carried out via direct input of a standard solution, created especially for this task, into the measuring chamber.

NOTE

Creating a standard solution

- The standard solution must be created on-site for rapid application.
- For example, take a 1000 ppm solution and dilute it until you achieve the desired value in the upper third of the measuring range.

Manual supply of the standard solution

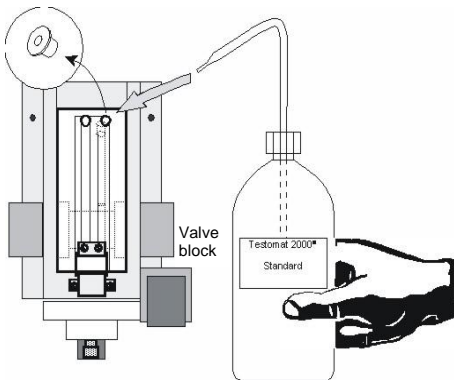

- Please stop the water supply to the instrument.
- Please remove the right-hand plug from the measuring chamber. The measuring chamber is manually filled with the standard solution via this borehole after starting the measurement. Common laboratory spray bottles can be used for this task.
- To start the check, activate the measurement via the  key.
- Testomat starts with an analysis cycle. If you have programmed a flushing time, do not fill the measuring chamber until the output valve has closed ("OUT" LED extinguishes).
- Fill the measuring chamber with the standard solution until it overflows. The input valve closes ("IN" LED extinguishes). This solution is then drained (flushing the measuring chamber).
- Once the output valve has closed ("OUT" LED extinguishes), refill the measuring chamber with the standard solution until it overflows. The filling level falls to the intended sample volume.
- The measured value is displayed once the analysis has finished.

Troubleshooting

In this section, you will find the most common error messages, possible causes and how to resolve them.

A complete table with all error messages, possible causes and troubleshooting measures can be found from Page 58 onwards in the Operating manual.

Error message “36 Fault analysis”

A measuring fault analysis occurs when the water in the measuring chamber is too “light” after the second dosing.

Check the following points if “36 Fault analysis” is displayed:

1. The indicator’s expiry date has been exceeded.

Remedy:

- There is insufficient dye in the indicator. Use a new indicator.
- When using an indicator that is not from Gebr. Heyl, replace it with the one recommended by us.

2. The stirring bar in the measuring chamber holder fails to rotate, resulting in an insufficiently mixed indicator.

Remedy:

- The stirring bar is stuck due to soiling in the stirring area of the measuring chamber holder. Clean the measuring chamber.
- The measuring chamber holder is leaky, entered water has destroyed the electronics on the circuit board. Change the measuring chamber holder.
- The plug connector of the flexible cable is not locked (loose contact). Insert the plug properly into the socket.
- The magnet in the stirring bar is too weak. Change the stirring bar.
- If necessary, insert a stirring bar.
- Check the plug contact of the flexible printed circuit board. If necessary, replace the measuring chamber holder.

3. The pump doses insufficient indicator.

Remedy:

- Check the dosing pump (see “Checking the dosing pump”). If necessary, replace the dosing pump.
- Check pump dosing (see “Checking dosing”). If necessary, replace the dosing pump.

4. Air is trapped in the indicator hose.

Remedy:

- Bleed the dosing hoses by pressing the “Manual” button on the dosing pump several times.

- Make sure that all the indicator hoses are fitted correctly. If not, air may enter the hoses!
- If the error re-occurs, replace the bottle insert for a screw cap with a suction tube (art. no.: 40135).
- Make sure that the suction and pressure hose set is not kinked or trapped. If necessary, replace the hoses. Complete suction hose (art. no. 40011), complete pressure hose (art. no. 40016).

5. The water pressure is insufficient. Water is supplied, but the water level inside the measuring chamber remains too high after closing the inlet valve.

Remedy:

- The water level should be approx. 32 mm above the lower edge of the transparent measuring chamber block.
- Make sure that the water pressure is within the valid range of 0.3 - 1 bar (without valve body) and 1 - 8 bar (with valve body).
- Make sure all the dummy plugs are in place at the measuring chamber (e.g. after maintenance). Make sure all the dummy plugs are fitted correctly, thus preventing air leaks.

6. The drain pipe is blocked. Water may collect and stand in the pipe.

Remedy:

- Make sure the water outlet is not blocked. If necessary, clean it.

7. The measuring chamber is soiled.

Remedy:

- All the channels in the measuring chamber and the measuring chamber sight-glass windows must be free of indicator residue or any other type of contamination.
Dirt can be removed with either ethyl alcohol or another commercially available plastic cleaner.
- Also clean the receiver optics.

8. The measuring water must be completely free of bubbles when carrying out measurements and should not have a milky appearance.

Remedy:

- Make sure there are neither air bubbles nor more than 20 mg/l CO₂ in the measuring water.
Air bubbles or milky measuring water may be the result of incorrect regeneration of the softening plant or residual salt in the soft water. Use our aerator R (art. no. 130010).

9. Iron (< 0.5 mg/l), copper and aluminium ions (<0.1 mg/l) may impair the measurement.

Remedy:

- This is probably caused by old iron pipes, new copper pipes or changes to the well water. Pay attention to the composition of the measuring water.
Use our colourimetric test kits for iron (art. no. 410547) and copper (art. no. 410562) when carrying out checks.

10. Oxidation on the flex film in the measuring chamber holder.

Remedy:

- Replace the measuring chamber holder.

11. Measuring chamber was not correctly filled.

Remedy:

- Check if the closing plugs in the measuring chamber fit tightly. Pay special attention to the rear plug. If it doesn't fit, air is sucked through and the measuring chamber cannot siphon correctly. This leads to low water in the measuring chamber or overflowing.
- Replace old or missing closing plugs with new (service case art. no. 270335). If you don't have these on hand, use a tape to help, until you've got the spare part.
- Check the inlet solenoid valve. Excessive or insufficient water in the measuring chamber indicates incorrect opening/closing of the solenoid valve.
(foreign particles / wear)
Indicator and water quantity must be correct. Otherwise it will result in incorrect measurements.

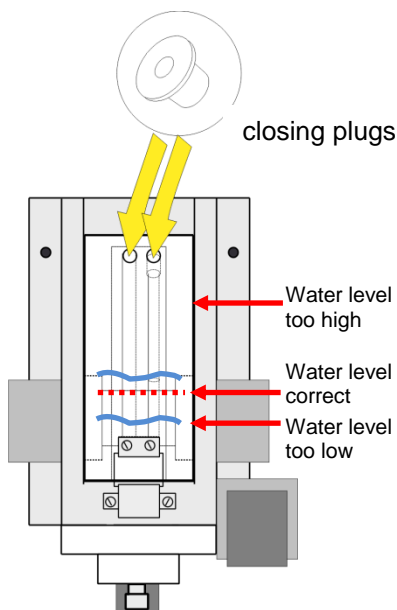

Error message “38 Water low”

Remedy:

- Check the inlet water (filter strainer, etc.) for foreign particles. If necessary, clean the filter strainer.
- There is no inlet water even though the IN lamp is lit. Check the inlet water connection.
- The inlet pressure is too low (less than 1 bar). Remove the pressure valve body (see “Cleaning the controller/filter housing”).
- Typically 400 ml/min must flow through the measuring chamber to flush and fill the measuring chamber.
- The inlet solenoid valve is defective. Check the F2 and F4 fuses on the power supply board and the plug contact at the inlet valve.
- Oxidation on the flex film in the measuring chamber holder. Replace the measuring chamber holder.

Error message “33 Fault optics”

Remedy

- There is an error at the optical component. The receiver is defective. Replace the measuring chamber holder.
- Cold water (<8°C) combined with a warm and humid ambient temperature (>28-30°C) can lead to the formation of water drops on the sight-glass windows.

Error message “34 Fault turbid”

Remedy:

- Check whether the supplied measuring water is very turbid or soiled.
- Check whether the sight-glass windows are soiled and, if necessary, clean them.
- Make sure the flex film is dry. If you detect water damage, replace the measuring chamber holder.
- If necessary, install a filter (art. no. 11217) in the inlet of the instrument.
- Cold water (<8°C) combined with a warm and humid ambient temperature (>28-30°C) can lead to the formation of water drops on the sight-glass windows.

Error due to defective hardware

1. The dosing pump runs permanently.

Remedy:

- Check whether the broadband cable at the main and front board is loose or defective.

2. The inlet valve allows water to flow through it.

Remedy:

- Check whether the inlet valve is soiled.

3. The outlet valve allows water to flow through it.

Remedy:

- Check whether the outlet valve is soiled. Is there a permanent voltage on the valve?
This would be the result of a software and hardware error. Carry out a reset (see operating instructions).
If this fails to eliminate the error, replace the valve.

4. Stop input terminals 19 and 20, no function.

Remedy:

- The PAUSE key of the device has been activated.
- The optocoupler might be defective.
External voltage has been applied to terminals 19 and 20. However, only a volt-free contact should be applied here (see operating instructions).
- To check the optocoupler, measure the current at contacts 19 and 20.
There must be approx. 10 mA at terminals 19 and 20!
- Open the Diagnostics menu and check the level at the stop input.

Readjusting the current interface

The current interface is calibrated ex-factory and is set at several points.

- Contact your customer service.

Spare parts for Testomat® EVO TH

Art. No	Pressure controller
40125	Controller / filter receiver , complete
40120	Controller / filter receiver
40129	Controller plug T2000, complete
11225	Flow controller valve body, complete
11230	Retaining pin for controller plug
11217	Inlet filter
11218	Spring for inlet filter 19.5dx25
40121	Inlet connector
40153	Plug-in connector G 1/4" -6
40157	Angled plug-in connector G 1/8"
Measuring chamber	
40173	Sight-glass window 30 x 3 with seal
40170	Sight-glass window 30x3
40176	Sight-glass holder, countersink and thread
33253	Bolt M3x40, A2, DIN 965
40032	Latch fastener TL-17-201-52
11210	Plug for measuring chamber
40022	Measuring chamber T2000 complete
Measuring chamber holder	
40029	Measuring chamber holder complete ET
40050	Magnetic stirrer, processed
40156	Plug-in connector 3/8" -10, processed
40056	Solenoid valve, 2/2 ways, Testomat® EVO TH
DosiClip® dosing pump	
270470	DosiClip dosing pump
40011	Suction hose, complete
40016	Pressure hose, complete
40040	Valve set
32046	Plastic cover CNH 45 N
Bottle connection/suction device	
40131	Screw cap with bottle insert T2000
40130	Screw cap GL32 - hole
40135	Bottle insert for screw cap with push-fit suction tube

Art. No	Device spare parts
31582	Fuse GS-M 5x20E 4A MT
31655	Fuse T2A (24V)
12140	Fuse T1.6A (12V/3.3V)
31622	Fuse T0.16A
31585	Fuse T0.315A
32383	Base circuit board complete 230V
32387	Control circuit board complete
32385	Display circuit board EVO complete
37734	Cable ducting M16 x 1,5
37735	Nut for cable ducting M16 x 1,5
37736	Blanking plug for cable ducting
31713	Ribbon cable 10 pol. with ferrite
31656	Jumper
40060	Cable loom 2V, complete, for T2000
40062	Cable loom 2P, complete, for T2000
37320	Standard SD card 2 GB
31999	Lithium backup battery CR2032
32389	Multi-range power supply board 100V – 240V
32390	Power supply board 230 V
32187	Drain funnel
Spare parts required for 2 - 3 years of operation	
40173	Sight-glass window 30 x 3 with seal
11217	Inlet filter 19.5dx25
40124	Gasket set T2000 (according to maintenance requirements)

Component positions

Controller board complete (32387)

Power supply board 230V (32390) or Multi-range power supply board (32389)

Motherboard complete 230V (32383)

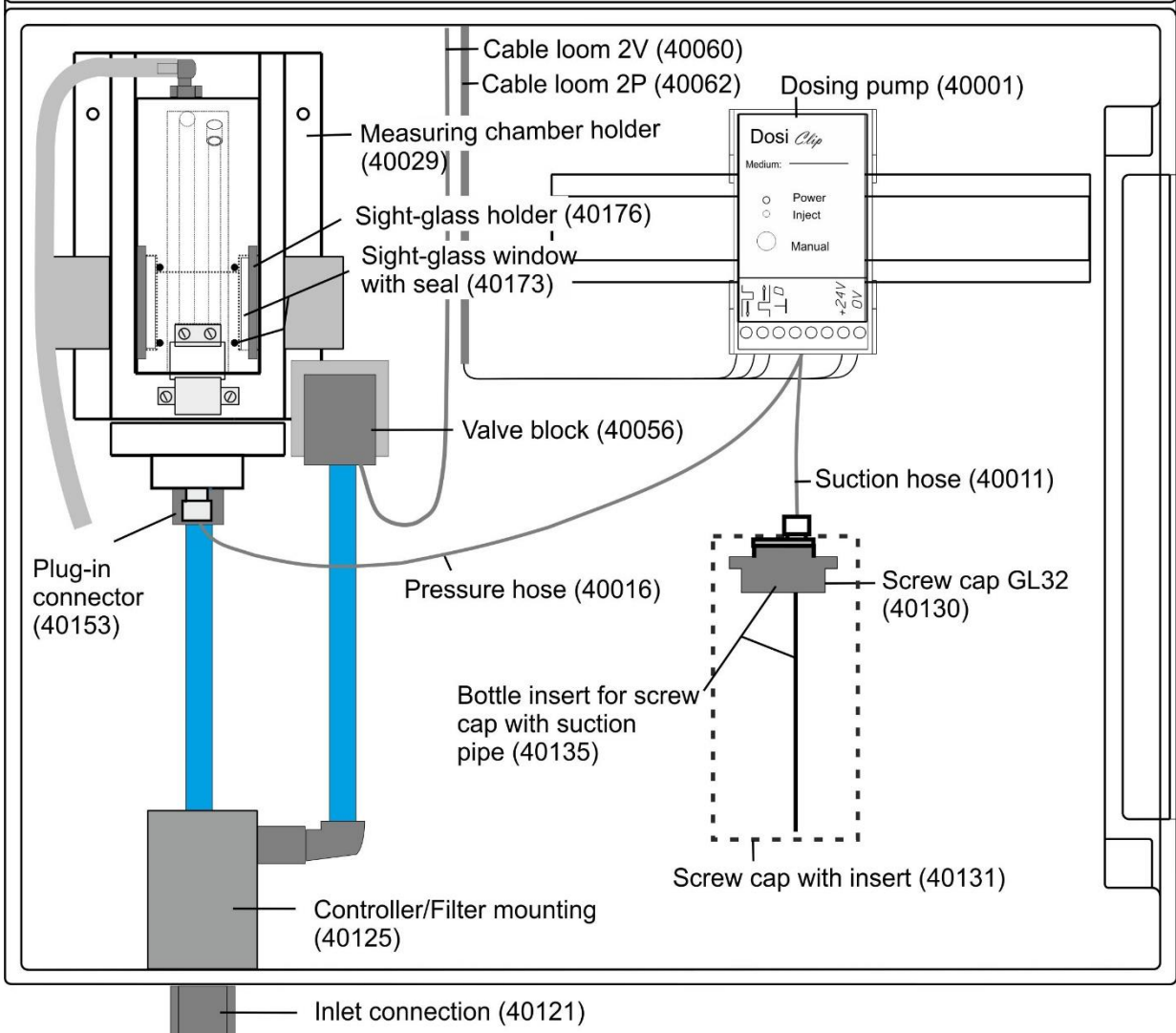
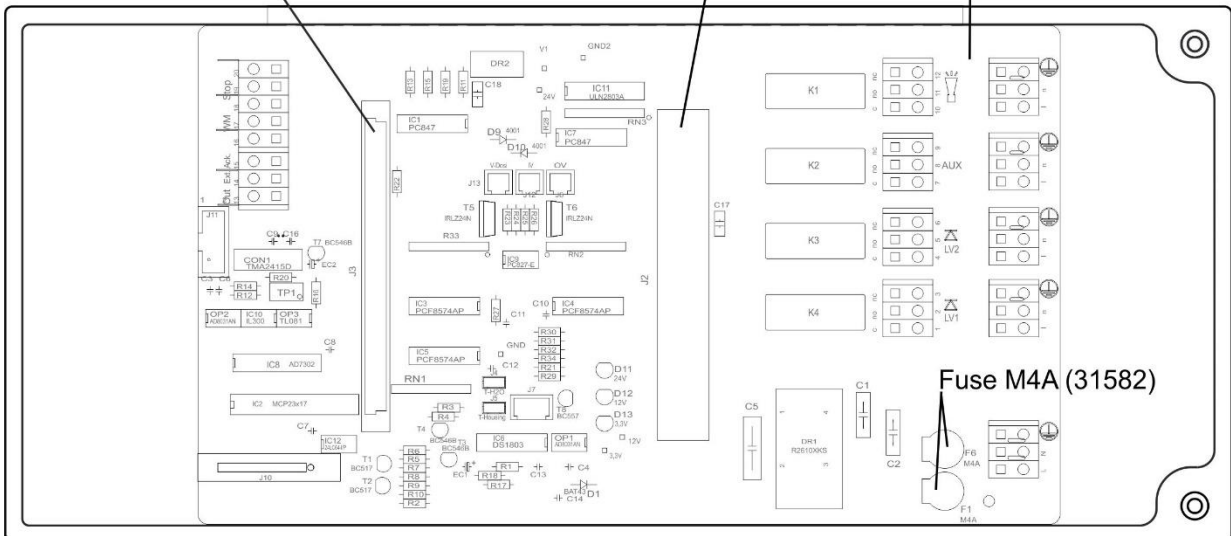

Controller/filter receiver, with tube

Item no.	Name	Article number	Quantity
1	Controller / filter receiver	40120	1
2	Controller plug	40129	1
3	O-ring	11249	2
5	Flow controller valve body,	11225	1
7	Locking pin	11270	1
8	Angled plug-in connector	40157	1
9	Inlet filter	11217	1
10	Spring for inlet filter	11218	1
11	Flat seal 24x2	33777	1
12	Inlet connector	40121	1
13	O-ring 20x2	11216	1
14	Plug-in connector	40153	1
15	Pipe OD 6x82	37754	1
16	Plug-in connector	40150	1

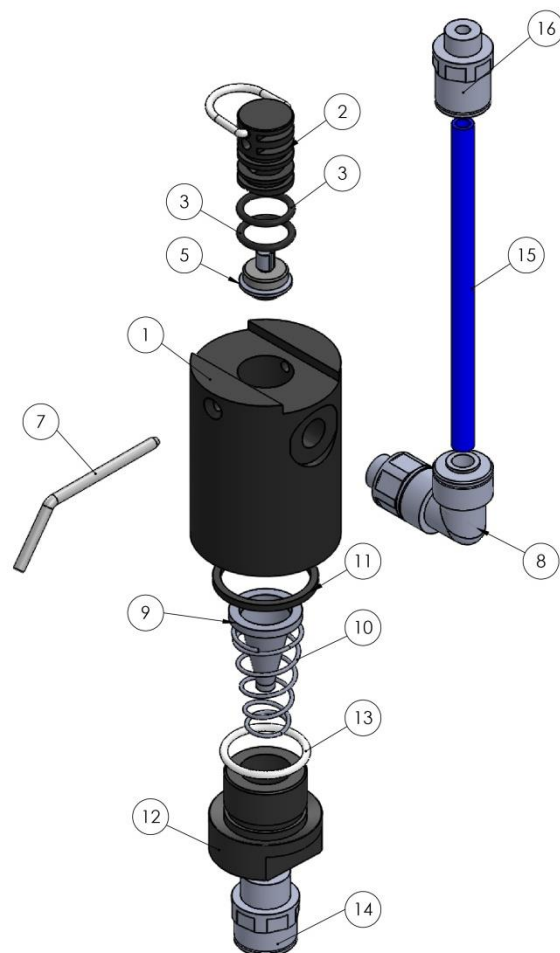

Drainage and piping

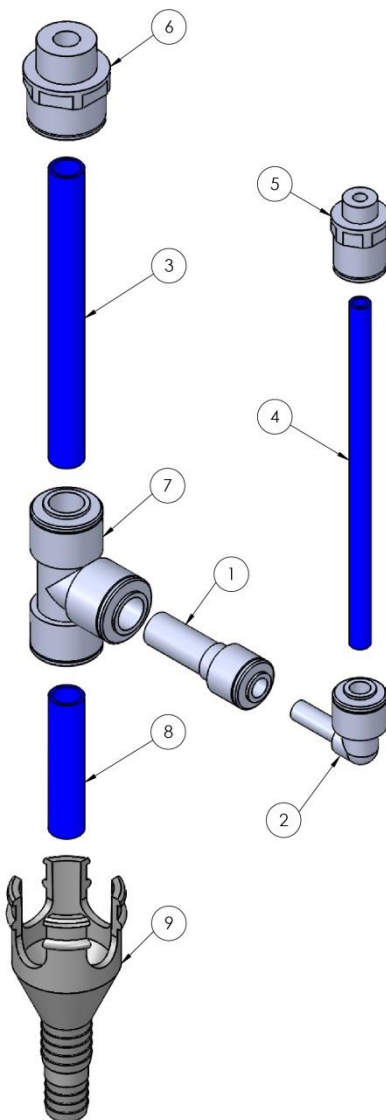

Item no.	Name	Article number	Quantity
1	Reducing connector 10-6	40152	1
2	Plug-in angular connector 6-6	40154	1
3	Pipe 10x98	40240	1
4	Pipe 6x115	40142	1
5	Plug-in connector G1/8" - 6	40150	1
6	Plug-in connector G3/8" - 10	40156	1
7	T connector 10	40112	1
8	Pipe 10x45	35863	1
9	Drain funnel	32187	1

Content of the gasket set T2000 (Art. no.: 40124)

Number, size	Position	Art. No.
1 x O-ring 18x2	Measuring chamber holder	33776
1 x O-ring 4.47x1.78	Valve block	33775
4 x flat seal 24x2	Pressure controller, measuring chamber and measuring chamber holder	33777
1 x O-ring 20x2	Inlet screw connection	11216
2 x O-ring 10.82x1.78	Controller plug	11249

Measuring chamber complete (40022)

Item no.	Name	Article number	Quantity
1	Measuring chamber housing	37810	1
2	Flat seal 24x2	33777	2
3	Sight-glass window 30x3	40170	2
4	Sight-glass holder,	40176	2
5	Bolt M3x40	33253	2
6	Plug for measuring chamber	11210	3
7	Angled plug-in connector	40320	1
8	Tube, PVC, 3,0/1,5, 200mm	35852	1
9	Latch fastener	40032	1
10	Bolt M4x8	33252	2

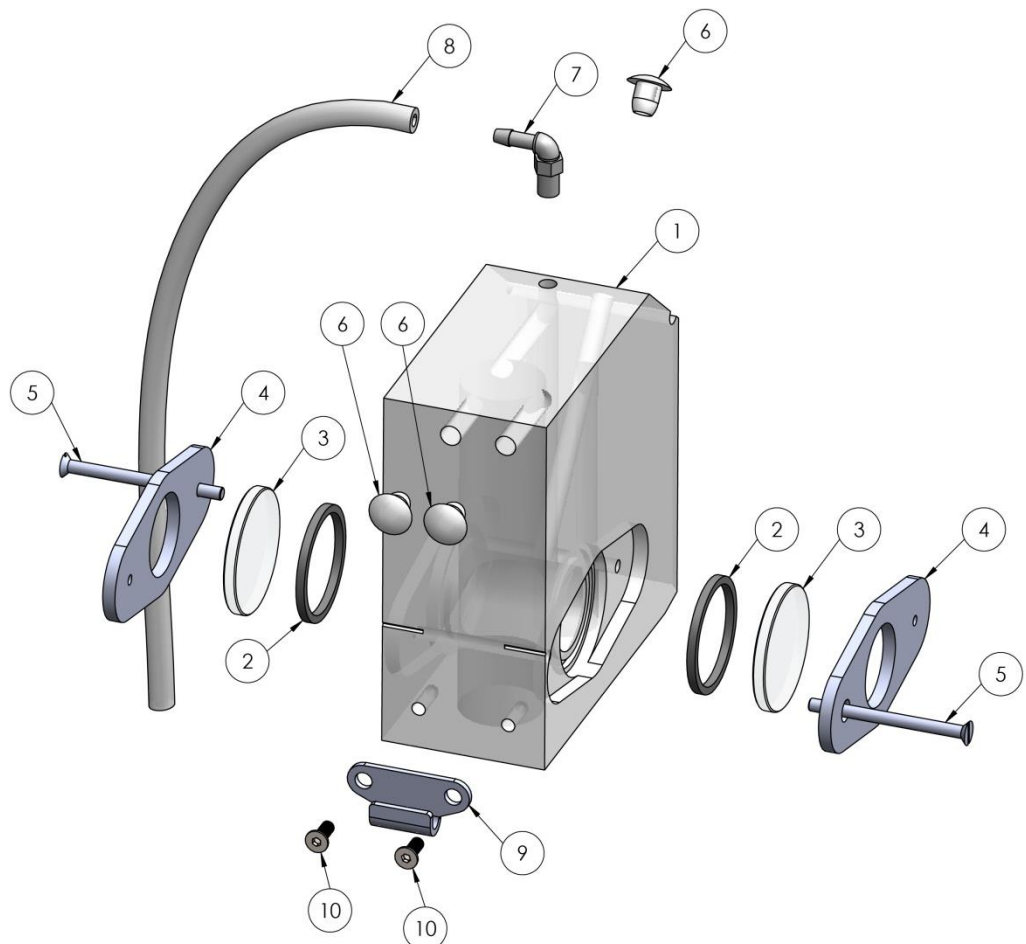

Checklist Testomat® EVO TH

Dear customers and service technicians,

The following checklist is no substitute for your expertise and experience applied to the process of troubleshooting. It should assist you and facilitate swifter and more systematic detection and logging of errors. No claim of completeness may be inferred from this list. We are grateful to receive supplementary feedback at any time. General operating instructions are included on the rear of this checklist.

Your device manufacturer

Block 1 / System and device data

	Testomat® EVO TH				
System type	Device type	Device number	Indicator type	Software version	Pump No.

Block 2 / error message and error history Please place a cross as appropriate (X)

What does the error history of the device indicate?				(Text of the error history)
Does an error message appear on the display? e.g. "Water low" etc. (See instruction manual "Error messages / Help dealing with faults")	Yes	No		(Text of the error message)

Block 3 / Visual and functional check Please place a cross as appropriate (X) where applicable values / comments

Is the mains voltage for the device in accordance with the type plate?	Yes	No	
Does an indicator appear on the display?	Yes	No	
Do the three green LEDs light up to indicate the stresses on the mother-board?	Yes	No	
Do LEDs flash on the control card?	Yes	No	Which LED?
Are the measuring chamber and hoses carrying water leakproof?	Yes	No	
Is the measuring chamber clean and free of film?	Yes	No	
Has the correct indicator type been programmed in? (TH 2025 => 0.25 up to 2.5 °dH = Factory default)	Yes	No	Type:
Is the water pressure in the stipulated range (400 ml/min)? (See type plate of the device)	Yes	No	System pressure:
Is the outflow over the entire length laid to ensure no back pressure? (No "siphon effect"!!)	Yes	No	
Is the drain hose free? (Micro-organisms due to contamination etc.)	Yes	No	
Is the purge cycle / rinsing water quantity set such that Fresh water can always be measured?	Yes	No	Purge cycle:
Are the hoses to the dosing pump free of air bubbles? (Operate pump by hand / Perform manual analysis)	Yes	No	

PERFORM A (MANUAL) ANALYSIS

Does the water level rise uniformly when filling the measuring chamber up to the overflow hole (5 mm under the top edge of the measuring chamber)? (If no: check water pressure, water flow/flow regulator)	Yes	No	
Does the indicator pump dose when an analysis is triggered? (LED on the pump comes on!)	Yes	No	Number of dosing strokes:
After the dosing process, is the indicator correctly mixed with the water in the measuring chamber? Check the stirrer! => See maintenance manual "Alignment operation"	Yes	No	

PROGRAMMING DATA / OPERATING CONDITIONS

Are the configured limit values correct? (Within the measurement range/corresponding to the performance limit of the system?)	Yes	No	Limit values:
Is the Testomat continually supplied with mains voltage – except during maintenance work/emergency cases? (Intermediate switching off only with "PAUSE" button or "Stop"! input)	Yes	No	

More details of error messages and possible causes of errors can be found in the **operating instructions** under "Error messages / Help dealing with faults".

Further functional tests (e.g. overflow detection and gain adjustment => "Special function alignment operation") and service indications can be found in the **maintenance manual**.

After performing these tests, experience supports the assumption that the checked functions (Block 3) work flawlessly if the questions are answered with "Yes". We recommend carrying out these tests systematically during each inspection or any disruptions which arise.

Device settings for Testomat® EVO TH

Caution!

Your settings may be deleted in the event of a repair. Accordingly, export your device settings onto an SD card before sending the device for repair to our service team. The settings can be re-imported after the repair.

Menu	Setting
MODE OF OPERATION	
Time controlled	
Volume interval	
Volume and time	
INTERVAL	
Time	
Volume	
BOTTLE SIZE	
500ml bottle	
100ml bottle	
TYPE OF REAGENT	
Type TH2005	
Type TH2025	
Type TH2100	
Type TH2250	
DISPLAY OF UNIT	
Display °dH	
Display °f	
Display ppm CaCO ₃	
Display mmol/l	
LIMIT VALUES	
LV1:	
LV2:	
FLUSH TIME	
Flush	
ExceedanceFlush	
WATER METER	
1 l/Impulse	
2,5 l/Impulse	
5 l/Impulse	
10 l/Impulse	
100 l/Impulse	
500 l/Impulse	
1000 l/Impulse	
Imp./L	
BOB	
Function on	
FUNCTION LV1/LV2	
Limit value	
Two point	
Range	
RELAY LV1	
Hysteresis LV1	
Duration	
Impuls	
Interval	
Time:	
RELAY LV2	
Hysteresis LV2	
Duration	

Impuls	
Interval	
Time:	
RELAY AUX	
Before retry	
Before analysis	
During analysis	
Before + during analysis	
After analysis	
Time	
WATER LOW COUNT	
Count	
FUNCTION STOP	
Normally closed	
Normally open	
FUNCTION WM	
Normally closed	
Normally open	
EXTERN ACK.	
Normally closed	
Normally open	
CURRENT INTERFACE TYPE	
Type 0-20 mA	
Type 4-20 mA	
SERIAL INTERFACE	
Baudrate	
LCD SETTINGS	
Brightness	
Contrast	
FUNCTION SD CARD	
Store measurement	
Store error	
Import basic data	
Export basic data	
SERVICE TIME	
Interval	
LANGUAGE	
English	
German	
Français	
Nederlands	
Espanol	
Türkçe	
中文	
Czech	

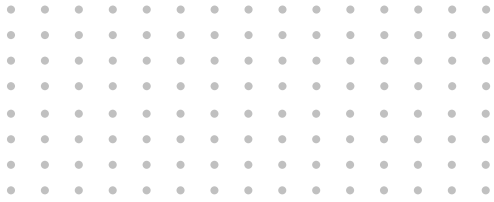

Gebrüder Heyl
Analysentechnik GmbH & Co. KG
Orleansstraße 75b
D 31135 Hildesheim
www.heyhl.de

Serviceanleitung_EVO_GB_190718.docx

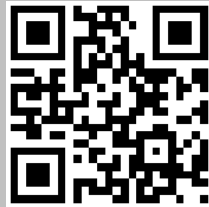

Scan the code and
visit us on our website!