

Operating Instructions

MultiControl CT

Controlling of cooling circuits



Contents

Contents.....	2
Important safety information	5
Intended use	5
Qualification of personnel	5
Warnings in this manual	6
Additional documentation	6
Special attention is required at this point	6
General Information	6
Requirements for the installation site.....	6
Requirements of cable for mains voltage and system components and installed lines	7
Requirements for cable ducts	7
During assembly	7
During operation	8
During cleaning.....	8
Malfunctions/repairing a defective device.....	9
During disposal	9
Operating requirements	9
Delivery includes:	9
Service description	10
Installation	12
Prior to installation	12
Assembling the MultiControl CT	12
Connecting the power supply and devices	12
After installation	14
Checklist for assembly and installation.....	15
Operating features and connections.....	16
Operating features	16
Connections on the motherboard	17
Fuses on the power supply pack plug-in card	18
Connections on the control board.....	19
Control elements on the control board.....	19
RS232 interface terminal assignment.....	19
Plug-in cards	20
Connecting the plug-in card EC/pH	20
Connecting the plug-in card EC inductive/pH.....	20
Connecting the ADI plug-in card.....	22
Probe adaptor card	22
Connection example	23
Connecting the measuring converters	23
Jumo CTI-500	24
Kuntze Neon LF	26
BKEX probe to probe adaptor card or plug-in card ADI	27
Other measuring converters	28
Commissioning	29
Mounting the SD card (optional)	29
Switching on/off the MultiControl CT	29
Calibrating the probes	29
Menu structure	30
Call menu	30
Select menu	30
Navigate to the desired menu item or input area	30

Return to the higher order menu level	31
Enter/change values	31
Exit menu	31
Time and date	31
Display number and date of the software	32
Operation	33
Key functions.....	33
Display	33
Operating display	33
Signal lamps	33
Function characteristics of the controller for cooling circuits	34
Desalination function.....	34
Metering function – Solenoid valve.....	34
Metering function – Motor valve.....	34
Basic program menu	35
Select mode	35
Set the factor for measuring the TDS	35
Set the desalination function.....	35
Closing time	36
Max. desalination duration	36
Define dosing.....	36
Biocide 1 / 2	36
Output K1	37
Change cell constant	40
Inductive probe	40
Measuring range CD	40
Interface type CD	40
Min. temperature	41
Max. temperature	41
Interface type temperature.....	41
Define limit values.....	41
Define min. limit value	41
Define max. limit value	42
Set test time	42
Temperature	42
Selecting the unit.....	42
Temperature display	42
Temperature alarm.....	43
Temperature compensation	44
Setting the pH temperature sensor	45
Calibrating the pH temperature sensor	45
Setting the CD temperature sensor	46
Calibrating the CD temperature sensor	46
Configuring the pH probe.....	46
Alter the language on the display	47
Serial interface.....	47
Notification format	47
Baud rate.....	48
SD card functions.....	48
Displaying free storage space.....	49
Storing measurement values	49
Storage interval	49
Save alarms	49
Interim storage for a non-inserted SD card.....	50
Capacity of the SD card	50
Saving changes.....	50
Import basic programming data	51
Export basic programming data	51
Settings for the ADI card.....	53
Configuring the current interface.....	53

Specify scaling	53
Selection of displayed signals	53
Baud rate	54
LCD settings	54
Alarm/message – How to proceed when errors occur	55
Standby mode	55
Configuring the idle state of the inputs	56
Password	56
Enter password	56
Change password	56
Password protection	57
Firmware Update	57
Menu-driven firmware update	57
Manual firmware update	58
Service menu	59
Service info	59
Service interval	59
Displaying or resetting the operating hours	60
Time and Date	60
Configuring the time format	60
Displaying or deleting the error history	61
Diagnosis	61
Inputs	61
Outputs	62
Calibrating the probes	62
pH probe	62
Conductivity probe	63
Inductive conductivity probe	65
Factory settings	65
Servicing and maintenance	66
Replacing the backup battery	66
Reset service interval	66
Reset operating time counter	66
Replacing fuses	67
Troubleshooting	67
Error messages/troubleshooting	69
Further possible errors	71
EMC malfunctions due to the solenoid valves	71
Error messages after self-test	72
Firmware update error list	73
Disassembly	76
Structure of service menu	77
Structure of basic programming	77
Structure of information menu	81
Accessories	82
Conductive conductivity probes without temperature sensor	82
Conductive conductivity probes with temperature sensor PT100	82
Inductive conductivity probes with temperature sensor	83
pH probes without temperature sensor	83
pH probes with temperature sensor	83
Technical Data	84
Conformity Declaration	85

Important safety information



Read the operating instructions carefully and in full before working with the device.

Ensure that the operating instructions are accessible at any time for all users. When an SD is used in the device, it can also be stored on the same as a PDF file.

If transferring the MultiControl CT device to third parties, ensure these operating instructions are always included.

Observe the safety precautions and safety recommendations when using reagents, chemicals and cleaning agents. Observe the relevant safety data sheet! For reagents we supply, the relevant safety data sheets are available online at <http://www.heyl.de>.

Intended use

The MultiControl CT is designed to control cooling circuits.

As a conductivity measurement device, you can use a suitable conductivity probe to monitor the conductivity in aqueous media and to regulate process water circuits.

Comply with the output limits specified in the "[Technical Data](#)" section.

The scope of intended use presumes that you have read and understood the instructions and particularly the section on "[Important safety information](#)".

Improper use is deemed to occur if you use the device

- outside the applicable scope, as specified in these instructions,
- under operating conditions that deviate from the scope specified in these instructions.

Qualification of personnel



The assembly and commissioning require basic electrical and process engineering expertise as well as knowledge of the applicable specialist terms. The assembly and commissioning must therefore be performed only by a specialist or a properly trained person instructed and supervised by a specialist.

A specialist is a person who can draw on professional training, knowledge and experience as well as knowledge of applicable provisions to assess work assigned to him/her, detect potential hazards and implement suitable safety measures. A specialist must comply with the applicable professional rules.

Warnings in this manual

These instructions include warnings against specified actions that involve the risk of injury or property damage. Warnings are structured as follows:



Description of the type or source of danger

Description of the consequences of non-compliance

Hazard prevention indications. Compliance with these hazard prevention measures is imperative.



The signal word "**DANGER**" refers to a significant danger that represents a direct threat and will definitely result in severe injuries or even be fatal if not avoided.



The signal word "**WARNING**" refers to a possible danger that may result in severe injuries or even be fatal if not avoided.



The signal word "**CAUTION**" refers to a potentially dangerous situation that could result in minor to moderate injuries or property damage if not avoided.



The signal word "**NOTE**" refers to important pieces of information. If this information is not heeded, it may adversely affect operational procedures.

Additional documentation

Das MultiControl CT is a plant component. You should therefore also observe the system documentation of the system manufacturer.

Special attention is required at this point

General Information



- During assembly and commissioning, observe the specific national and local requirements.
- Observe the accident prevention and conservation requirements in the country of use and at the installation site.
- Make no changes or modifications to the device that go beyond the scope of use specified in these instructions. Doing so will void the warranty.

Requirements for the installation site

Ensure that the following conditions are met at the installation site:

- Use the device in indoor locations only.
- The ambient temperature is between 10 and 40°C.
- The installation site is at altitudes under 2000 m.

- The maximum relative humidity is 80% at temperatures of up to 31°C (linear declining up to 50% relative humidity at 40°C).
- The device must always be protected against wetness and moisture. Under no circumstances may it be exposed to splashed water or condensate.
- Surge category II
- Soiling degree II

Requirements of cable for mains voltage and system components and installed lines

Use only cables and installed lines which meet the following requirements:

- Dielectric strength 30 V ... 260 V according to the nominal voltage (see specification plate)
- The cable ducts installed by Gebr. Heyl in the device have a clamping range of 4.5 mm – 10 mm. This means that the external diameter of the laid cable must remain within the range of 4.5 mm – 10 mm. If you use other ducts, the cable diameters must correspond to the ducts.
- The terminal strips on the circuit board require core cross-sections of between 0.08 mm² and 2.5 mm². This applies to single-wire and fine-wire cores with wire end ferrules without plastic collar. For fine-wire cores with wire end ferrules and plastic collar, the cross-section may be up to 1.5 mm². For single-wire cores, AWG28 – AWG12 can also be used.

Requirements for cable ducts

- The recesses in the housing are intended for M16 ducts.
- The ducts should have a smooth and rounded opening (to protect against bending and abrasion).
- Be careful to ensure securely fastened bending protection, which must be five times the length of the maximum cable diameter.
- The duct should include a strain relief that prevents slippage of the cable and that cannot be disengaged without a tool.
- You can order cable ducts from us as spare parts (Art. No. 13500). If you use another cable duct, the material must have a flammability rating of V1 or better.

During assembly

- Always disconnect the relevant system component from the power source before assembling the device or connecting it to the power supply or disconnecting it from the same. Prevent any inadvertent reactivation of the device.
- Only connect the device to the mains voltage as specified on the type plate.



- Observe the technical data and the environmental parameters.
- The connections for mains voltage and relay outputs must be laid separately from each other, to guarantee corresponding insulation between the cables. Accordingly, do not operate the device if the partition walls or terminal area covers are not present.

NOTE

Avoiding interference voltages

The MultiControl CT device requires stable and uninterrupted supply voltage. Where applicable, use a mains filter to shield the MultiControl CT device from interference voltages, which may be generated for example within the network by magnetic valves or large-scale engines. Never lay the connecting cables in parallel to mains cables.



Handling may cause damage or destruction of electrical components!

If you need to open the upper door, you should take the necessary safety measures to avoid electrostatic discharge onto the components (ESD safety).

Make sure you are earthed before opening the casing.

During operation

- **The device has no power switch.**
Use an external power switch to turn the unit on and off. The switch must be installed next to the device and must be marked as power switch for the device - for example with a label.
- Ensure that the maximum electrical load capacity of the switching outputs is not exceeded, particularly for inductive loads. The power supply for the user inclusive device is secured with a 4A fuse, which means the total of all loads must not reach 4A.
- In the event of any malfunctions, immediately switch off the MultiControl CT device and inform the service personnel. Never attempt to repair the MultiControl CT device yourself. Doing so will invalidate the guarantee. Repairs must be performed by authorized service personnel only.

During cleaning

- Only use a dry and lint-free cloth.

Malfunctions/repairing a defective device

- A defective device, regardless of the guarantee period, can be serviced only when the device is dismantled and the error is described. Make no changes or modifications to the device that go beyond the scope of use specified in these instructions. Doing so will void the warranty. Remove the power pack and send it back in the original packaging.
Before dismantling, the type of error must be noted (error number, error effect, log file of the SD card).
- Once a protective device has been triggered (safety fuse), initially try resolving the cause of error (e.g. by replacing a defective valve), before reactivating the protective device. Frequent triggering always signifies an error, which under certain circumstances may also damage the device.

During disposal

- Dispose of the device in accordance with the regulations of your country.

Operating requirements



- Only operate the device within the scope of parameters specified under "[Technical Data](#)".
- Careful handling of the device enhances the operational safety and the service life! With this in mind, perform a visual inspection of the device at regular intervals as follows:
 - Is the door of the device carefully closed?
 - Is the device excessively soiled?
- Problem-free operation is contingent on regular maintenance! Maintenance and care instructions can be found in the "[Servicing and maintenance](#)" section.
- Indications of problems can be found in the "[Error messages/troubleshooting](#)" section.

Delivery includes:

- 1 Multifunctional device MultiControl CT
- 1 Lithium battery, built-in
- 1 User manual
- 1 integrated measuring card, depending on the order

Service description

The MultiControl CT can optionally be used as a measurement device for conductivity or for the total dissolved solids TDS or as a controller of cooling circuits.

As a conductivity measurement device, you can use a suitable conductivity probe to monitor the conductivity in aqueous media and to regulate process water circuits.

As a control system you can implement desalination and dosing functions in cooling circuits.

The device has the features:

- Simplified menu-driven operation and programming via [backlit](#) graphic LCD.
- Alternatively, connecting a conductivity probe:
 - Inductive conductivity probe with integrated temperature sensor without pH-measurement with inserted [probe adaptor card](#).
 - Measuring converter as inductive conductivity probe when the [EC inductive/pH card](#) is used. The measuring converter transmits conductivity and temperature via two 20 mA interfaces. Additional pH measurement.
 - Conductive conductivity probe with PT100/PT1000 temperature sensor when [EC/pH card](#) is used. The temperature sensor can be connected as 2-, 3-, or 4-wire circuit. Additional pH measurement.
 - If pH measurement is available, a pH probe with temperature sensor/platinum sensor PT100 or PT1000 and 2-, 3-, or 4-wire circuit can be used.
- Five outputs (with neutral change-over contacts):
 - Three relays for the control of inhibitor and biocide dosing pumps, alternatively for a circulation pump.
 - One output to connect a motor or solenoid valve for desalination.
 - One [Fault signal output](#)
- Six potential-free inputs with adjustable polarity:
 - Water meter
 - [Stop/Standby](#)
 - flow monitor
 - Three level switches for biocides/inhibitor
- [Logging](#) on SD card for [measurement data](#) and [notifications/alarms](#) (with interim buffer for 100 measurement values and 50 notifications).
- Battery-supported clock
- Various diagnostic options:

- LEDs for display of input and switching states
- Displaying the states of all inputs incl. current inputs in the diagnostics menu
- Manual switching of all outputs
- [Logging of all status changes](#) on SD card
- [Import](#) and [Export](#) of settings (basic program data) with selectable filenames.
- [Firmware update](#) via SD card
- Features for integration into process controllers:
 - [Fault signal output](#) (neutral changeover contact)
 - Serial [RS232](#) interface to transfer measurement data and notifications/alarms
 - Input [Stop](#)
 - Optional [ADI plug-in card](#) with 2 x 20 mA current interfaces and second RS232 interface

Installation

Prior to installation



Risks resulting from incorrect installation!

MultiControl CT is protected against splash water and dust. High-pressure water and excessive dust will damage the instrument.

- Install MultiControl CT at a location where it is protected against high-pressure water, dust and aggressive substances – e. g. in a switch cabinet or on a suitable wall.

- Remove the Terminal box cover.

Assembling the MultiControl CT

- Secure the device with one of the supplied screws in a suitable position in the switching cabinet or on the wall.
- Secure the MultiControl CT with a screw in each case.

Connecting the power supply and devices



Risk of electric shocks during installation!

If the power supply is not disconnected prior to installation, it may result in physical injuries, destruction of the product or damage to plant parts.

- Disconnect the relevant plant parts before installing MultiControl CT.
- Only use tested cables with sufficient cross-sections for the connections.

Disconnecting device for the power supply

The unit has no power switch!

- Fit the MultiControl CT with a switch as a disconnecting device for the power supply. Use an appliance switch or a circuit breaker that meets the requirements of IEC 608947-1 and IEC 60947-3. The switch must be within easy reach of the user of the MultiControl CT and clearly marked as a disconnecting device for the MultiControl CT.

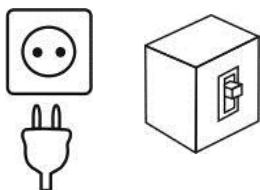

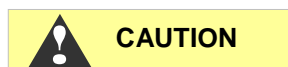

Observe ESD safety precautions! See the information on page 8



Installing the terminal compartment cover

For technical safety reasons, the terminal compartment cover must be put back in place immediately after connecting the mains voltage and the system components, since the terminal space houses cables that carry dangerous voltages. This helps prevent inadvertent contact with the terminals and contact between the individual lines that may carry different voltages and thus avoid the risk of a life-threatening electric shock.

Also ensure that the cables are not pinched when installing the terminal compartment cover!

Risk of damages caused by electromagnetic fields!

If the MultiControl CT or the connecting cables are installed parallel to power cables or in close proximity to electromagnetic fields, the instrument may be damaged or measurements may be erroneous.

- Always install measuring and control cables separately from power cables.
- Always earth the instrument.
- Protect the MultiControl CT against interference voltages – e. g. via a mains filter.
- Shield the instrument against strong electromagnetic fields.
- Refer to the rating plate for the appropriate power supply.
- Connect the power supply to terminals 1–3.

The following devices can be connected to the MultiControl CT:

- Various consumers, e.g. pumps, motors or solenoid valves
- Sensors
- Output devices

Motor valve with direct-current voltage

If a motor valve is used with direct-current voltage, observe the motor valve's documentation. An additional pole turning relay to reverse the direction of rotation must be used where applicable



Indicate external voltage on the relay contacts!

If you connect system components that do not operate using the device voltage, you can apply external voltages to the relay contacts. This external voltage cannot be switched off via the external mains switch.

There is a danger of electric shock!

Affix a warning to the device in this case (e.g. a sticker as shown left).

Power consumption

The maximum power consumption of all relay outputs shall not exceed 920 W (at 230V) / 4 A.

After installation

- Replace the terminal box cover.
- Tighten the screws at the terminal box cover.

Checklist for assembly and installation

1. Installation:
 - a. Outputs: Are the pumps and horn/alarm system connected?
 - b. Inputs: Is the level switch connected?
 - c. Sensors: Is the measuring converter connected to the plug-in card?
 - d. Plug-in card for measurement: Has the switch panel been configured?

2. MultiControl CT configuration:
 - a. Has the [polarity of the level switch and other inputs](#) been configured?
 - b. Has the level switch's function been checked in the [inputs diagnosis menu](#)?
 - c. Has the transfer of the sensor values been checked, or in the [inputs diagnosis menu](#) where applicable?
 - d. Has pump operation been checked in the [outputs diagnosis menu](#) (all switching relays)?
 - e. Is the SD card plugged in to [log the data](#)?

The MultiControl CT should now be ready for setting up the system parameters such as limit values and dosing intervals.

Additional recommendations:

NOTE

- Once you have made all the settings, export them to the SD card and to a second card, which is kept as a backup under lock and key. Should the settings be changed unintentionally, they can easily be restored.
 - Place the manual near to the device or place the manual as a PDF file on the SD card. Thus it is always at hand.
 - Archive the system circuit diagram and the system's schematic diagram. Even if you know your system well, our customer support does not know it and requires this documentation when you require support.
-

Operating features and connections

Operating features

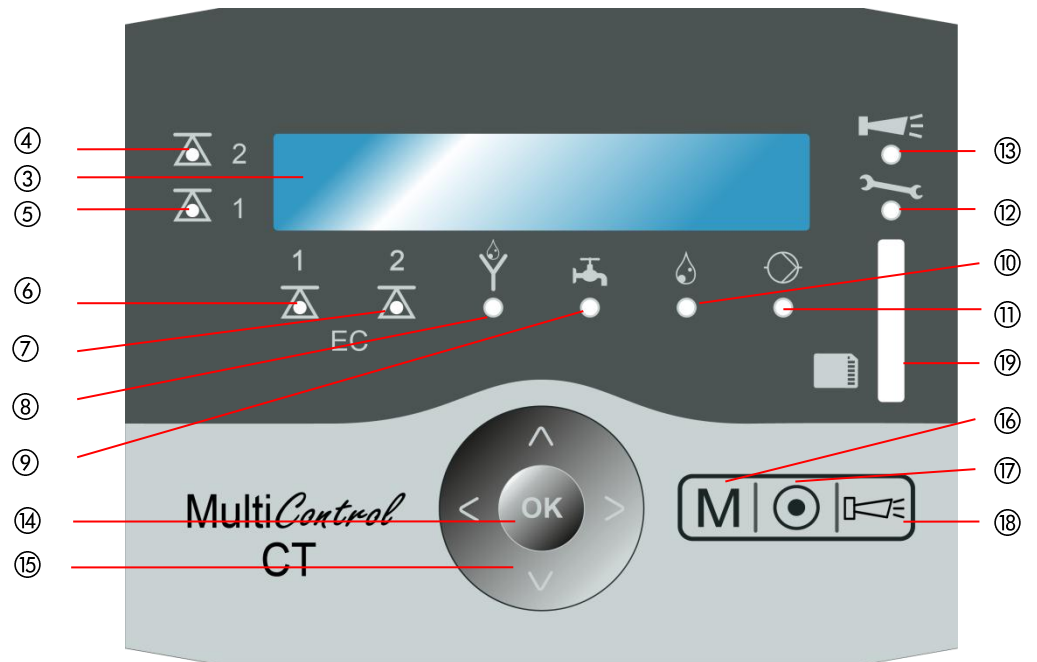

- ① At bottom: cable sleeves
- ② At right side: rating plate
- ③ Display
- ④ LED limit value 2
- ⑤ LED limit value 1
- ⑥ LED limit value EC 1
- ⑦ LED limit value EC 2
- ⑧ LED desalination
- ⑨ LED inlet
- ⑩ LED dosing
- ⑪ LED pump
- ⑫ LED service
- ⑬ LED alarm
- ⑭ „OK“ key
- ⑮ Arrow keys
- ⑯ „M“ key (menu)
- ⑰ „Basic program“ key
- ⑱ „Alarm“ key
- ⑲ Plug-in slot for SD card:
SD/SDHC card ≤32 GByte.
Formatting FAT/FAT32

Connections on the motherboard

Switching outputs 12V/3.3V LED Inputs Plug-in card slots

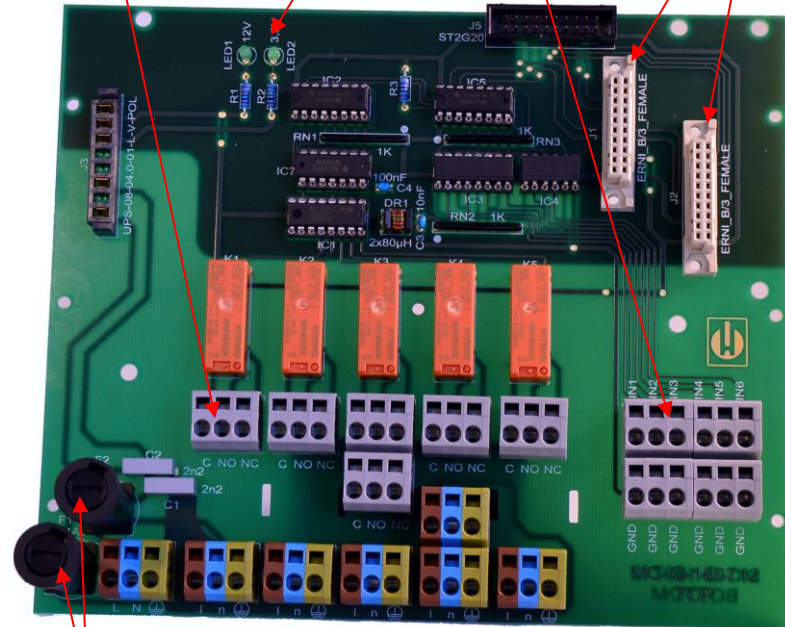

F1: Fuse 230V T4A (20x5 glass fuse)

F2: Fuse 230V T4A (20x5 glass fuse)

Refer to the terminal assignment in the following table (a sticker for the terminal assignment is located on the terminal cover of the Multi-Control CT). All switching outputs are isolated:

Terminals	Meaning
PE / N / L	MultiControl CT's power supply
n / l	Consumer's power supply
K1 - C / NO / NC	Programmable switching output for the inhibitor or circulation pump
K2 - C / NO / NC	Switching output biocide pump 1
K3 - C / NO / NC	Switching output biocide pump 2
K4- C / NO / NC	Switching output desalting valve
K5 -C / NO / NC	Switching output alarm
IN1	WM - water flowmeter for additional water
IN2	Level switch biocide 1
IN3	Level switch biocide 2
IN4	Level switch inhibitor
IN5	Flow monitor circulation pump
IN6	Standby input

Fuses on the power supply pack plug-in card

Multi-range power supply board 100 – 240V:

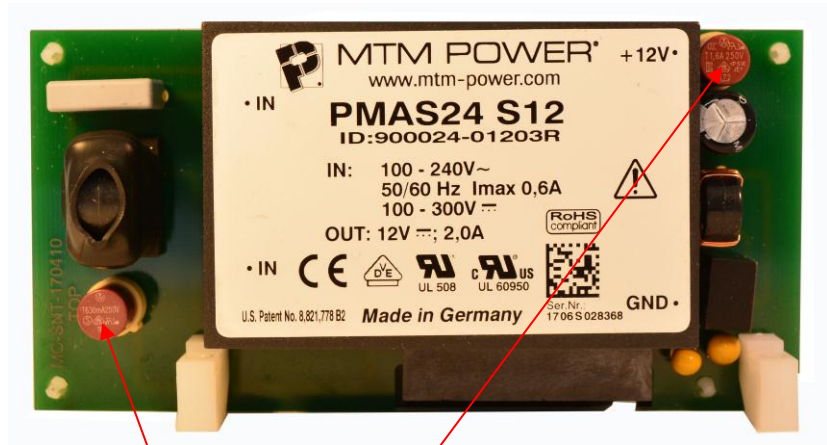

F2: Fuse T0,63A

F3: Fuse T1.6A

Art. no.
31618
31666

Power supply board 230 V:



F2: Fuse T0,16A

F3: Fuse T1.6A

Art. no.
31596
31666

Connections on the control board

Battery CR 2032 Reset button, Boot RS232, Sub D 9pol

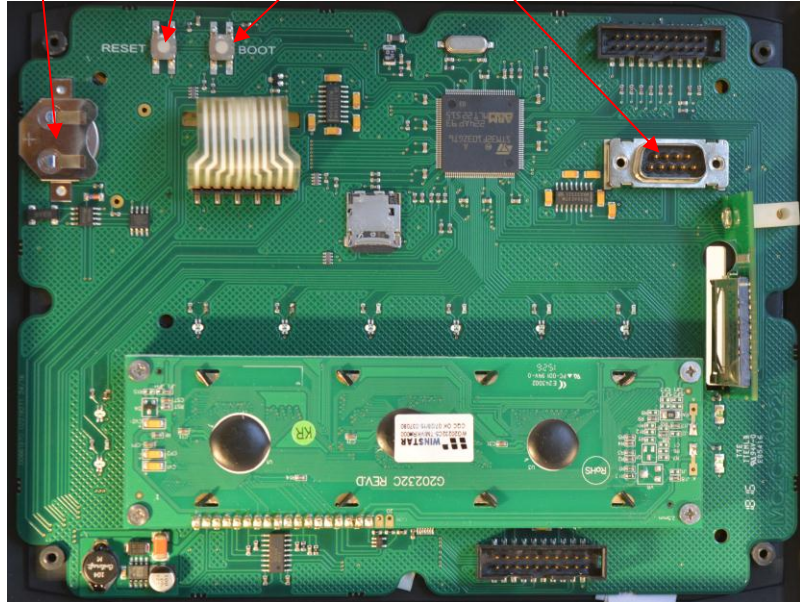

Control elements on the control board

- **Battery holder:** The battery holder houses a CR2032 lithium battery to retain the time setting even if the device is switched off.
- **RESET button:** To reset the controller, proceed as for switching on and off
- **BOOT button:** Only used when a menu-driven firmware update is not possible.
- **The micro SD card on the control board must not be removed!**



RS232 interface terminal assignment

1	2	3	4	5	
○	○	○	○	○	Sub-D 9 poles
	○	○	○	○	
6	7	8	9		

No.	Terminal designation	Function
2	RXD	Data reception
3	TXD	Output of measured values/alarms
5	GND	Ground

Plug-in cards

Connecting the plug-in card EC/pH

➤ Refer to the terminal assignment in the following table:

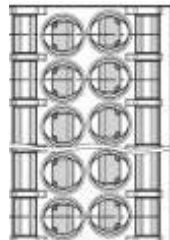

pH FORCE+	O 1	2 O	pH RTDIN+
pH FORCE-	O 3	4 O	pH RTDIN-
LF FORCE+	O 5	6 O	LF RTDIN+
LF FORCE-	O 7	8 O	LF RTDIN-
LF2 (in)	O 9	10O	LF1 (out)

- The conductive conductivity probe is connected to LF1/2.
- The two temperature sensors for conductivity and pH can be detected using a 2, 3 or 4 wire measurement. Both PT100 and PT1000 sensors can be used.
- The pH probe itself is connected to the BNC bush on the circuit board. This bush has a bayonet locking device. Ensure that the connection is locked.

Connecting the plug-in card EC inductive/pH

➤ Refer to the terminal assignment in the following table:

Circuit board (the connector's snap hook is on the left)

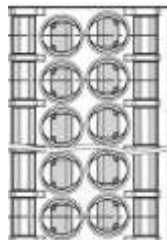

20mA Temp -	O 1	2 O	+24V
20mA Temp +	O 3	4 O	20mA LF +
20mA LF -	O 5	6 O	FORCE-
FORCE+	O 7	8 O	RTDIN-
RTDIN+	O 9	10O	GND

- The current interface of the inductive conductivity probe is connected to LF. If the probe has a temperature output, it is connected to Temp. If no temperature sensor is available, the temperature can be entered manually.
- The pH probe itself is connected to the BNC bush on the circuit board. Ensure that the BNC connector's bayonet locking device is locked.
- 24V / 0.2A are available for the power supply of a measuring converter.
- The temperature sensor of the pH probe is connected to RTDIN+ and RTDIN- (and GND as shielding). A PT100 or PT1000 sensor can be connected. 2, 3 or 4 wire measure-

ment is possible. To do so, the switch panel on the circuit board must be configured according to the following section.



Measuring error if the temperature sensor is incorrectly set

- The temperature sensor’s default setting is PT100 2 wire measurement. If you use a PT1000 sensor or a 3 or 4 wire measurement, the switch setting must be adjusted as otherwise a large measuring error will inevitably occur!

Switch panel

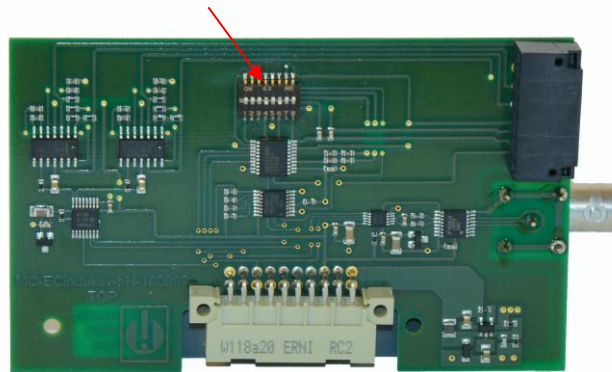

The switch panel must be configured as follows (same view as on circuit board at the top):

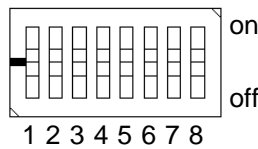

Type PT-Sensor	Measuring method (2..4 wire)	Switch configuration "on" for switch
PT100	2	1 2 3 7 8
PT100	3	1 2 3 6
PT100	4	2 3
PT1000	2	1 4 5 7 8
PT1000	3	1 4 5 6
PT1000	4	4 5

Only for 3 wire measurement: Activate the option
 3 wire
 in the menu
 BASIC PROGRAM ⇒ Temperature
 ⇒ CD temp. sensor ⇒ Sensor connection.

Connecting the ADI plug-in card

- The terminal assignment is shown in the following table:

Board (snap hook of the connector is on the left)

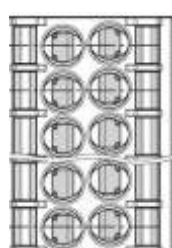

RS232 RxD	O 1	2 O	GND
RS232 TxD	O 3	4 O	
IOUT1-	O 5	6 O	
IOUT1+	O 7	8 O	+12V
IOUT2-	O 9	10O	IOUT2+

- The ADI card provides two isolated 0/4... 20 mA current outputs and an additional RS232 interface.
- The load must not exceed 500 Ohm. The maximum voltage between Iout+ and Iout- is 15V.
- The inductive BKEX probe can also be connected to the RS232 interface. For terminal assignment, see section BKEX probe.
- However, only one LF probe can be connected, i.e. either the BKEX probe with probe adaptor or ADI card or another inductive or conductive probe using the EC/pH or EC inductive/pH card..

Probe adaptor card

- The board is used exclusively for connecting the inductive BKEX probe as the only conductivity probe in the system.
- The card is mechanically coded and can be inserted only into the left slot
- The MultiControl recognises the probe automatically. Temperature and conductivity can be displayed
- The inductive conductivity probe is connected to the terminals of the board. The terminal assignment is shown in the following table:

Board (snap hook of the connector is on the left)

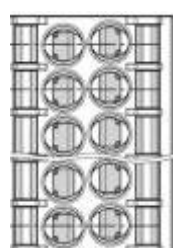

RS232 RxD <i>Orange</i>	O 1	2 O	GND <i>Black</i>
RS232 TxD <i>Brown</i>	O 3	4 O	
	O 5	6 O	
	O 7	8 O	+12V <i>Red</i>
	O 9	10O	

- The cable colours of the probe cable are printed in italics.
- The probe is wear- and maintenance-free.

Connection example

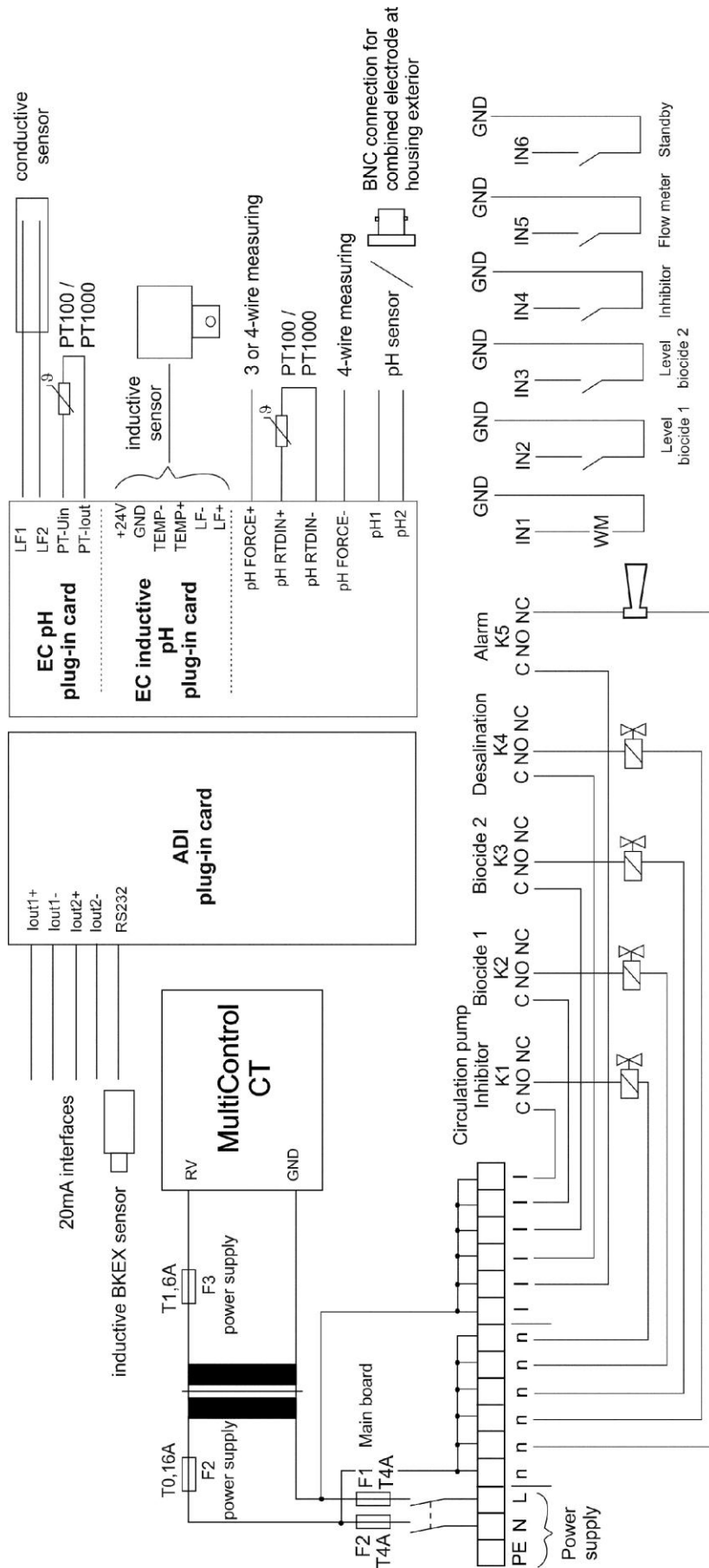

Connecting the measuring converters

Jumo CTI-500

Follow the procedure described in the Jumo probe user manual if the probe with display is used.

There is little information on the CTI-500 without display/keyboard in the manual. Therefore the connection is explained here.

The following is necessary for the configuration:

- Jumo PC interface with converter USB/TTL (Jumo parts no. 00456352)
- Configuration software Jumo parts no. 00447634 (available as a free trial version for 30 days)

The following steps must be carried out:

1. Unzip the CD or installation archive and install the driver for the USB TTL adapter (adapter must not be plugged in). It is a 'FTDI driver' V 2.8.14. Please check whether the version is correct. Newer drivers may be available as this driver is relatively old. These may, however, not be suitable.
2. After installation: Attach the TTL/USB adapter to the USB. Read off and note the COM port in the device manager. You will require this later for the software.
3. Start the Jumo installation program or insert the CD of the Jumo CTI probe and install the software.
4. Supply the probe with 24V (1+, 2-). When switching on, the LEDs K1 and K2 must light up for a few seconds.
5. Switch off 24 V.
6. Use the abovementioned PC interface with converter USB/TTL. Connect the TTL cable which consists of RJ45 connector (plug in to the blue adapter); attach the pin connector to the 4-pin adapter. Attach the adapter to the open probe during SETUP. Due to the mechanical coding there is only one option.
7. Switch on the probe's power supply; USB is plugged in. The yellow LED on the USB/TTL RJ45 must light up.
8. Start the installed Jumo software under point 3; data transfer (press connect).
9. The 'Connection setup wizard' window appears:
 1. Enter the probe's name under Info (for identification in the list that appears later)
 2. Press next
 3. Communication interface is grey; the serial interface is selected
 4. Press next
 5. 'Check COM ports' appears briefly
 6. In the settings for the serial interface select:
Connected to <listed COM port see above>

Transfer rate: 9600 baud (default)

Control signal: RS232 setup interface (TTL), default

7. Press next
 8. Device address: 1 (must remain 1!), press next
 9. Confirm the overview with Finish.
 10. Connection is established and should work. When data are transferred, the green LED on the RJ45 connector flashes.
 11. The wizard is closed. Now a table appears below with date, time, name, value. It is constantly updated. These are already data from the probe.
 12. Setup: File, select New
 13. A tree structure appears. Double-click on the names to open the window. The probe data is entered there. Interesting are:
 1. Interface configuration in analogue output conductivity
 2. Interface configuration in analogue output temperature
 3. Measuring range in analogue input conductivity
 4. Measuring range in analogue input temperature
 14. After all settings have been made, select 'Data transfer to the device' in the menu.
 15. Save settings as file, Save
10. Program can be terminated.
11. Standard settings are: 4-20 mA interface, temperature scaling 0..150°C, range 2 0-1000 µs/cm.
12. The measuring ranges for conductivity and temperature must of course be configured in an identical manner in the probe and in the MultiControl CT!
13. In addition, the displayed temperature can be selected between different sensors. For the Jumo probe's temperature sensor, select in the menu:
- ```
BASIC PROGRAM ⇒ TEMPERATURE ⇒ TEMP. Display
⇒ LF
```
14. Recheck if the probe's measurement values are identical in the Jumo software and for the MultiControl CT, and, where applicable, recheck if the transfer of the currents is working correctly using the [Diagnosis menu](#) under IN mA.

## Kuntze Neon LF

The Neon LF operates as a measuring converter, which controls the inductive probe Kuntze IL15 and the built-in NTC and passes on the measurement values to the MultiControl CT via two 20 mA interfaces. If the Neon LF comes with the 24V option, it can be supplied by the MultiControl CT. A 6 wire control cable is required for connection:

| Description              | Terminal Neon LF       | Connector card<br><a href="#">EC inductive/pH</a> |
|--------------------------|------------------------|---------------------------------------------------|
| <b>20mA conductivity</b> | 30 (analog output 1 +) | 7 (LF +)                                          |
|                          | 31 (analog output 1 -) | 5 (LF -)                                          |
| <b>20mA temperature</b>  | 32 (analog output 2 +) | 3 (Temp +)                                        |
|                          | 33 (analog output 2 -) | 1 (Temp -)                                        |
| <b>Power supply</b>      | 24VDC +                | 2 (+24V)                                          |
|                          | 24VDC -                | 6 (GND)                                           |

- For the Neon LF the assignment of the current outputs must be set in the menu 'On/Off' ⇒ 'mA Off 1'
  - Assignment: 'mS/cm'
  - Range: 0 - 20 mA or 4 - 20 mA, corresponding to MultiControl CT in the menu. If you would like to monitor the sensor connection, select 4-20 mA for both devices so that the MultiControl CT can produce the error 'Sensor interrupted' if there is no current flow.
  - 22 mA alarm: Off. Set range min/max according to the probe and the de-sired range. Standard 0 – 2 mS/cm
  - The MultiControl CT must be configured accordingly, in the menu

```
BASIC PROGRAMM ⇒ INDUCTIVE PROBE ⇒
MEAS. RANGE CD
2000µS/cm *
```

- In the menu 'On/Off' ⇒ 'mA Off 2'
  - Assignment: '°C'
  - Range: 0 - 20 mA or 4 - 20 mA, corresponding to MultiControl
  - 22 mA alarm: off
  - Set range min/max according to the probe and the de-sired range. Standard is 0 – 100°C
  - The MultiControl CT must be configured accordingly, in the menu

```
BASIC PROGRAMM ⇒ INDUCTIVE PROBE ⇒
Min. temperature 0.0 °C
Max. temperature 100.0 °C
```

- In addition, the displayed temperature can be selected between different sensors. For the LF probe's temperature sensor, select in the menu:

BASIC PROGRAM ⇒ TEMPERATURE

⇒ TEMP. TO SHOW ⇒ CD

- Check whether Neon LF and MultiControl CT display (almost) the same measurement values. Since the transfer takes place via the current interface in a similar manner, slight deviations in the displays are possible. Check if the transfer of the currents is working correctly using the [Diagnosis menu](#) under IN mA.

## BKEX probe to probe adaptor card or plug-in card ADI

- The card is mechanically coded and can be inserted only into the left slot
- The MultiControl recognises the probe automatically. Temperature and conductivity can be displayed
- The inductive conductivity probe is connected to the terminals of the board. The terminal assignment is shown in the table on page 22:
- The cable colours of the probe cable are printed in italics.
- The probe is wear- and maintenance-free.
- For an easy testing of the probe, a resistor can be looped through the measuring head (through the coil in the probe) and shorted. The following uncompensated measured values are expected:

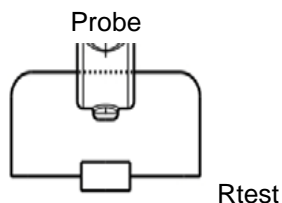

| Rtest | measured value                            |
|-------|-------------------------------------------|
| 10kΩ  | 455μS                                     |
| 1kΩ   | 4.55mS                                    |
| 100Ω  | 45.55mS ( only for measuring range 200mS) |

The compensation of the temperature influence is set in [temperature compensation](#).

The sensitive part of the measuring cell must not rest on or touch a surface. Otherwise, the measured value will be distorted!

The loop may consist of only one turn!

## Other measuring converters

The conductivity and optional temperature measurement signals must be provided as isolated 0-20 mA or 4-20 mA current signals.

Any control cable (wire cross-section max. 0.5 mm<sup>2</sup>) can be used for the connection. Connect the cable according to the [terminal assignment of the EC inductive/pH card](#).

Set the scaling of the current signal on the measuring converter and MultiControl CT in the same way.

Check if the transfer of the currents is working correctly using the [Diagnosis menu](#) under IN mA.

## Commissioning

After you have mounted the device and the connections of the plug-in card and the motherboard, you can optionally insert an SD card.

### Mounting the SD card (optional)

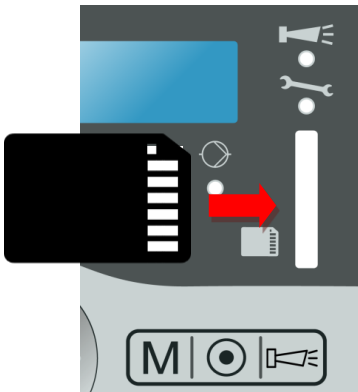

- Slide the SD card into the slot provided in the front panel (SD card's contact row on the right)
- Gently press in the SD card until it audibly clicks and locks into position.
- The process of mounting the SD card is now complete.

Further information on possible errors is included in the section [Error messages/troubleshooting](#). How and whether these errors are shown can be configured in the [Alarm/message](#) menu.

### Switching on/off the MultiControl CT

- Connect the MultiControl CT to the power supply. The display lights up and the start message appears.

### Calibrating the probes

In order to ensure accurate readings, all measuring probes used must be calibrated. The procedure is explained in chapters [Calibrating the pH probe](#) and [Calibrating the CD \(conductivity probe\)](#).

## Menu structure

### Call menu



- Press the „M“ key.  
The basic menu appears.

### Select menu

The following menus can be selected in the basic menu:

| Menu          | Functions                                                                                                                                      |
|---------------|------------------------------------------------------------------------------------------------------------------------------------------------|
| Service       | Request and change current MultiControl CT settings and statuses. For access you will <b>not</b> need a password in the 'Factory setting' menu |
| Basic program | Change settings or define values, enter plant data and parameters.<br>The menu is password protected.<br>This menu is for programming data.    |
| Information   | Display current settings from the "Basic program" menu. Access is <b>not</b> password protected.<br>This menu is for checking data.            |

- Press the arrow keys  $\Delta$  or  $\nabla$  to select the desired menu. Continue to press the keys to scroll up or down.  
The selected menu is displayed in capital letters in the first line of the display.
- Press the **OK** button.
- The selected menu opens. The menu item appears in the first line in capital letters.
- The changes in the service and basic program menus are only effective and saved when you exit the menu.

### Navigate to the desired menu item or input area

- Press the arrow keys  $\Delta$  or  $\nabla$  to select a menu item. Continue to press the keys to scroll up or down.
- Press the **OK** button.
- The menu item displayed in the second line is selected and now appears in capital letters in the first line. The submenu or the input area is displayed.

## Return to the higher order menu level



- Press the **M** button.  
The higher order menu level is displayed.

## Enter/change values

Only in the `Basic` program and in some menu items in the `Service` menu is it possible to enter or change values. Active menu items are indicated via a tick, inactive menu items via a minus sign.

- Change to the desired input area as described in the previous section.  
The first or active digit of the value you can change flashes.
- Press the  $\nabla$  key to reduce this value or the  $\triangle$  key to increase this value.  
The changed value is displayed.
- Press the  $\triangleleft$  or the  $\triangleright$  key to move to the previous or next digit respectively and to reduce or increase the value as desired.
- Press the **OK** button to confirm the displayed value.  
The value is saved. No inverse numbers are now displayed.

## Exit menu



- Press the **M** button several times to access the basic menu or to go to the operating display.

### NOTE

---

If a button is **not** pressed for 2 minutes, the instrument automatically exits the menu and the operating display appears.

---

## Time and date

MultiControl CT has an integrated clock, which continues to run even when the instrument is switched off – as long as the battery is not flat. To set the time, proceed as follows:

- Select and confirm  
`SERVICE` ⇒ `Time date` ⇒ `hh:mm dd.mm.yy`.  
The current time and date are displayed.
- To alter the time and date, press the **OK** button.
- Use the arrow keys  $\triangleleft$  $\triangleright$  $\nabla$  $\triangle$  to select and change each digit of the time and date.
- To save the time and date, press the **OK** button.

SERVICE  
Time Date

```
TIME DATE
Automatic ✓
```

- To set the clock automatically for summertime and wintertime select `Automatic` ✓.  
If a tick appears, the clock is automatically set for summertime and wintertime; if a dash appears, the clock is not automatically set for summertime and wintertime.
- Use the cursor keys  $\Delta$   $\nabla$  and **OK** to change the setting.
- The time format can be set to `day/month/year dd.mm.yy` or to the US format `yy/mm/dd`.

## Display number and date of the software

The number and date of the MultiControl CT software can be retrieved as follows:





```
SOFTWARE VERSION
FW: 200M001 15.08.12
```

- Select and confirm `INFORMATION` ⇒ `Software version`.  
The number and date of the software are displayed.
- Select and confirm `INFORMATION` ⇒ `Serial number`.  
The serial number of the instrument is displayed.



# Operation

## Key functions

| Key                                                                                                    | Function                                                                                                                                               |
|--------------------------------------------------------------------------------------------------------|--------------------------------------------------------------------------------------------------------------------------------------------------------|
|  <b>OK</b>            | <ul style="list-style-type: none"> <li>• Acknowledge input</li> <li>• Trigger functions</li> </ul>                                                     |
| <b>Arrow keys</b><br> | <ul style="list-style-type: none"> <li>• Menu navigation</li> <li>• Input of numerical values and programming data</li> </ul>                          |
|  <b>Menu</b>          | <ul style="list-style-type: none"> <li>• Call menu</li> <li>• Call higher order menu (back)</li> </ul>                                                 |
|  <b>Time</b>          | <ul style="list-style-type: none"> <li>• The date and time are displayed for a few seconds.</li> </ul>                                                 |
|  <b>Alarm</b>        | <ul style="list-style-type: none"> <li>• Switch off alarm signal (the fault display can only be deleted once the fault has been eliminated)</li> </ul> |

## Display

The operating display appears after switching on the instrument. If an error occurs, the display switches to the respective error message. Furthermore, the display shows the menu and enables programming of MultiControl CT.

The graphical backlit display has a resolution of 202x32 dots, corresponding to two lines, each with 25 digits.

### Operating display

The display shows the temperature of the fluid on the top left at the selected sensor (in the conductivity or pH probe) in the normal state, the pH value on the bottom left and the conductivity in  $\mu\text{S}/\text{cm}$  or the total dissolved solids in ppm on the right.

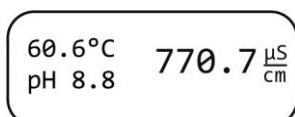

### Signal lamps

All signal lamps are three-coloured (green/orange/red) except for the alarm lamp (red only) and the maintenance lamp (yellow only) (for the position of the LEDs see page 16). The meaning of the lamps and colours are:

- LV2: Red indicates that the limit value for temperature has been exceeded

- LV1: Red indicates that the limit value for the pH value has been exceeded
- EC1: Red indicates that the limit value for the first conductivity limit value has been exceeded
- EC2: Red indicates that the limit value for the second conductivity limit value has been exceeded
- Desalination: Green if the desalting valve is active
- Water tap: Flashes green for approx. 400 ms, if the water meter counts pulses, i.e. water flows in the inlet.
- Droplet: Lights up green. Common display of the active metering of biocide1, biocide2 or inhibitor.
- Pump: Green if circulation pump is running.
- Maintenance: Yellow if maintenance period has elapsed
- Alarm: Red for an alarm where the message type is set to 'Message' or 'Alarm signal'.

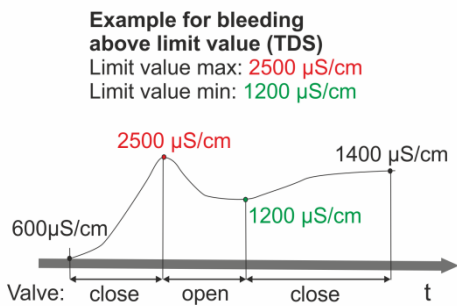

**Example for bleed mode (TDS)**  
 Time of dosing: 22:20  
 Pre-bleeding: 20 min for dosing  
 Duration (biocide dosing): 5 min  
 Locking: 180 min

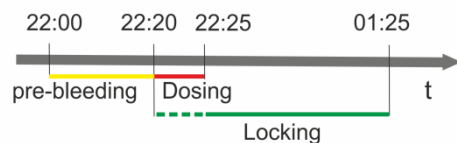

**Example for bleed mode (TDS)**  
 Time of dosing: 22:25  
 Pre-bleeding: 20 min for dosing  
 Duration (biocide dosing): 5 min  
 Locking: 180 min



## Function characteristics of the controller for cooling circuits

### Desalination function

The desalination valve opens when the upper limit value is exceeded. However, this is only possible when metering does not occur and there is no desalination lock. If the lower limit value is not achieved, the desalination valve closes again. It is possible to monitor the maximum desalination duration.

### Metering function – Solenoid valve

If the entered interval has expired or the set weekday is reached, a metering valve, e.g., opens at the set time for the set duration. At the end of metering, the locking time is started while desalination is prevented. This is only possible once the locking time has expired. It is possible to select a time-limited pre-bleeding before the metering.

### Metering function – Motor valve

The process is the same as described under “Metering function - Solenoid valve”.

The metering begins once the configured [Closing time of the motor valve](#) has elapsed.

## Basic program menu

### NOTE

The operating menu varies depending on the settings. For this reason, it is noted in a further text, if a menu option is only available with a certain setting.

MultiControl CT can be configured in the “Basic program” menu. If you have assigned a password, you must enter the password before you can call up the basic program. In the delivery state, you do not need a password to call up the basic program.

### Select mode

Select whether the instrument should be used as a measuring instrument or desalination controller.

- Select and confirm BASIC PROGRAM ⇒ Mode.
- Use the arrow keys to select the desired mode.
- Press the **OK** key.
- If an asterisk appears after the mode on the display, the alarm is activated.

```
MODE
Bleed CD *
```

```
MODE
Bleed TDS *
```

### Set the factor for measuring the TDS

If the mode Bleed TDS has been selected, a factor can be entered for the TDS measurement (0.40 ... 1.00).

- Select and confirm BASIC PROGRAM ⇒ TDS Factor.
- Enter the factor and confirm this with the OK button.

The factor is calculated from the correlation between electrical conductivity and TDS by the following formula:

$$\text{TDS (ppm)} = \text{factor} * \text{electrical conductivity } (\mu\text{S/cm})$$

In dilute solutions you can calculate with a factor of approx. 0,5. To make an exact calculation you need to analyze a water sample.

```
TDS FACTOR
 0,40
```

### Set the desalination function

A motor valve or a solenoid valve (desalination valve) can be connected to the output K4 for desalination.

- Select and confirm BASIC PROGRAM ⇒ Bleed function.
- Use the arrow keys to select the desired valve:
- Press the **OK** key.
- If a star appears after the valve on the display, the valve is activated.
- Press the **OK** key to accept the setting.

```
BLEED FUNCTION
Motor valve *
```

```
BLEED FUNCTION
Solenoid valve *
```

BLEED FUNCTION  
Close time 120s

### Closing time

Enter the time that the selected valve requires to close. A time up to 300 s/5 minutes can be set. The factory setting is 120 s.

BLEED FUNCTION  
Max. duration 1h

### Max. desalination duration

Monitoring of the maximum desalination duration (0...99 hours) can be set here. Monitoring does not occur if 0 hours is set.

## Define dosing

### Biocide 1 / 2

The following settings apply to biocide 1 and biocide 2 in the same way.

#### Dosing

BIOCIDE 1/2  
Dosing ✓

Here the dosing can be completely switched on or off. If an ozone system is used for disinfection, the dosing of biocides is not required. In this case, switch off the dosing of biocide 1 and 2.

Additional settings can only be made if dosing is activated by ✓ .

#### Start

Select here whether metering should be executed after a certain number of days or on specific weekdays.

START  
every n days \*

➤ Select and confirm  
BASIC PROGRAM ⇒ Dosing ⇒ Biocide 1/2  
⇒ Start.

➤ Use the arrow keys to select the desired time period:

➤ Press the **OK** key.

➤ If an asterisk appears after the time period on the display, this time period is activated.

START  
On weekdays \*

#### Interval

You can enter the number of days (01 ... 99 days) or the individual weekdays for the time period selected under Start.

When every n days has been selected:

INTERVAL  
All 10

➤ Select and confirm  
BASIC PROGRAM ⇒ Dosing ⇒ Biocide 1/2  
⇒ Interval.

➤ Press the **OK** key.

➤ Use the arrow keys to enter the desired days until the next metering.

➤ Press the **OK** key to accept the setting.

```
INTERVAL
On days _ _ _ _ _
```

When On weekdays has been selected:

- Select and confirm  
BASIC PROGRAM ⇒ Dosing ⇒ Biocide 1/2  
⇒ Interval.
- Press the **OK** key. The weekday selection is displayed, beginning with Sunday.
- Press the **OK** key. The cursor appears.
- Select the desired weekday with the arrow keys ◀▶ and activate (✓) /deactivate (-) the dosing with the arrow keys ▲▼.
- Press the **OK** key to accept the setting.
- Exit the menu with the **M** button.

```
BIOCIDE 1/2
Start time 23:15
```

### Start time

Enter the time at which dosing should start.

```
BIOCIDE 1/2
Dosing duration 20min
```

### Dosing duration

Enter the metering duration (01 ... 99 min).

```
BIOCIDE 1/2
Locking 180min
```

### Locking

Enter the time during which desalination should not take place after metering (000 ... 999 min).

```
BIOCIDE 1/2
Pre-bleeding 000m
```

### Pre-bleeding

Enter the duration of the pre-bleeding (000 ... 999 minutes).  
000 means no pre-bleeding.

```
BIOCIDE 1/2
Control -
```

### Control

Switch on the level monitoring control system if you wish to monitor the filling level of the biocide 1/2 dosing tank. For this purpose, a level switch must be connected to IN2 / IN3. Monitoring is switched off for the factory setting.

### Output K1

Here the output K1 can be completely switched on or off. Activate this output if you wish to monitor the dosing of an inhibitor or if you wish to control a circulation pump.

```
OUTPUT K1
Output active ✓
```

- Select and confirm  
BASIC PROGRAM ⇒ Dosing ⇒ Output K1  
⇒ Output active ✓
- If a tick appears on the display, the output K1 is activated, if a minus sign appears on the display, the output K1 is not activated.
- Press the **OK** key to accept the setting.

|                          |
|--------------------------|
| OUTPUT K1<br>Inhibitor * |
|--------------------------|

### Inhibitor

You can control the dosing of an inhibitor via the output K1. Select the entry `Inhibitor` to configure additional settings.

- Select and confirm  
`BASIC PROGRAM ⇒ Dosing ⇒ Output K1`  
`⇒ Inhibitor *`  
 An asterisk indicates that inhibitor has been selected.
- Press the **OK** key to accept the setting.

### Inhibitor dosing mode (if `Inhibitor` was selected)

Once you have selected `Inhibitor`, you can configure additional settings for the inhibitor's dosing.

- Select and confirm  
`BASIC PROGRAM ⇒ Dosing ⇒ Output K1`  
`⇒ Inhib. dosage mode`
- Configure the desired settings for the dosing:

### Per pulse

Select this setting if the dosing is to be controlled according to pulse.

An asterisk indicates that `Per pulse` has been selected.

The configuration option `Duration/pulse` is now available.

#### Dosing duration / pulse

Enter the dosing duration per pulse (01 ... 99 s).

### By Quantity

Select this setting if the dosing is to be controlled according to quantity.

An asterisk indicates that `By quantity` has been selected.

The configuration option `By quantity setting` is now available.

#### Dosing by quantity

Once you have selected `By quantity` you can configure additional settings for the quantity of water, dosing time and water meter type under this menu option:

#### Watermeter type

Select the water meter type which you are using (1 l/pulse ... 1000 l/pulse).

#### Water quantity

Enter the quantity of water to be dosed (001 ... 999 m<sup>3</sup>).

#### Dosing time

Enter the time to be dosed (01 ... 99 s).

**Control**

Switch on the level monitoring control system if you wish to monitor the filling level of the inhibitor dosing tank. For this, a level switch must be connected to input IN4. Monitoring is switched off for the factory setting.

**Circulation pump**

You can control a circulation pump via the output K1. Select the entry circulation pump to configure additional settings.

## ➤ Select and confirm

BASIC PROGRAM ⇒ Dosing ⇒ Output K1  
⇒ Circulation pump

An asterisk indicates that the circulation pump has been selected.

|                                 |
|---------------------------------|
| OUTPUT K1<br>Circulation pump * |
|---------------------------------|

**Circulation setting** (if Circulation pump is selected)

Once you have selected Circulation pump you can configure additional settings for the circulation pump.

## ➤ Select and confirm

BASIC PROGRAM ⇒ Dosing ⇒ Output K1  
⇒ Circulation setting

## ➤ Configure the desired settings:

**Start**

In the submenu, select whether the circulation pump is constantly pumping (Always) or at certain intervals (Every n days, On weekdays) and how long the pump is to run under Duration.

The setting works according to the same principle as the bio-cide/inhibitor metering.

**Control**

The circulation pump is monitored with a flow monitor connected to IN5. Dry running of the circulation pump is thus prevented. Monitoring is switched off for the factory setting.

## Change cell constant

This menu option can only be selected if a conductive conductivity card is inserted into the device.

```
CELL CONSTANT
C= 1.00/cm
```

- Select and confirm  
BASIC PROGRAM ⇒ CELL CONSTANT.  
The current cell constant appears on the display.

To alter this cell constant:

- Press the **OK** key.
- Enter the cell constant of your conductivity probe (range 0.01-9.99) and confirm it and confirm with **OK**.

## Inductive probe

This menu option can only be selected if an inductive conductivity card is inserted into the device.

### NOTE

Please note that all settings in the probe or in the measuring converter and in the MultiControl must be identical, otherwise scaling errors and incorrect measurements as a result of these will occur!

## Measuring range CD

The measuring range or the scale for the conductivity is adjustable within wide limits between 100  $\mu\text{S}/\text{cm}$  and 5000  $\text{mS}/\text{cm}$ . The maximum corresponds to an input current of 20 mA.

- Select and confirm  
BASIC PROGRAM ⇒ Inductive Probe  
⇒ Meas. range CD
- Configure the desired setting.

```
INDUCTIVE PROBE
Meas. range CD
```

```
MEAS. RANGE CD
1000 $\mu\text{S}/\text{cm}$ *
```

## Interface type CD

Defines the parameters of the two 20 mA current interface inputs with which conductivity and temperature are transferred from the sensor/measuring converter to the MultiControl CT.

- Select and confirm  
BASIC PROGRAM ⇒ Inductive probe  
⇒ Signal type CD  
0-20 mA: If this menu option is activated, currents from 0 to 20 mA are evaluated as measurement signals.

4-20 mA: If this menu option is activated, currents from 4 to 20 mA are evaluated as measurement signals.

The maximum load of 500  $\Omega$  must not be exceeded!

```
SIGNAL TYPE CD
0-20 mA *
```



**Min. temperature**

Set the scaling of the temperature measuring range here.

```
INDUCTIVE PROBE
Min.temperature 0.0°C
```

- Select and confirm  
BASIC PROGRAM ⇒ Inductive probe  
⇒ Min. temperature
- Set the temperature corresponding to the minimum permissible current (0 or 4 mA).

**Max. temperature**

Set the scaling of the temperature measuring range here.

```
INDUCTIVE PROBE
Max.temperature 88.0°C
```

- Select and confirm  
BASIC PROGRAM ⇒ Inductive probe  
⇒ Max. temperature
- Set the temperature corresponding to the maximum permissible current (20 mA).

**Interface type temperature**

Defines the parameters of the 20 mA current interface, with which the temperature is transferred.

```
INDUCTIVE PROBE
Signal type temp.
```

```
SIGNAL TYPE TEMP
4-20 mA *
```

- Select and confirm  
BASIC PROGRAM ⇒ Inductive probe  
⇒ Signal type temp.
- Configure the desired setting.

**Define limit values**

With the limit values, you define which conductance starts and ends the desalination.

**Define min. limit value**

Define the lower (minimum) limit value under menu LIMIT VALUE MIN.

```
LIMIT VALUE MIN.
Min. CD 10µS/cm
```

- Select and confirm  
BASIC PROGRAM ⇒ Limit value min.  
The current lower limit value appears on the display.
- Press the **OK** key and enter the desired lower limit value.
- Confirm with **OK**.

### Define max. limit value

Define the upper (maximum) limit value under menu LIMIT VALUE MAX.

```
LIMIT VALUE MAX.
Max. CD 100µS/cm
```

- Select and confirm  
BASIC PROGRAM ⇒ Limit value max.  
The current upper limit value appears on the display.
- Press the **OK** key and enter the desired upper limit value.
- Confirm with **OK**.

#### NOTE

### Selecting the limit values

The upper limit value must be greater than the lower limit value, but smaller than the measuring range.

```
LIMIT VALUE MIN.
Test time 10s
```

```
LIMIT VALUE MAX.
Test time 30s
```

### Set test time

Enter the length of time which the limit value must be continuously exceeded or fall below before the relay switches. (00 ... 99 seconds).

At 0 seconds the relay switches immediately

The test times can be set separately for Limit value min. and Limit value max.

### Temperature

Configure the settings for the temperature sensor used here.

The temperature for the display can be selected here if a pH electrode with a temperature sensor is used and an inductive probe which also transmits the temperature. The nearest sensors are used for the calculation (i.e. the temperature sensor on the pH probe for the pH value and the temperature sensor in the LF probe for conductivity).

### Selecting the unit

You can choose between the display in Fahrenheit and Celsius.

```
UNIT
Display °C *
```

- Select and confirm  
BASIC PROGRAM ⇒ Temperature ⇒ Unit
- Select the desired unit Display °C or Display °f and confirm with **OK**.

### Temperature display

Select under

BASIC PROGRAM ⇒ Temperature ⇒ Temp to show the probe for the display of the temperature measurement value. You can display the following temperatures:

```
TEMP. TO SHOW
CD *
```

- Manually configured temperature
- Temperature at the conductivity probe

- Temperature at the pH probe

### Temperature alarm

#### Entering the minimum temperature and the minimum test time

If this temperature is falling below the limit, the error message Alarm temp. below appears on the display and a fault message is output at output AL.

```
TEMP. ALARM
Min. temp. 10°C
```

- Under BASIC PROGRAM ⇒ Temperature ⇒ Temp. alarm ⇒ Min. temp. enter and confirm the temperature at which the alarm is to be triggered if this temperature is below.

```
TEMP. ALARM
Min. test time 10s
```

- Under Min. test time enter the duration of the temperature measurement (00 – 99s). You can exclude short temperature fluctuations with a longer test time before an alarm is displayed.
- Confirm with **OK**.

#### NOTE

If “0°C” has been entered here, the temperature is not monitored. An alarm will not sound even if the temperature of the medium increases rapidly.

#### Entering the maximum temperature and maximum test time

If this temperature is exceeded, the error message “Alarm temp. exceeded” appears on the display and a fault message is output at output AL.

```
TEMP. ALARM
Max. temp. 40°C
```

- Under BASIC PROGRAM ⇒ Temperature ⇒ Temp. alarm ⇒ Max. temp. enter and confirm the temperature at which the alarm is to be triggered if this temperature is exceeded.

```
TEMP. ALARM
Max. test time 10s
```

- Under Max. test time enter the duration of the temperature measurement (00 – 99 s). You can exclude short temperature fluctuations with a longer test time before an alarm is displayed
- Confirm with **OK**.

#### NOTE

If “0°C” has been entered here, the temperature is not monitored. An alarm will not sound even if the temperature of the medium increases rapidly.

## Temperature compensation

The temperature compensation ensures that the correct conductivity is measured even if the temperature of the medium changes.

In the TEMP . COMPENSATION menu define:

- whether temperature compensation is to occur automatically or manually,
- which temperature coefficient (factor) is to be used for temperature compensation,

### Entering the temperature coefficient (factor)

Enter the factor for the temperature coefficient of the medium to be measured. For natural water types, the temperature coefficient is about 2%/°C.

No input is necessary if you have selected Manual temp .

- Select and confirm

BASIC PROGRAM ⇒ Temperature  
⇒ Temp . compensation ⇒ Factor.

- Enter the factor.

|                     |      |
|---------------------|------|
| TEMP . COMPENSATION |      |
| Factor              | 2.00 |

### Calculate the temperature coefficient

Determine the temperature coefficient for media with unknown temperature coefficients (e. g. pure water) via a reference measurement as follows:

- Enter "1.0" as the factor under

BASIC PROGRAM ⇒ Temperature  
⇒ Temp . compensation ⇒ Factor.

- Measure the conductivity and the temperature of the medium at temperature T1.
- Measure the conductivity and the temperature of the same medium at temperature T2.

- Calculate the factor with the following formula:

$$\text{Factor} = \frac{\left( \frac{\text{Conductivity (T1)}}{\text{Conductivity (T2)}} \right)^{-1}}{T1 - T2}$$

- Enter the calculated factor under

BASIC PROGRAM ⇒ Temperature  
⇒ Temp . compensation ⇒ Factor

and confirm with **OK**.

```
TEMP. COMP.
Manual temp. 24°C
```

### Enter temperature manually

If you have not connected a temperature sensor to the connection PT100, enter the temperature of the medium manually here.

- Select and confirm  
BASIC PROGRAM ⇒ Temperature  
⇒ Temp. compensation ⇒ Manual temp.
- Enter the temperature and confirm with **OK**.

### Setting the pH temperature sensor

Select the temperature sensor which may be used for the pH probe to measure the temperature and for compensation. You can choose from

- manual setting
- the sensor in the inductive probe (data transfer with 20 mA current interface)
- the connected PT100/PT1000 board sensor according to the setting on the measurement card..

```
PH TEMP. SENSOR
Inductive *
```

- Select and confirm  
BASIC PROGRAM ⇒ Temperature  
⇒ pH temp. sensor
- Select the sensor used and confirm with **OK**.
- Select under `Sensor connection`, you are connecting a 2, 3 or 4 wire probe.
- Confirm with **OK**.

The temperature of the medium used as a basis for the calculation can also be entered manually.

- Select `Manual` in the menu option to enter the temperature of the medium manually.

### Calibrating the pH temperature sensor

This menu option is used to calibrate the PT100 or PT1000 sensors on the pH probe.

```
CALIBRATE PH TEMP.
Set temp 20.0°C
```

- Select and confirm  
BASIC PROGRAM ⇒ Temperature  
⇒ Calibrate pH temp.
- Enter the nominal temperature and confirm with **OK**.
- Start the calibration with `Calibration start`.
- If you wish to delete the calibration, select `Calibration re-set`.
- You can find a detailed description of the calibration in the chapter Service under [pH probe](#).

### Setting the CD temperature sensor

Select the temperature sensor which may be used for the conductivity probe to measure the temperature and for compensation.

You can choose from

```
CD TEMP. SENSOR
Inductive *
```

- manual setting
- the sensor in the inductive probe (data transfer with 20 mA current interface)
- the connected PT100/PT1000 board sensor according to the setting on the measurement card.

- Select and confirm  
BASIC PROGRAM ⇒ Temperature  
⇒ CD temp. sensor
- Select the sensor used and confirm with **OK**.
- Select under `Sensor connection`, you are connecting a 2, 3 or 4 wire probe.
- Confirm with **OK**.

The temperature of the medium used as a basis for the calculation can also be entered manually.

- Select `Manual` in the menu option to enter the temperature of the medium manually.

### Calibrating the CD temperature sensor

This menu option is used to calibrate the PT100 sensors on the LF probe.

```
CALIBRATE CD TEMP.
Set CD temp. 20.0°C
```

- Select and confirm  
BASIC PROGRAM ⇒ Temperature  
⇒ Calib. CD temp
- Enter the nominal temperature and confirm with **OK**.
- Start the calibration with `Calibration start`.
- If you wish to delete the calibration, select `Calibration reset`.
- You can find a detailed description of the calibration in the chapter Service under [Conductivity probe](#).

### Configuring the pH probe

```
pH
pH min.: 4.0
```

```
pH
Test time: 10s
```

- Enter under  
BASIC PROGRAM ⇒ pH ⇒ pH min. / pH max.  
the minimum and maximum value of the measuring range. An alarm is triggered if this range is exceeded or not attained.
- Enter under `Test time` the duration of the pH measurement (00 – 99s). You can exclude short fluctuations of the pH value with a longer test time before an alarm is displayed.
- Confirm with **OK**.

```
pH
Control *
```

- If no monitoring of the measuring range takes place, turn off the function under `Control`. A '-' means that there is no monitoring.

## Alter the language on the display

The MultiControl CT can display menu texts, error messages, etc. in seven languages.

```
LANGUAGE
English *
```

- Select and confirm  
`BASIC PROGRAM` ⇒ `Language`.  
 The `Language` menu appears. It includes the following languages:
  - German
  - English
  - French
  - Dutch
  - Polish
  - Spanish
  - Turkish
  - Further languages on request
- Select and confirm the desired language.  
 The activated language is indicated by a tick, the inactive languages by a minus sign. The menu texts, error messages, etc. then appear in the selected language.

## Serial interface

The serial RS232 interface transfers measurement data and alarms/notifications in plain text/ASCII in CSV format. It is always active.

## Notification format

The notifications are sent in a very similar format as the data placed on the SD card:

- The headings are not transmitted
- Field separator is a comma
- Decimal separator is a full stop
- Each data set is started with the ASCII characters "02" <STX> and terminated with "03" <ETX>.
- Notifications and measured values can be distinguished by evaluating the first characters: If "ME" is read, it is a measured value; with "AL", it is an alarm/notification.
- The sequence and meaning of the data is described below

Example of measured value:

```
<STX>ME,11.09.2017,14:43,0.0,pH,25.0,°C,100610.0,µS,25.0,°C,3300.000,µS,500.000,µS,<ETX>
```

Examples of notifications:

```
<STX>AL,05 SD card missing,11.09.2017,14:43<ETX>
<STX>AL,74 Sensor interrupted,12.09.2017,07:58<ETX>
```

For connection to a PC a so-called null modem cable is required.

### Baud rate

Transmission is in the 8 bit format, 1 stop bit, no parity.

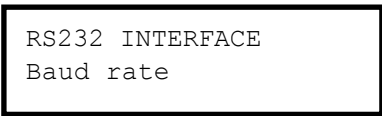

- Select and confirm  
BASIC PROGRAM ⇒ RS232 interface  
⇒ Baud rate  
and confirm with **OK**.
- Select the desired baud rate.  
The baud rate can be set to 2400, 9600 (default setting), 19200, 38400 and 115200.
- Confirm the selection with **OK**.

### SD card functions

The SD card can be used to record measurement values and errors as well as for importing and exporting the device settings.

Error and measurement value files are separately placed in subfolders arranged by year and month:

- In the year folder, files including measurement values and errors are arranged by month.  
The format of the file names is:  
ME<Year><Month>.csv for measurement values and  
AL<Year><Month>.csv for errors/alarms.
- In the year folders, as required, subfolders are placed for the 12 months of the year, within each of which a file for measurement values and errors per day is placed.  
The format of the filenames is ME<Year><Month><Day>.csv for measurement values and AL<Year><Month><Day>.csv for errors/alarms.
- Data is stored in the "Comma-Separated-Value" format, to facilitate inclusion in spreadsheet programs and to allow it to be easily imported into databases.



**NOTE****Link between time and correct data**

To ensure that the naming of the file and the time and date details in the file are correct, the time function must work properly. If the [battery](#) drains, the date is automatically set to 1.1.2011, 12:00 and the data is stored. Data is not lost, since new measurement values and errors are appended to existing files. However, only one file is described in each case, since the month and day are not subject to change.

**Displaying free storage space**

```
SD CARD
Free 2040 MByte
```

- Select in the menu  
BASIC PROGRAM ⇒ SD Card  
and confirm with **OK**.

The free storage space is displayed in Mbyte. With memory cards larger than 4 GB, the display may become faulty!

**Storing measurement values**

```
SD CARD
Save meas. data ✓
```

The storing of measurement values on the SD card is activated when in the menu

BASIC PROGRAM ⇒ SD Card ⇒ Save meas. data

is activated. A check mark indicates that the function is active. A minus indicates that the function is turned off.

Example for a CSV file imported into Excel:

|   | A    | B          | C     | D        | E       | F         | G        | H        | I       | J         | K        | L            | M           | N            | O           |
|---|------|------------|-------|----------|---------|-----------|----------|----------|---------|-----------|----------|--------------|-------------|--------------|-------------|
| 1 | type | date       | time  | pH.value | pH.unit | TpH.value | TpH.unit | CD.value | CD.unit | Tcd.value | Tcd.unit | limit1.value | limit1.unit | limit2.value | limit2.unit |
| 2 | ME   | 11.09.2017 | 14:43 | 0.0      | pH      | 25.0      | °C       | 100610.0 | µS      | 25.0      | °C       | 3.300.000    | µS          | 500.000      | µS          |
| 3 | ME   | 11.09.2017 | 14:44 | 0.0      | pH      | 0.0       | °C       | 0.0      | µS      | 0.0       | °C       | 3.300.000    | µS          | 500.000      | µS          |

**Storage interval**

In this menu you can set how frequently measurement values are stored (001 ... 999 min.).

```
SD CARD
Storage interval 60min
```

- Select in the menu  
BASIC PROGRAM ⇒ SD Card  
⇒ Storage interval
- Enter the storage interval and confirm with **OK**.

**Save alarms**

```
SD CARD
Save alarms ✓
```

The storing of the alarms/error messages on the SD card is activated, when in the menu

BASIC PROGRAM ⇒ SD Card ⇒ Save alarms

is activated. A check mark indicates that the function is active. A minus indicates that the function is turned off.

Example for a CSV file imported into Excel:

|   | A    | B                   | C          | D     |
|---|------|---------------------|------------|-------|
| 1 | type | error message       | date       | time  |
| 2 | AL   | 05 SD Karte fehlt   | 11.09.2017 | 14:43 |
| 3 | AL   | 01 Spannungsausfall | 11.09.2017 | 14:44 |

### Interim storage for a non-inserted SD card

Even if no SD card is currently inserted, no measurement values and errors are lost, since the most recently error and measurement values, which have not yet been written into storage, are saved on internal interim storage (ring memory).

As soon as an SD card is inserted, the interim stored data is transmitted.

The capacity of this interim buffer is 50 error and 100 measurement values. After this point, the oldest values will be overwritten.

### Capacity of the SD card

The storage requirement for 10,000 measurement values amounts to around 1MByte. If error messages occur for one percent of the measurement values, a 2GB SD card for example may have around 19 million measurement values and errors.

### Saving changes

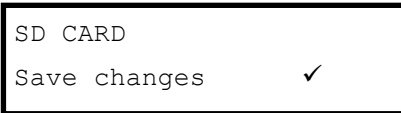

This function logs the status changes at inputs and outputs with time stamps. A file 'change.csv' is created or added to the SD card when you select in the menu

BASIC PROGRAM ⇒ SD Card ⇒ Save changes

activate. A check mark indicates that the function is active. A minus indicates that the function is turned off. This setting is not saved, and the data are not transmitted via the serial interface!

An example for a CSV file imported into Excel:

|    | A          | B        | C   | D   | E   | F   | G   | H   | I  | J   | K   | L  | M  | N     | O     | P     | Q     | R     | S     | T     | U     |    |
|----|------------|----------|-----|-----|-----|-----|-----|-----|----|-----|-----|----|----|-------|-------|-------|-------|-------|-------|-------|-------|----|
| 1  | Date       | Time     | IN1 | IN2 | IN3 | IN4 | IN5 | IN6 | K1 | K2  | K3  | K4 | K5 | pH    | pH    | T(pH) | T(pH) | CD    | CD    | T(CD) | T(CD) |    |
| 2  | dd.mm.yyyy | hh:mm:ss | WM  | NB1 | NB2 | NIN | PAD | STP | PR | PU1 | PU2 | BV | AL | value | unit  | value | unit  | value | unit  | value | unit  |    |
| 3  | 16.09.2016 | 08:30:41 | 0   | 0   | 0   | 0   | 0   | 0   | 0  | 0   | 0   | 0  | 0  | 1     | 1.000 | pH    | 0.000 | °C    | 7.300 | µS    | 0.000 | °C |
| 4  | 16.09.2016 | 08:31:58 | 0   | 1   | 0   | 0   | 0   | 0   | 0  | 0   | 0   | 0  | 0  | 1     | 1.000 | pH    | 0.000 | °C    | 7.300 | µS    | 0.000 | °C |
| 5  | 16.09.2016 | 08:31:59 | 0   | 0   | 0   | 0   | 0   | 0   | 0  | 0   | 0   | 0  | 0  | 1     | 1.000 | pH    | 0.000 | °C    | 7.300 | µS    | 0.000 | °C |
| 6  | 16.09.2016 | 08:31:59 | 0   | 0   | 1   | 0   | 0   | 0   | 0  | 0   | 0   | 0  | 0  | 1     | 1.000 | pH    | 0.000 | °C    | 7.300 | µS    | 0.000 | °C |
| 7  | 16.09.2016 | 08:32:00 | 0   | 0   | 0   | 0   | 0   | 0   | 0  | 0   | 0   | 0  | 0  | 1     | 1.000 | pH    | 0.000 | °C    | 7.300 | µS    | 0.000 | °C |
| 8  | 16.09.2016 | 08:32:00 | 0   | 0   | 0   | 1   | 0   | 0   | 0  | 0   | 0   | 0  | 0  | 1     | 1.000 | pH    | 0.000 | °C    | 7.300 | µS    | 0.000 | °C |
| 9  | 16.09.2016 | 08:32:00 | 0   | 0   | 0   | 0   | 0   | 0   | 0  | 0   | 0   | 0  | 0  | 1     | 1.000 | pH    | 0.000 | °C    | 7.300 | µS    | 0.000 | °C |
| 10 | 16.09.2016 | 08:32:01 | 0   | 0   | 0   | 0   | 1   | 0   | 0  | 0   | 0   | 0  | 0  | 1     | 1.000 | pH    | 0.000 | °C    | 7.300 | µS    | 0.000 | °C |
| 11 | 16.09.2016 | 08:32:01 | 0   | 0   | 0   | 0   | 0   | 0   | 0  | 0   | 0   | 0  | 0  | 1     | 1.000 | pH    | 0.000 | °C    | 7.300 | µS    | 0.000 | °C |

First, the time stamp is stored. Then the states of the inputs follow (1 = active corresponding to the logic input level, that is, after possible inversion!) IN1..6 and the relay K1..K5 (1=active). The alarm relay is always active if no alarm is present, as it should also report a power failure. After this, the measurement values follow

A change in the water meter intake WM1 does not lead to log entries since its function can be easily controlled at the inlet LED and too many entries would be generated.

## NOTE

### For importing CSV files into OpenOffice or LibreOffice Calc:

For special characters to be displayed correctly, import the CSV file with the character set 'Western Europe (ISO9959-1)'. Separation options are with commas and semicolons as well as 'values in inverted commas as text'.

Within the file, the comma is included as a separator in the first line 'sep=,', so that it can be imported directly into Microsoft Excel. If OpenOffice or LibreOffice Calc are used, this line appears after the import. It may be deleted.

```
SD CARD
Import basic data
```

### Import basic programming data

➤ Select in the menu

```
BASIC PROGRAM ⇒ SD Card ⇒ Import basic
data
```

one of the files in the root directory of the SD card with the ending ".ini" using the arrow keys.

➤ Import the files with "OK".

If an error message occurs during the import, the format of the data is defective. This may occur if the file has been edited. In this case no settings are changed. Use a simple text editor for editing (e.g. Word-Pad), not a word processor, since otherwise the formatting may be changed!

All device settings are imported except

- Language settings
- Operating hours counter
- Password
- Password protection

### Export basic programming data

In the menu

```
SD CARD
Export basic data
```

```
BASIC PROGRAM ⇒ SD Card ⇒ Export basic data
```

all settings of the MultiControl device can be stored in a file on the SD card.

This function is recommended for:

- Storing multiple configuration profiles for one device
- Transferring settings onto other devices
- Configuring multiple devices with identical settings
- Remote maintenance / support via transfer of the basic programming data

The filename is preset to "bdata00.ini" (for "Basic Data" / basic programming data). The digits are adjustable, meaning that in total 100

different files from "bdata00.ini" up to "bdata99.ini" can be selected. The files are always stored in the root directory of the SD card.

---

**NOTE**

**Editing the file**

The settings are in the file in text form and can be displayed or edited, with for example the notepad application on a PC. Use a simple text editor, not a word processor, since otherwise the formatting may be changed!

If files (for example when creating profiles) are later renamed on the PC, please note that the indicator of the MultiControl device is limited to 24 characters. Longer filenames cannot be distinguished on the MultiControl CT!

---

## Settings for the ADI card

### Configuring the current interface

If an ADI card (analogue digital interface) is installed, two current interfaces are available as outputs. The 0/4 to 20 mA current interface is suitable, for example, for connecting a recorder or for forwarding the measurement values to a controller (PLC) or master display. Configure the span/spread and the lower and upper limits to adjust the output signal to your needs.

➤ Select and confirm

BASIC PROGRAM ⇒ ADI card ⇒ Interface Type

0-20 mA:

If this menu option is activated, the interface outputs currents from 0 to 20 mA.

4-20 mA:

If this menu option is activated, the interface outputs currents from 4 to 20 mA.

```
INTERFACE TYPE
0-20 mA *
```

```
INTERFACE TYPE
4-20 mA *
```

**The maximum load of 500 Ω must not be exceeded!**

### Specify scaling

If temperature values are to be output, the scaling of the temperature range must be specified.

➤ Enter the temperature range under

BASIC PROGRAM ⇒ ADI Card ⇒ Interface Type  
⇒ Min. temp. / Max. temp.

For the pH value output, the scaling is set from pH 1 – 14.

For the conductivity output, the scaling is determined by the measuring range of the probe used and the cell constant.

```
INTERFACE TYPE
Min. temp. 5.0°C
```

```
INTERFACE TYPE
Max. temp. 45.0°C
```

### Selection of displayed signals

For the output, select two signals to be displayed. The same setting can also be selected for both signals.

➤ Choose from

BASIC PROGRAM ⇒ ADI Card ⇒

Output interface 1/2

the signal to be displayed.

```
OUTPUT INTERFACE 1
CD *
```

```
OUTPUT INTERFACE 2
Temperature *
```

```
ADI CARD
RS232 Baudrate
```

### Baud rate

Transmission is in the 8 bit format, 1 stop bit, no parity.

- Select and confirm  
BASIC PROGRAM ⇒ ADI card ⇒ RS232 Baudrate and confirm with **OK**.
- Select the desired baud rate.  
The baud rate can be set to 2400, 9600 (default setting), 19200, 38400 and 115200.
- Confirm the selection with **OK**.

### LCD settings

The MultiControl CT comes with a large-scale backlit graphic-enhanced LC display. You can adjust brightness and contrast.

```
Brightness 8
Contrast 4
```

- Select and confirm  
BASIC PROGRAM ⇒ LCD settings.  
When you change a setting, brightness or contrast are adapted on the display for previewing purposes. The settings are thus not yet stored.
- Press "**OK**", to confirm the settings.

---

### Backlighting

Please note that the background lighting is completely switched off for brightness 1. The readability is then only ensured in very bright light (direct sunlight).

There are extensive contrast adjustment options. Values between "3" and "7" are advisable here.

In the event of very warm or cold ambient temperatures, the display may no longer be optimally readable. Correct this by adjusting the brightness and contrast until the display is again readable.

---

**NOTE**

## Alarm/message – How to proceed when errors occur

Error messages are adapted to the selected language, but can also be identified by an error number, regardless of the language used.

Just how the error is displayed can be configured in the menu

```
ALARM/MESSAGE
Biocide1 low A
Biocide2 low A
Inhibitor low A
...
pH limit exceeded A
```

BASIC PROGRAM ⇒ Alarm/message

- – : are not provided at all.  
This selection is not always available!
- M: the error is displayed as a message.
- A: the error is displayed as a message and the alarm relay is also switched.

All errors are, regardless of the settings made in this menu option:

- stored on SD card if [Storing of error messages](#) has been activated
- recorded in the error history (the last 20 error messages)
- and sent via the serial RS232 interface.

Detailed information on possible error messages as well as their cause and remedy is found in [Error messages / troubleshooting](#)

### NOTE

#### Error messages after self-test

For error messages caused by an improperly executed self-test, no settings can be made; see [Error messages after self-test](#).

#### Standby mode

Here you can define how to proceed with the started metering/desalination after a standby signal (IN6 active).

```
STANDBY MODE
Cancel *
```

```
STANDBY MODE
Cut off *
```

##### ➤ Select and confirm

BASIC PROGRAM ⇒ Standby mode

##### ➤ Select `cancel` or `cut off` and confirm the selection with **OK**.

With `cancel` the metering/desalination is stopped and defined as ended.

With `Cut off` the metering/desalination is stopped and executed again later.

## Configuring the idle state of the inputs

```
IDLE STATE IN 2
Normally open *
```

The idle state can be configured for the signal inputs IN2..IN6. For each input, a corresponding menu option with the options Normally closed or Normally open is available for:

- IN2 (level switch biocide 1):

BASIC PROGRAM ⇒ Idle state IN 2

- IN3 (level switch biocide 2)

BASIC PROGRAM ⇒ Idle state IN 3

- IN4 (level switch inhibitor)

BASIC PROGRAM ⇒ Idle state IN 4

- IN5 (flow monitor)

BASIC PROGRAM ⇒ Idle state IN 5

- IN6 (stop input)

BASIC PROGRAM ⇒ Idle state IN 6

The setting is not necessary for the water meter intake IN1, since only metering pulses are detected here.

## Password

### Enter password

The password is a 4-digit password between 0000 and 9999. It is factory set to 0000.

```
ENTER PASSWORD
Password 0000
```

- Select and confirm BASIC PROGRAM ⇒ Enter password. Password 0000” appears on the display.
- Enter the password and confirm it via the **OK** key.
- Once the correct password has been entered, the Basic program menu opens. BASIC PROGRAM appears on the display.

### Change password

The setting is not necessary for the water meter intake IN1, since only metering pulses are detected here 0000.

```
CHANGE PASSWORD
New: 0000
```

- Select and confirm to change the password BASIC PROGRAM ⇒ Change password.
- Enter the current password.
- Enter the four digits for the new password one after the other.
- Confirm the input with **OK**. The password is changed. Remember or make a note of the new password.



## Password protection

You can protect access to the basic program with a password. Activate the password protection for this purpose.

```
PASSWORD PROTECTION
Active: ✓
```

- Select and confirm  
BASIC PROGRAM ⇒ Password protection.
- Enter the current password.
- Select `Active` and confirm with **OK**.  
A check mark indicates that the password protection is activated.  
A minus indicates that the password protection is not active.

## Firmware Update

### Menu-driven firmware update

In the menu

```
BASIC PROGRAM ⇒ Firmware update
```

the operating software of the device is updated. For this purpose, you need an SD card.

```
FIRMWARE UPDATE
Start
```

Implement the firmware update as follows:

- Download the firmware update for the MultiControl CT from the Heyl website ([www.hey1.de](http://www.hey1.de)) and save it in the root directory of the SD card.
- Insert the SD card into the device.
- Select in the menu  
BASIC PROGRAM => Firmware update
- `Start` is displayed. Confirm the selection with **OK**
- Select the filename of the update.
- Confirm the selection with **OK**.
- Confirm the security prompt with **OK** (or cancel with **M**).

```
START
152M001S00.upd
```

```
START
Are you sure? (OK/M)
```

The device restarts and implements the update.



The programming progress is indicated as bars with five LEDs on the front panel and with text on the display:

Initially, only the left LED EC1 flashes slowly (once every two seconds) and later permanently, whereupon the next LED begins flashing. The process is repeated until all LEDs light up permanently.

The firmware update is now complete. The MultiControl CT is started automatically with the new operating software. The complete firmware update takes around 70 seconds.

### Possible errors:

- If an error message is displayed at the beginning, there is a problem with the SD card or the file for the update itself.  
Check,  
- whether the SD card is write-protected or

- if a file has been used for another device or
  - if the file is corrupted (the checksums are not correct).
- The update does not start; The existing firmware is not changed.

- If the LEDs on the front flash very quickly (10x per second) after start-up, then an error has occurred during the update. The error is displayed as text at the same time.
- See [Firmware update error messages](#).

**NOTE**

---

**Obtain the settings after the firmware update**

After a firmware update, the device may be in an undefined state. After a firmware update, basic programming should therefore always be performed. If the settings have been preserved, it is advisable to export the settings onto the SD card before the firmware update and after the firmware update, to import the saved settings

**Passwords**

The set password is preserved even after the firmware update.

**Error and update log**

During the update a file called "update.txt" is written onto the SD card, which includes a record of the update progress and any errors having occurred in the process.

Open these files with your editor of choice (e.g. Notepad), to read the relevant content.

The file is not deleted, but supplemented. If the same SD card is always used for a device, it will provide an overview of all the firmware updates performed for the device in question.

---



Observe ESD safety precautions! See the information on page 8

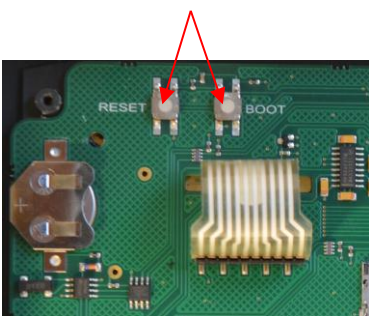

---

**Manual firmware update**

The manual firmware update facilitates the recovery of software after failed firmware updates. The device buttons are not used in the process.

- Press and hold the RESET button and the BOOT button on the [control board](#). Release the RESET button and press down the BOOT button for 5 additional seconds. The update process progresses in the manner described for a menu-driven update.
- For information on handling errors see [Firmware update error messages](#).

## Service menu

### Service info

```
SERVICE INFO
Calibrating
```

The calibration data are displayed here

- The date of the last calibration is displayed with  
SERVICE ⇒ Service info ⇒ Calibrating ⇒ on
- The zero value is displayed with  
SERVICE ⇒ Service info ⇒ Calibrating  
⇒ CD zero
- The calibrating factor is displayed with  
SERVICE ⇒ Service info ⇒ Calibrating  
⇒ CD Factor

### Service interval

```
SERVICE INTERVAL
Interval 200d
```

In the menu SERVICE ⇒ Service interval you can change the settings for the maintenance interval:

- Under Interval you can enter the maintenance interval in days (often used for the conductivity probe).
- Switch on the Alarm, if an alarm is to be issued for maintenance. A check mark indicates that the function is active. A minus indicates that the function is turned off.
- Press Quit to reset the interval to the value set above.
- Once the maintenance interval has elapsed, the message Service exceeded appears in the display.

#### NOTE

---

If you set the maintenance interval to 0, no monitoring is performed.

---

- To configure the type of message, select  
BASIC PROGRAM ⇒ Alarm/messages ⇒ Service exceeded ⇒ A or M.
  - If A is configured, the alarm signal is issued as soon as the maintenance interval has elapsed.
  - If M is configured, a message is issued as soon as the maintenance interval has elapsed.
  - If there is a minus sign after alarm, no signal is issued at all.
- Press  $\Delta \nabla$  to change the alarm's status.
- Confirm with **OK**.

## Displaying or resetting the operating hours

The MultiControl CT records the operating hours. To display these, select:

```
OPERATING TIME
Time: 10256h
```

SERVICE ⇒ Operating time

The status of the operating hour counter is displayed.

To reset the operating hours to zero hours (reset):

- Select and confirm Time reset (OK)
- The **OK** button is used to reset the number of hours to zero.

## Time and Date

```
SERVICE
Time date
```

- Select and confirm to change the data and time  
SERVICE ⇒ Time date
- Move the cursor with the buttons <|> to the desired position in the time/date field
- Select the desired figure by pressing the cursor keys ▽△.
- Confirm the newly set values for the time and date with **OK**.
- Select Set the automatic summertime/wintertime changeover under Automatic.  
A check mark indicates that the function is active. A minus indicates that the function is turned off.
- Confirm the setting with **OK**.

### NOTE

The clock continues to run even if the device is switched off.

```
TIME FORMAT
dd.mm.yy *
```

## Configuring the time format

- Select and confirm to adapt the representation of the date  
SERVICE ⇒ Time format
- Select one of the following formats:  
dd.mm.yy  
yy/mm/dd
- Confirm the setting with **OK**.

## Displaying or deleting the error history

The error history is a list of the error messages or states that have occurred during ongoing operation. The error history is also stored in the event of a voltage failure. Errors that arise are registered with time and date – if the battery of the clock is not empty. The number of error messages can be exported or read out, but not the error history itself.

To display the error history:

- Select and confirm  
SERVICE ⇒ Error history ⇒ Show.  
The last error message is displayed.
- Press the ▾ arrow button to display older error messages.

You can delete the error messages saved in the error history and restart the data logging.

To delete the error history:

- Select and confirm  
SERVICE ⇒ Error history ⇒ Delete.

ERROR HISTORY  
Show

### NOTE

---

All saved error messages are deleted.

---

## Diagnosis

You can manipulate the switching states of the relays for test purposes, for example during commissioning, or display the states of the inputs.

### Inputs

To display the switching states:

- Select and confirm  
SERVICE ⇒ Diagnosis ⇒ Inputs  
⇒ Diag IN1  
...  
⇒ Diag IN6

A check mark corresponds to an active input, a minus indicates that the input is switched off. The setting for [Configuring the idle state of the inputs](#) does not influence here.

- Under IN mA you can display which conductivity and temperature arrive at the input.

DIAGNOSIS  
Inputs

DIAGNOSIS  
Outputs

## Outputs

To display the switching states:

- Select and confirm  
SERVICE ⇒ Diagnosis ⇒ Outputs ⇒ K1 .. K5
- You can switch the relay with **OK**. A check mark corresponds to an active relay (C-NO is then closed, C-NC is open). A minus indicates that the output is switched off..
- Under OUT mA you can select whether a current of 4 mA or 20 mA is issued.



---

### Risk of injury and/or danger of damage to equipment parts!

If you manipulate the relays that connect the connections for consumers, you will trigger the corresponding responses from the connected system. This can injure people or damage the equipment parts.

- Ensure that people are not endangered and downstream equipment parts are not damaged before manipulating the relays.
- 

## Calibrating the probes

### pH probe

Before using the device, you must calibrate the pH probe.

The pH probe is calibrated with the aid of two buffer solutions (two-point calibration). The pH value of each solution should be as far apart as possible. Since the values of the buffer solutions are temperature-dependent, the type of temperature compensation must first be selected.

BASIC PROGRAM  
Temperature

#### If the pH probe contains a PT100 temperature sensor:

- Select  
BASIC PROGRAM ⇒ Temperature ⇒ pH Temp. sensor ⇒ Pt100x pH

#### If the pH probe contains a PT1000 temperature sensor:

- Select  
BASIC PROGRAM ⇒ Temperature ⇒ pH temp. sensor ⇒ Pt100x pH

#### If the probe does not have a temperature sensor:

- Select  
BASIC PROGRAM ⇒ Temperature ⇒ pH temp. sensor ⇒ Manual  
and  
BASIC PROGRAM ⇒ Temperature ⇒ Temp. compensation ⇒ Manual temp.  
Enter the temperature of the buffer solution.

```
SERVICE
Calibrating pH
```

Proceed as follows for the calibration:

- The pH values of the two buffer solutions are set in  
SERVICE ⇒ Calibrating pH  
⇒ Buffer solution 1 pH and  
⇒ Buffer solution 2 pH.
- The calibration is started with Start (OK) .
- The result is shown under Slope.

```
CALIBRATING pH
Reset (OK)
```

#### Reset calibration to standard values

To cancel incorrect calibration, either repeat the calibration process, as described in the previous section, or reset calibration as follows:

- Select and confirm  
SERVICE ⇒ Calibrating pH ⇒ Reset (OK).  
Calibration is reset to the standard value. Your measuring system is not calibrated! The calibration reset is registered with the time and date.

#### Conductivity probe

If the EC/pH card is installed, a conductive conductivity probe can be connected to the MultiControl CT. Calibrate the probe including the temperature probe as follows.

The most precise measurements are achieved via two-point calibration. To achieve this, calibrate

- the zero point
  - and the target value
- of the conductivity probe.

#### Zero point calibration

Measuring error (offset) caused, e.g., by a temperature drift in the measuring system can be counterbalanced via zero point calibration. If zero point calibration is not carried out, the measuring results will be less exact.

- Ensure that the probe with the final cable length has been connected, but is completely dry and not wetted with the measuring medium.
- Select the menu items  
SERVICE ⇒ Calibrating CD  
⇒ Calibration CD zero.
- Press **OK** to start zero point calibration.

```
CALIBRATING CD
Calibration CD zero
```

Zero point calibration finishes automatically. MultiControl CT corrects the measuring error by forming the difference.

- Subsequently execute target value calibration.

### Target value calibration

Measuring errors which are caused by a soiled probe can be corrected via target value calibration. Target value calibration is particularly suitable if there are high accuracy requirements in a limited measuring range. Furthermore, this method allows you to carry out measurements whose cell constant is unknown with a probe.

Depending on the application, the target value can be calibrated in three different ways:

- Calibration without temperature compensation
- Calibration with temperature compensation for constant medium temperature
- Calibration with temperature compensation for variable medium temperature.

#### Calibration without temperature compensation

Carry out calibration without temperature compensation when the temperature of the medium is approx. 15 C and remains constant.

To achieve this, the correction factor determined from a comparison measurement and the display has to be entered manually.

Formula to calculate the correction factor:

$$\text{Correction factor} = \frac{\text{reference measured value}}{\text{displayed measured value}}$$

- Enter the correction factor evaluated as described above under SERVICE ⇒ Calibrating CD ⇒ Factor.  
The entered correction factor is immediately operative.

```
CALIBRATING CD
Factor 1.00
```

#### Calibration with temperature compensation for constant medium temperature

If a **probe without temperature sensor** is used, the temperature of the medium has to be entered. Proceed as follows:

- Select and confirm the “manual” option in the menu  
BASIC PROGRAM ⇒ Temperature  
⇒ CD temp. sensor
- Enter the temperature of the calibration solvent under  
BASIC PROGRAM ⇒ Temperature ⇒ Temp. compensation ⇒ Manual temp.

```
CD TEMP. SENSOR
Manual ✓
```

```
TEMP. COMPENSATION
Manual temp. 20°C
```

If a **probe with temperature sensor** is used, enter a fixed factor as the temperature coefficient. Proceed as follows:

- Enter 1.90%/°C as the temperature coefficient under  
BASIC PROGRAM ⇒ Temperature  
⇒ Temp. compensation ⇒ Factor.

```
TEMP. COMPENSATION
Factor 1.90
```

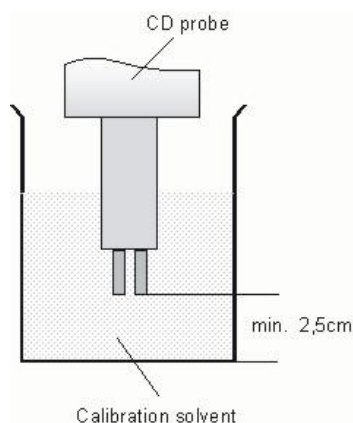

```
CALIBRATING CD
Setpoint 1234.56 $\frac{\mu\text{S}}{\text{cm}}$
```

**CAUTION**

```
CALIBRATING CD
Reset (OK)
```

```
DEFAULT SETTINGS
Execute
```

**Start target value calibration**

- Enter the conductivity of the calibration solvent at 25 °C under SERVICE ⇒ Calibrating CD ⇒ Setpoint.  
If the conductivity of the calibration solvent deviates by more than  $\pm 50\%$  from this target value during target value calibration, the calibration process is terminated and "Error" appears on the LC display.

**Risk of incorrect measured values!**

If calibration is not carried out or an unsuitable calibration solvent is used, it will result in incorrect measured values.

- Always calibrate with a calibration solvent in accordance with DIN EN 27888

- Dip the measuring probe into the calibration solvent as shown left.
- After inserting a probe with temperature sensor, wait approx. 2 minutes before starting calibration, thus ensuring that the probe has the same temperature as the solvent.
- Select and confirm SERVICE ⇒ Calibrating CD ⇒ Start (OK).
- Press **OK** to start target value calibration.

Calibration finishes automatically. MultiControl CT corrects the measuring error by forming a correction factor.

The calibration is registered with the time and date.

**Reset calibration to standard values**

To cancel incorrect calibration, either repeat the calibration process, as described in the previous section, or reset calibration as follows:

- Select and confirm SERVICE ⇒ Calibrating CD ⇒ Reset (OK).  
Calibration is reset to the standard value. Your measuring system is not calibrated! The calibration reset is registered with the time and date.

**Inductive conductivity probe**

The MultiControl CT does not contain any settings for calibration since the transmitted values are simply adopted from the current interface of the EC inductive/pH card. On the contrary, the current interface's scaling ([Measuring range CD](#) and [temperature measuring range](#)) must be configured correctly. Follow the manufacturer's instructions provided in the guide for the probe.

**Factory settings**

- In the menu SERVICE ⇒ Default settings the device can be reset to the factory settings.

## Servicing and maintenance

The MultiControl CT itself is virtually maintenance-free. However, we recommend that you back up the data of a SD card used once a month.

### Replacing the backup battery



Observe ESD safety precautions! See the information on page 8

When the device is switched off the internal clock is powered by a lithium backup battery (CR2032 type), which is designed to have a service life of 10 years. After this period, it should be replaced for preventive reasons, and always ensuring a measured voltage  $<2.3V$ .

The following is required when replacing the battery

- A Phillips-tip screwdriver (insulated)
- A replacement battery CR 2032

Replace the battery as follows:

- Disconnect the device from the power supply
- Open the cover
- Using a non-conductive tool, carefully prise the used battery out of its mounting on the [control board](#). Avoid damaging the circuit board with the sharp edge of a screwdriver.
- Insert the replacement battery
- Close the cover again
- Reconnect the power supply once again
- The date and time must now be [reset](#).

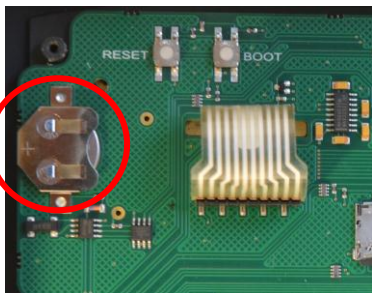

### Reset service interval

See chapter [Service interval](#).

### Reset operating time counter

See chapter [Displaying or resetting the operating hours](#).

## Replacing fuses

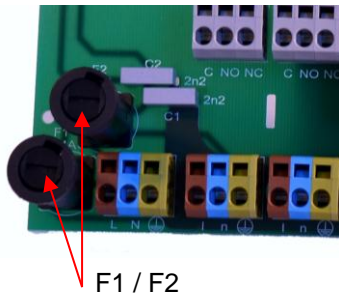

F1 / F2

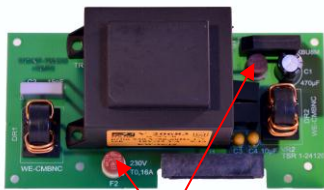

F2 / F3

The main fuses F1 and F2 (T4A) are on the motherboard as a glass fuse in the holder ([connections on the motherboard](#)). If the voltage supply of 230V is applied to the device and no voltage can be measured at the terminals, then one of these fuses is defective.

The pluggable 230V power supply board with transformer contains the primary fuse F2 (T160 mA) and the secondary fuse F3 (T1.6A). Both are pluggable ([fuses on the power supply pack plug-in card](#)).

If the result of the preceding test that 230V is applied, and the 3.3V/12V LEDs do not light up, then one of these fuses is defective. Use a multimeter to determine the state of the fuses by means of a continuity test.

## Troubleshooting

The MultiControl CT comes with extensive capabilities for the detection of errors. If the device does not appear to be behaving properly, please remember that the device is part of a system with many sensors. If these sensors are not working correctly, incorrect inputs are generated, which can lead to the malfunction of the device.

Therefore please check in such cases:

- Device settings: You can view the device settings in the [Information menu](#) or, where applicable, [export the SD card](#) and verify easier with a text editor.
- Input signals of the sensors and level switches: [Service menu diagnosis](#).
- Output relay: To check whether the connected pumps or horns are working, the [Diagnostic menu](#) is also used. The outputs can be switched for test reasons.
- The [change log](#) is an additional aid. In order to understand the controller's handling, the changes to all inputs and outputs are logged in a file with a time stamp.

Should problems or questions arise while operating MultiControl CT which are not described in these operating instructions and/or cannot be solved, please contact our technical hotline.

Try to identify the problem as accurately as possible and record the actions and conditions under which it occurred. This will enable us to offer you swift effective assistance.

In order to help you with system problems, we require:

- The device settings
- The system's wiring diagram
- The system's flow chart

The more accurately you can describe the incident, the faster and more effectively we can help you.

Tel.: +49 (0)5121 7609-51

Fax: +49 (0)5121 7609-44

E-Mail: [info@heyl.de](mailto:info@heyl.de)

## Error messages/troubleshooting

Errors will be recorded in the error history as far as capacity allows (after which the oldest message will be deleted).

In addition, [error messages can be stored on the SD card](#), if in the menu

BASIC PROGRAM => SD Card => Save alarms has been activated.

Details of errors are always sent via the serial RS32 interface.

Errors are handled differently depending on type:

All errors, for which user access is required to recover the function of the device, are shown as alerts. In addition, an alarm may be triggered. However, it is not possible to completely disable the message, since the selection "-" is locked in the menu.

In the event of any recurrence, the configured action (message or alarm) is again triggered. The time of occurrence is recorded in the alarm log. These errors include:

| Error number/error message | Description, possible causes                                                                                                                            | Solution, troubleshooting measures                                                                                                                                  |
|----------------------------|---------------------------------------------------------------------------------------------------------------------------------------------------------|---------------------------------------------------------------------------------------------------------------------------------------------------------------------|
| 01 Power failure           | <ul style="list-style-type: none"> <li>➤ Prior power failure (also when switching off)</li> </ul>                                                       | <ul style="list-style-type: none"> <li>➤ Check power supply</li> </ul>                                                                                              |
| 20 Power failure 12V       | <ul style="list-style-type: none"> <li>➤ Failure of the internal 12V power supply</li> </ul>                                                            | <ul style="list-style-type: none"> <li>➤ Replace 12V fuse</li> <li>➤ For all other defects, the device must be repaired</li> </ul>                                  |
| 03 RTC bus error           | <ul style="list-style-type: none"> <li>➤ Connection to clock broken</li> </ul>                                                                          | <ul style="list-style-type: none"> <li>➤ Device should be repaired, so that the clock works. If the time is not relevant, you can keep using the device.</li> </ul> |
| 06 SD Card w. protected    | <ul style="list-style-type: none"> <li>➤ Card is write-protected</li> </ul>                                                                             | <ul style="list-style-type: none"> <li>➤ The write-protect tab at the side of the SD card must not be set to "LOCK"</li> </ul>                                      |
| 07 SD Card unformatted     | <ul style="list-style-type: none"> <li>➤ Card not formatted or formatted with an invalid file system</li> </ul>                                         | <ul style="list-style-type: none"> <li>➤ Format the SD card with a FAT or FAT32 file system</li> </ul>                                                              |
| 08 SD Card full            | <ul style="list-style-type: none"> <li>➤ Error when accessing SD card, because the file is write-protected or the card is full or defective.</li> </ul> | <ul style="list-style-type: none"> <li>➤ Remove the write protection of the file</li> <li>➤ Wipe the card</li> <li>➤ Insert new card</li> </ul>                     |
| 13 Service exceeded        | <ul style="list-style-type: none"> <li>➤ The maintenance interval was exceeded</li> </ul>                                                               | <ul style="list-style-type: none"> <li>➤ Perform maintenance</li> </ul>                                                                                             |

| Error number/error message | Description, possible causes                              | Solution, troubleshooting measures                                 |
|----------------------------|-----------------------------------------------------------|--------------------------------------------------------------------|
| 67 Max. bleed duration     | ➤ The permissible desalination period has been exceeded   | ➤ Check desalting valve and increase the duration where applicable |
| 71 Biocide1 low            | ➤ Supply of biocide 1 exhausted                           | ➤ Refill                                                           |
| 72 Biocide2 low            | ➤ Supply of biocide 2 exhausted                           | ➤ Refill                                                           |
| 73 Inhibitor shortage      | ➤ Supply of inhibitor exhausted                           | ➤ Refill                                                           |
| 74 Sensor separate         | ➤ Invalid sensor measurement values                       | ➤ Check connection and data in the diagnosis menu                  |
| 75 PH limit below          | ➤ Limit value for pH is not attained                      | ➤ Risk of corrosion, stabilise pH                                  |
| 76 PH limit exceeded       | ➤ Limit value for pH has been exceeded                    | ➤ Risk of corrosion, stabilise pH                                  |
| 09 Alarm temp. below       | ➤ Limit value for the alarm temperature is not attained   | ➤ Warm the cooling water                                           |
| 10 Alarm temp. exceeded    | ➤ Limit value for the alarm temperature has been exceeded | ➤ Cool the cooling water                                           |

All errors that occur only intermittently, which means they impact only on the analysis process, are cyclically checked by the device and automatically deleted when no longer present.

If these error messages are acknowledged, only the alarm is deactivated. The error message is not, however, deleted. It is deleted only when the error no longer occurs after rechecking.

These errors can also be ignored when in the [Alarm/message](#) is selected.

Likewise, two notification messages are written via the serial interface and onto the SD card with the start and end times of the error (see [Message format](#)).

These errors include:

| Error number/error message | Description, possible causes                                                                       | Solution, troubleshooting measures                              |
|----------------------------|----------------------------------------------------------------------------------------------------|-----------------------------------------------------------------|
| 04 RTC data invalid        | ➤ Device was switched off and backup battery for clock is empty                                    | ➤ Lithium battery is used up. <a href="#">Replace battery</a> . |
| 05 SD Card n. inserted     | ➤ The function to store measurement values and/or error was activated, but no SD card was inserted | ➤ Insert SD card                                                |

## Further possible errors

| Error pattern                                                                                                                           | Possible causes                                                                                                                                                                                            | Solution, troubleshooting measures                                                                                                                                                                        |
|-----------------------------------------------------------------------------------------------------------------------------------------|------------------------------------------------------------------------------------------------------------------------------------------------------------------------------------------------------------|-----------------------------------------------------------------------------------------------------------------------------------------------------------------------------------------------------------|
| Current loop does not function properly                                                                                                 | <ul style="list-style-type: none"> <li>➤ Incorrect measurement value at the output or no current measurable</li> </ul>                                                                                     | <ul style="list-style-type: none"> <li>➤ Load too large</li> </ul>                                                                                                                                        |
| The device does not function immediately after being switched on.<br>No display indication.<br>LEDs on control card flash               | <ul style="list-style-type: none"> <li>➤ Hardware error or error after firmware update, depending on the LED code shown. See following section "<a href="#">Error messages after self-test</a>"</li> </ul> | <ul style="list-style-type: none"> <li>➤ If an SD card has been inserted, these notifications are stored in text form in the error log – even when the error recording function is not active.</li> </ul> |
| Device does not function, even though it is switched on.<br>No display indication<br>All two green LEDs on motherboard light up*        | <ul style="list-style-type: none"> <li>➤ Ribbon cable detached from display board or motherboard</li> <li>➤ Error on display- or motherboard</li> </ul>                                                    | <ul style="list-style-type: none"> <li>➤ Plug ribbon cable back in</li> <li>➤ Replace display- or motherboard</li> </ul>                                                                                  |
| Device does not function, although it is switched on<br>No display indication<br>Fewer than two green LEDs on the motherboard light up* | <ul style="list-style-type: none"> <li>➤ No power supply</li> <li>➤ Fuses on the power supply board defective</li> </ul>                                                                                   | <ul style="list-style-type: none"> <li>➤ See <a href="#">Replacing fuses</a></li> </ul>                                                                                                                   |

## EMC malfunctions due to the solenoid valves

The MultiControl CT complies with the applicable EMC directives. However, we are aware of cases where devices have been disabled due to voltage spikes from solenoid valves.

The devices worked again after restarting, but no safe system operation is guaranteed.

We therefore recommend that solenoid valves, if not already integrated, be equipped with additional so-called 'RC quenching circuits'.

RC circuits, which are connected in parallel to the valve connections, are typical. We recommend values for  $R = 100 \Omega$  and  $C = 100 \text{ nF}$ .

Some solenoid valves are only equipped with varistors as voltage limiters. Again, we recommend the use of RC quenching circuits.

## Error messages after self-test



When switched on, the MultiControl CT performs a self-test automatically and then monitors its own state continuously. If the LEDs under the LCD display (see [Operating display](#)) flash red after switching on (flash frequency 10 Hz), an error has occurred after the self-test. The error message [is placed on the SD card in the error log](#), even when the "[Saving changes](#)" function is inactive.

| EC1 | EC2 | desalination | inlet | dosing | pump | Error number/text in alarm log on SD card | Solution, troubleshooting measures                                                                                                          |                                                                                                                 |
|-----|-----|--------------|-------|--------|------|-------------------------------------------|---------------------------------------------------------------------------------------------------------------------------------------------|-----------------------------------------------------------------------------------------------------------------|
| ☼   | ○   | ○            | ○     | ○      | ○    | 580 CTRL-FRAM IC2                         | Defective component.<br>Repair/exchange required.                                                                                           |                                                                                                                 |
| ○   | ☼   | ○            | ○     | ○      | ○    | 581 CTRL-DS1803                           |                                                                                                                                             |                                                                                                                 |
| ☼   | ☼   | ○            | ○     | ○      | ○    | 582 GP-PCF8574A-IC2                       | Loose cable between motherboard and display?<br>If not: Defective, repair required.                                                         |                                                                                                                 |
| ○   | ○   | ☼            | ○     | ○      | ○    | 583 GP-PCF8574A-IC5                       |                                                                                                                                             |                                                                                                                 |
| ☼   | ○   | ☼            | ○     | ○      | ○    | 590 Font file                             | Character set or menu language could not be read.<br><br>Perform firmware update again.<br><br>If the error persists, a repair is required. |                                                                                                                 |
| ○   | ☼   | ☼            | ○     | ○      | ○    | 591 Font info                             |                                                                                                                                             |                                                                                                                 |
| ☼   | ☼   | ☼            | ○     | ○      | ○    | 592 Font char                             |                                                                                                                                             |                                                                                                                 |
| ○   | ○   | ○            | ☼     | ○      | ○    | 593 Language file                         |                                                                                                                                             |                                                                                                                 |
| ☼   | ○   | ○            | ☼     | ○      | ○    | 594 Language header                       |                                                                                                                                             |                                                                                                                 |
| ○   | ☼   | ○            | ☼     | ○      | ○    | 595 Language info                         |                                                                                                                                             |                                                                                                                 |
| ☼   | ☼   | ○            | ☼     | ○      | ○    | 596 Menu entry not found                  |                                                                                                                                             |                                                                                                                 |
| ○   | ○   | ☼            | ☼     | ○      | ○    | 597 Language magic                        |                                                                                                                                             |                                                                                                                 |
| ☼   | ○   | ☼            | ☼     | ○      | ○    | 598 FIFO overflow                         |                                                                                                                                             |                                                                                                                 |
| ○   | ☼   | ☼            | ☼     | ○      | ○    | 571 EC-AD7994                             |                                                                                                                                             | Replacement of the plug-in card required: EC/pH or EC inductive/pH; these components are included on both cards |
| ☼   | ☼   | ☼            | ☼     | ○      | ○    | 572 EC-PCF8574-IC1                        |                                                                                                                                             |                                                                                                                 |
| ○   | ○   | ○            | ○     | ☼      | ○    | 573 ECPH-Max5381                          |                                                                                                                                             |                                                                                                                 |
| ☼   | ○   | ○            | ○     | ☼      | ○    | 574 ECPH-PCF8574-IC4                      |                                                                                                                                             | Replacement of the EC/pH plug-in card required                                                                  |
| ○   | ☼   | ○            | ○     | ☼      | ○    | 575 ECPH-PCF8574-IC4                      |                                                                                                                                             |                                                                                                                 |
| ☼   | ☼   | ○            | ○     | ☼      | ○    | 576 ECPH-MAX31865-IC13                    |                                                                                                                                             |                                                                                                                 |
| ○   | ○   | ☼            | ○     | ☼      | ○    | 577 ADI-MCP4726-IC7"                      | Replacement of the ADI plug-in card required                                                                                                |                                                                                                                 |
| ☼   | ○   | ☼            | ○     | ☼      | ○    | 578 ADI-MCP4726-IC8                       |                                                                                                                                             |                                                                                                                 |
| ☼   | ○   | ☼            | ☼     | ☼      | ○    | 564 No measure card                       | No measurement plug-in card found                                                                                                           |                                                                                                                 |
| ☼   | ○   | ☼            | ☼     | ☼      | ○    | 563 Wrong firmware                        | Wrong firmware for this device, install correct firmware                                                                                    |                                                                                                                 |

☼ : Rapidly flashing red LED (around 10 Hz).



## Firmware update error list



Rapidly flashing (10Hz) *green* LEDs under the LCD display identify a bootloader error during a firmware update (for comparison: *red* flashing LEDs in the event of self-test errors).

The error category is based on the number of simultaneously flashing LEDs on the control card (for the precise error description, please refer to the following table):

- **All five LEDs flash quickly:** SD card cannot be read. Replace card. If the attempted replacement fails, there is a defect on the control card. Contact customer support; the device must be repaired.
- **Three or four LEDs flash quickly:** Defect on the control card. Contact customer support; the device must be repaired.
- **Two LEDs flash quickly:** The file for the firmware update was found, but is invalid or defective. Re-download the file.
- **One LED flashes quickly:** Problem with SD card (Write protection, formatting).
- For the MultiControl CT the filename should correspond to the following format: 200M001S00.UPD, where 001 is the version number, which increases incrementally as new versions are released.
- **Green LED bar not extended:** It reverts to the original configuration after some time has elapsed and starts from scratch: That means that during the programming, an error was detected and an attempt was made to resolve the error by repeating the update process. The entire programming process is repeated up to five times. The entire programming process is repeated up to five times. For each repeat, the entire programming process is relaunched from the start, whereupon the LED bar "emerge".  
If, after five attempts, it is still impossible to perform any successful update, the LEDs show an error corresponding to the list on the following page. The device or the control card requires repair.  
Please also send – particularly in this case – the content of the log file on the SD card "update.txt" with the item or enclose the SD card with the device.

Under normal cases, a firmware update is completed within 70 seconds.

| LED EC1 | LED EC2 | LED desali-nation | LED inlet | LED dosing | Error number/text in update.txt on SD card | Solution, troubleshooting measures                                                                                            |
|---------|---------|-------------------|-----------|------------|--------------------------------------------|-------------------------------------------------------------------------------------------------------------------------------|
| ☀       | ○       | ○                 | ○         | ○          | 900 No SD-Card inserted                    | Insert SD card, restart firmware update                                                                                       |
| ○       | ☀       | ○                 | ○         | ○          | 901 SD-Card write protect                  | Confirm write-protect tab on the side of the card, restart firmware update                                                    |
|         |         | ☀                 | ○         | ○          | 902 SD-Card init. failed                   | Re-insert SD card, restart firmware update.<br>In the event of multiple failures, a defect is present and repair is required. |
| ○       | ○       |                   | ☀         | ○          | 903 SD-Card unformatted                    | Format SD card, restart firmware update                                                                                       |
| ☀       | ☀       | ☀                 | ☀         | ☀          | 904 SD-Card read error                     | Inserted SD card defective. Initially replace card.<br>If the defect persists, even after the replacement: Repair             |
| ☀       | ☀       | ☀                 |           | ☀          | 905 PCB SD read error                      | Internal micro SD card defective: Repair                                                                                      |
|         | ☀       | ☀                 | ☀         | ☀          | 906 PCB SD write error                     |                                                                                                                               |
| ☀       | ○       | ☀                 | ☀         | ☀          | 907 PCB SD init failed                     |                                                                                                                               |
| ☀       | ☀       | ○                 | ☀         | ☀          | 908 FRAM read error                        | Read error in internal I <sup>2</sup> C FRAM: Repair                                                                          |
| ☀       | ☀       | ☀                 | ☀         |            | 909 FRAM write error                       |                                                                                                                               |
|         |         | ☀                 | ☀         | ☀          | 910 Flash control busy                     | Error in STM32 Flash: Repair                                                                                                  |
| ○       | ☀       | ☀                 | ☀         |            | 911 Flash program error                    |                                                                                                                               |
| ☀       | ☀       | ☀                 |           |            | 912 Flash write protect                    |                                                                                                                               |
| ☀       | ☀       |                   |           | ☀          | 913 Flash timeout                          | Invalid update (CRC error): Re-download                                                                                       |
| ☀       | ☀       |                   |           |            | 914 UPD file invalid                       |                                                                                                                               |
|         | ☀       | ☀                 |           |            | 915 UPD sec invalid type                   |                                                                                                                               |

☀ : Rapidly flashing green LED (around 10 Hz).

| LED EC1 | LED EC2 | LED desali-nation | LED inlet | LED dosing | Error number/text in update.txt on SD card | Solution, troubleshooting measures                                                            |
|---------|---------|-------------------|-----------|------------|--------------------------------------------|-----------------------------------------------------------------------------------------------|
|         |         | ☼                 | ☼         |            | 916 UPD sec invalid start                  | Start info in update file defective:<br>Re-download                                           |
|         |         |                   | ☼         | ☼          | 917 UPD sect invalid len                   | Length info in update file defective:<br>Re-download                                          |
| ☼       |         | ☼                 |           |            | 918 UPD CRC error                          | Checksum error in update file: Re-download                                                    |
| ☼       |         |                   | ☼         |            | 919 UPD wrong version                      | Incorrect version of the update file:<br>Download the correct file for the appropriate device |
|         |         |                   |           | ☼          | 920 File not found                         | Update file on SD card not found:<br>Recopy                                                   |
|         | ☼       |                   | ☼         |            | 921 App invalid                            | Application invalid                                                                           |
|         |         | ☼                 |           | ☼          | 922 App address invalid                    | Application start address invalid                                                             |
| ☼       |         | ☼                 | ☼         |            | 923 Timeout on RS232                       | Language file missing: Reprogram with new update file                                         |
| ☼       |         |                   |           | ☼          | 924 No language file                       | Language file missing: Reprogram with new update file                                         |
|         | ☼       |                   |           | ☼          | 925 Language magic wrong                   | Storage error: Repair                                                                         |
| ☼       |         |                   | ☼         | ☼          | 926 Error mem alloc                        | Software error: Repair                                                                        |
|         | ☼       |                   | ☼         | ☼          | 927 Assertion failed                       | Unknown error: Contact support department, repair                                             |
| ☼       |         | ☼                 |           | ☼          | 928 Unknown error                          | Start info in update file defective:<br>Re-download                                           |

☼ : Rapidly flashing green LED (around 10 Hz).

## Disassembly

---



### **Risk of injuries when disassembling live parts!**

If the power supply is not disconnected prior to disassembly, it may result in physical injuries, destruction of the product or damage to plant parts.

- Always disconnect the relevant plant parts before disassembling MultiControl CT.
- 

- Open the housing.
- Remove all connected cables.
- Disconnect the plug connectors from the or the plug-in cards.
- Remove the plug-in cards.
- Take the MultiControl CT down from the wall.

## Structure of service menu

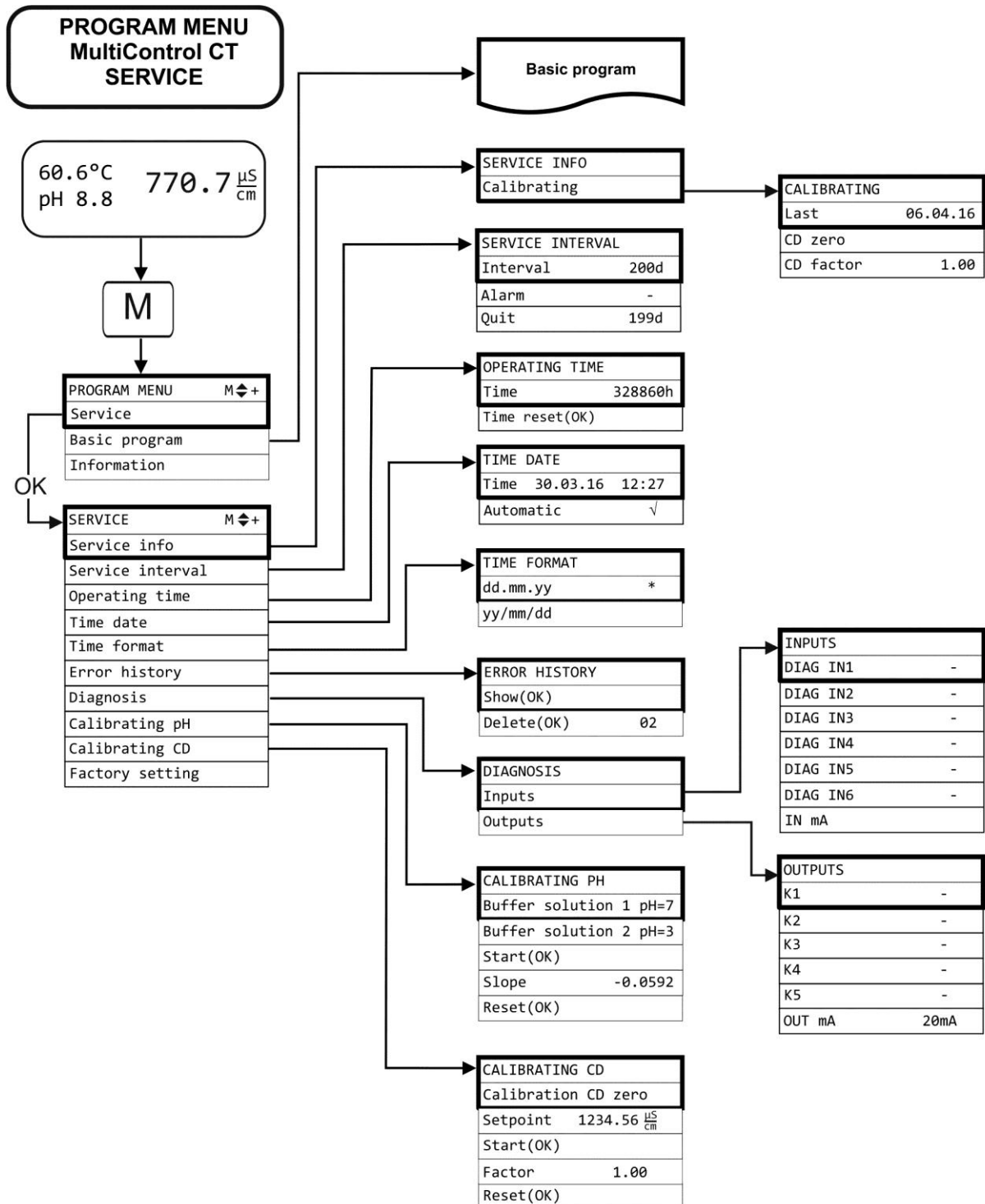

# Structure of basic programming

Top part of the menu tree

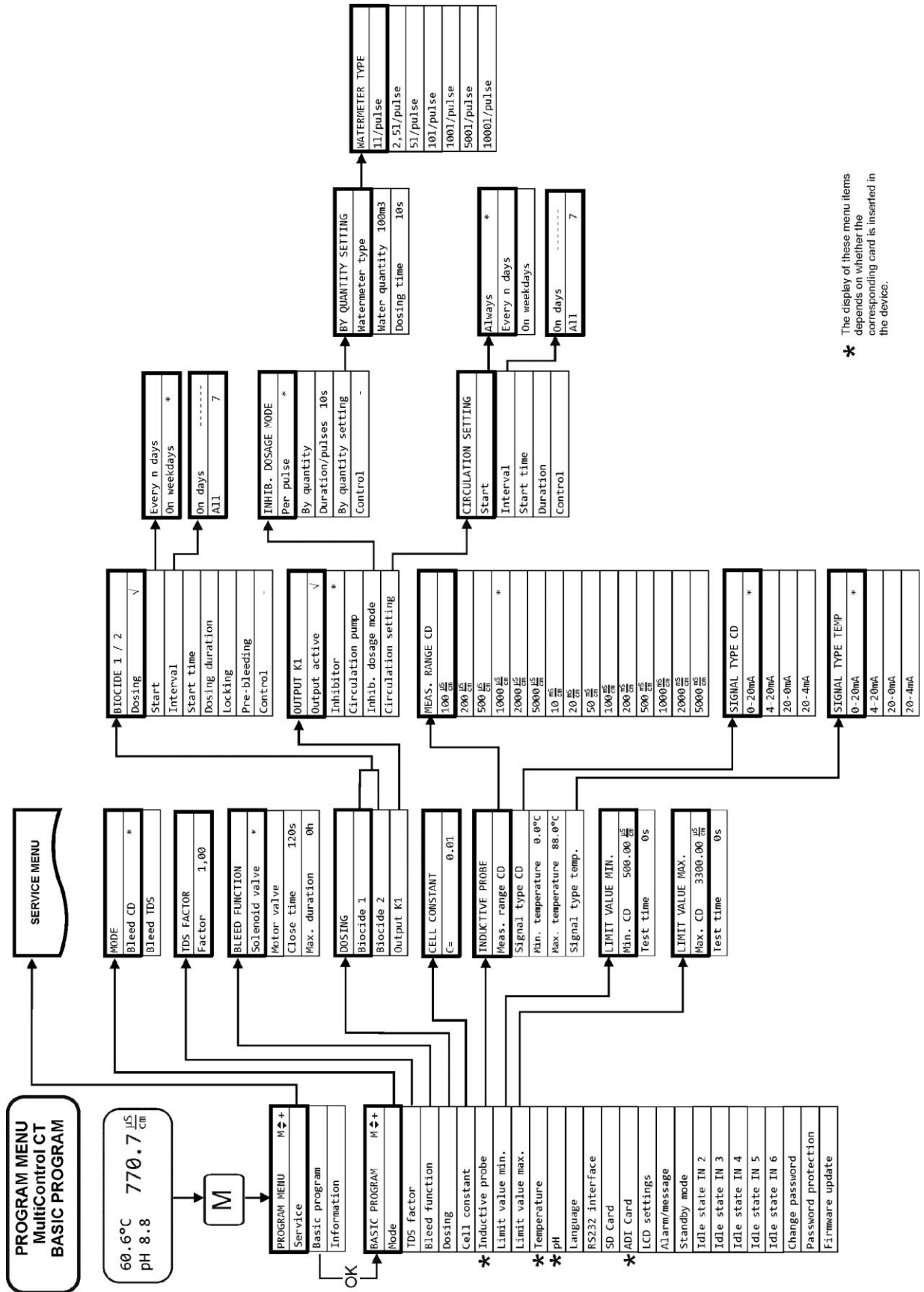

Middle part of the menu tree

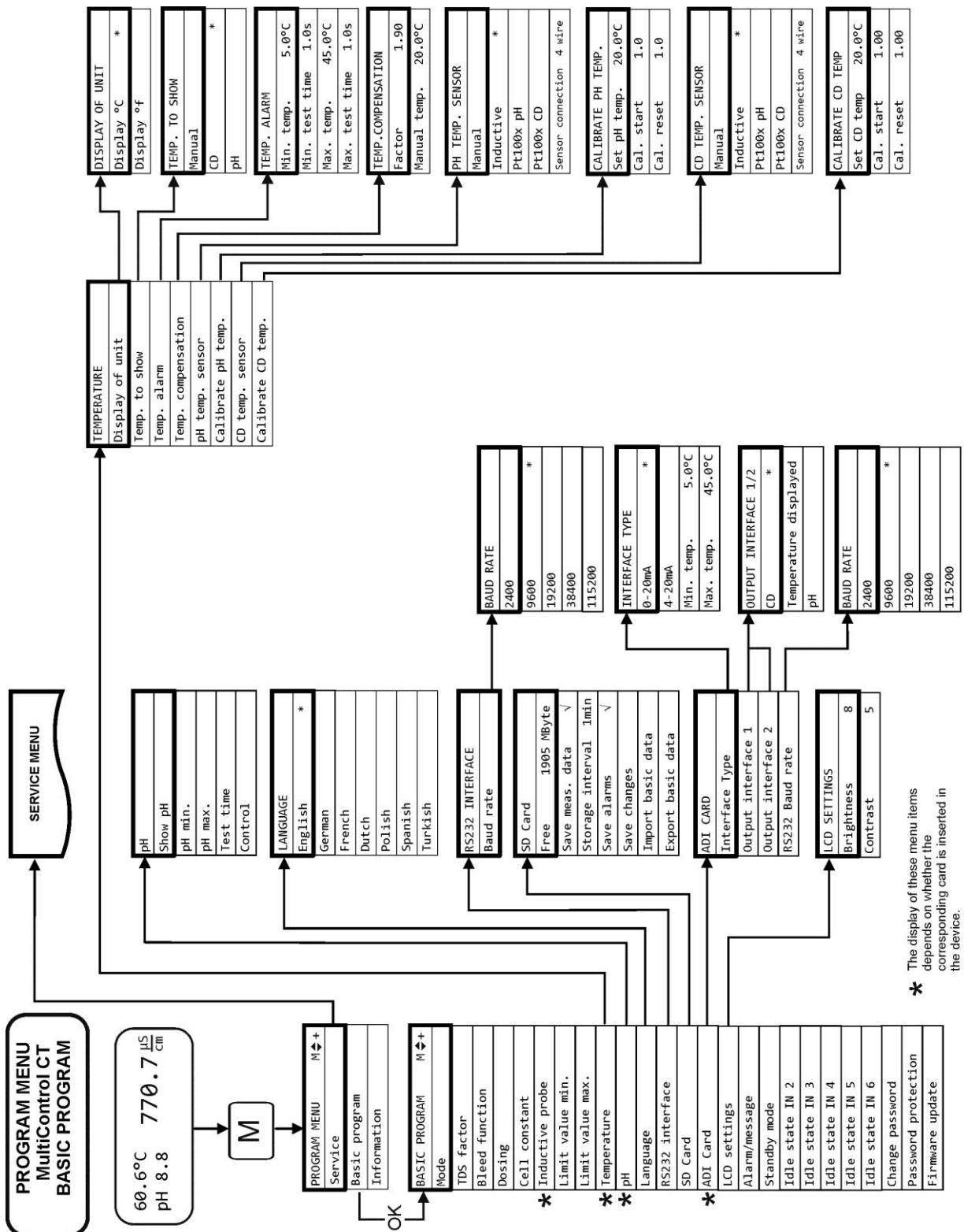

Bottom part of the menu tree

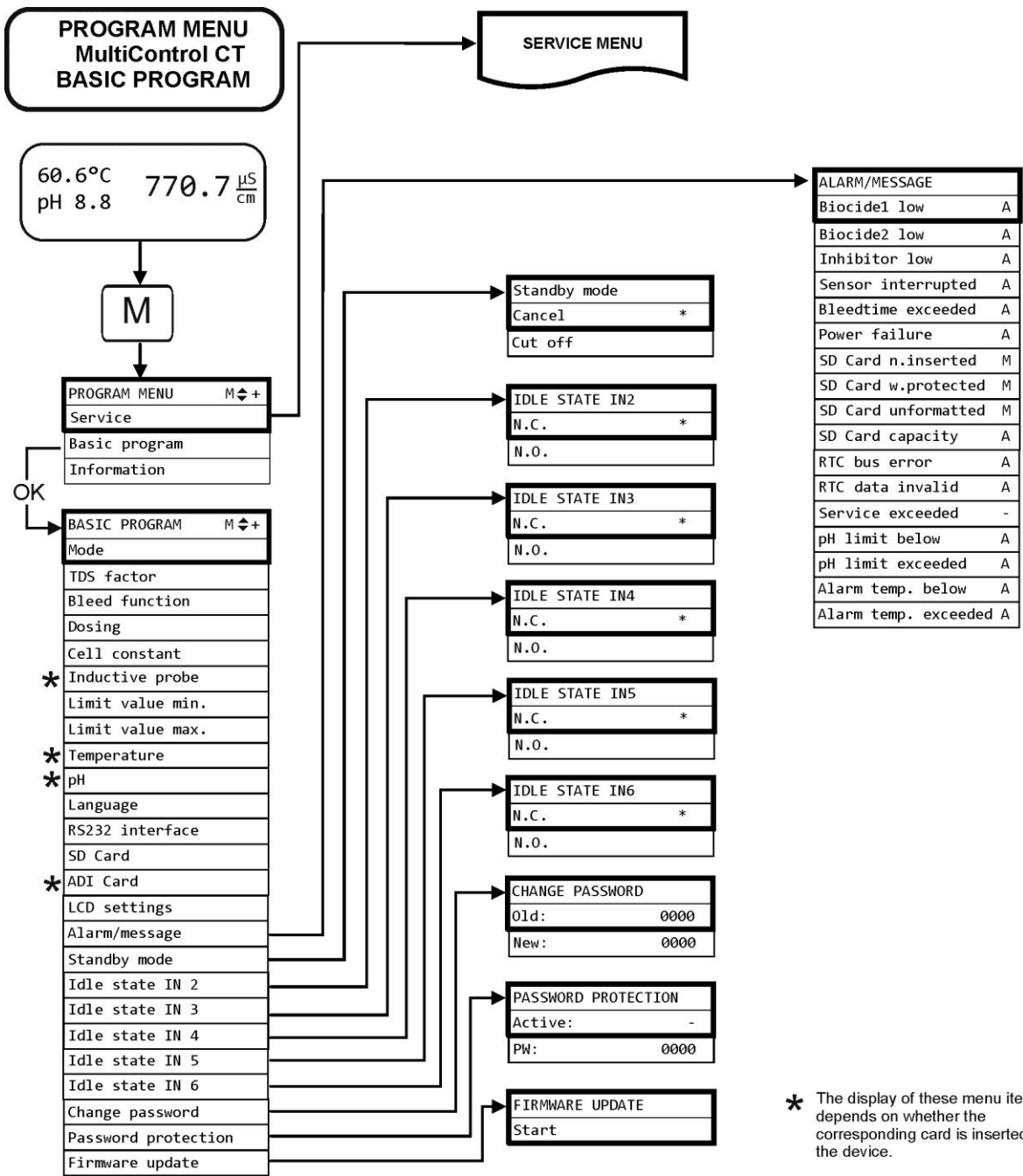



## Structure of information menu

The menu tree is identical to the basic program, with the difference that the settings can not be changed! Only the settings and functions for which settings have been made are displayed.

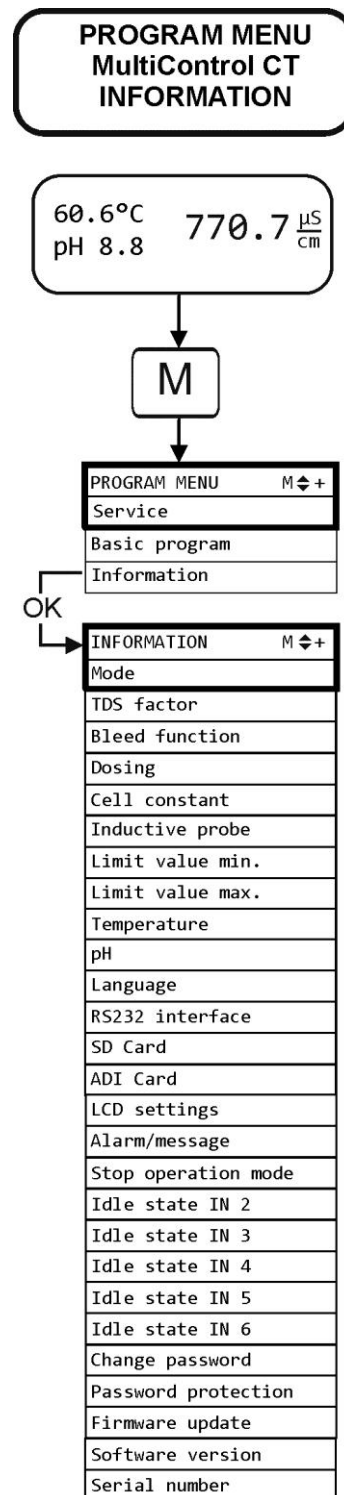

## Accessories

### Conductive conductivity probes without temperature sensor

Use with EC/pH plug-in card only!

| Type   | Cell const.<br>[1/cm] | Max. temp<br>[°C] | Meas. range<br>[μS/cm] | Order<br>no |
|--------|-----------------------|-------------------|------------------------|-------------|
| SO 1   | 0,1                   | 40                | 1 - 2.000              | 310001      |
| SO 5   | 0,5                   | 40                | 5 - 10.000             | 310003      |
| SO 10  | 1                     | 40                | 10 - 20.000            | 310014      |
| SOE 0  | 0,01                  | 130               | 0,1 - 200              | 310005      |
| SOE 1  | 0,1                   | 130               | 1 - 2.000              | 310002      |
| SOE 5  | 0,5                   | 130               | 5 - 10.000             | 310004      |
| SOE 50 | 5                     | 80                | 100 - 100.000          | 310050      |
| SEI 1  | 0,1                   | 40                | 1 - 2.000              | 310101      |
| SEI 5  | 0,5                   | 40                | 5 - 10.000             | 310103      |
| SD 10  | 1                     | 40                | 10 - 20.000            | 310013      |

### Conductive conductivity probes with temperature sensor PT100

Use with EC/pH plug-in card only!

| Type                             | Cell const.<br>[1/cm] | Max. temp<br>[°C] | Meas. range<br>[μS/cm] | Order<br>no |
|----------------------------------|-----------------------|-------------------|------------------------|-------------|
| ST 1/PT100                       | 0,1                   | 40                | 1 - 2.000              | 310120      |
| ST 5/PT100                       | 0,5                   | 40                | 5 - 10.000             | 310121      |
| ST 10/PT100                      | 1                     | 40                | 10 - 20.000            | 310123      |
| STE 0/PT100                      | 0,01                  | 130               | 0,1 - 200              | 310110      |
| STE 1/PT100                      | 0,1                   | 130               | 1 - 2.000              | 310125      |
| STE 5/PT100                      | 0,5                   | 130               | 5 - 10.000             | 310126      |
| STE 5/PT100 for<br>measuring rod | 0,5                   | 130               | 5 - 10.000             | 310135      |
| STE 50/PT100                     | 5                     | 80                | 100 - 100.000          | 310129      |
| SEI 1/PT100                      | 0,1                   | 40                | 1 - 2.000              | 310130      |
| SEI 5/PT100                      | 0,5                   | 40                | 5 - 10.000             | 310131      |

#### Cable

Cable for STE 5/PT100 for measuring rod, length 10m 310136

## Inductive conductivity probes with temperature sensor

|                                                                |        |
|----------------------------------------------------------------|--------|
| Jumo CTI-500 head measuring converter without display/keyboard | 310132 |
| Jumo CTI-500 head measuring converter with display/keyboard    | 310133 |
| Solumetrix probe BKEX 50-232                                   | 37833  |

## pH probes without temperature sensor

Use with EC/pH plug-in card only!

| Type                       | Pressure<br>[10 <sup>5</sup> Pa<br>/ bar] | Temperature<br>[°C] | Meas. range<br>[pH] | Order<br>no |
|----------------------------|-------------------------------------------|---------------------|---------------------|-------------|
| EMK 20                     | 0-8                                       | 0 - 80              | 1-13                | 320301      |
| pH probe for measuring rod | 0-6                                       | -5 - 135            | 0-14                | 310137      |

## pH probes with temperature sensor

Use with EC/pH plug-in card only!

| Type   | Pressure<br>[10 <sup>5</sup> Pa<br>/ bar] | Temperature<br>[°C] | Meas. range<br>[pH] | Order<br>no |
|--------|-------------------------------------------|---------------------|---------------------|-------------|
| EMK 50 | 0-6                                       | 10-130              | 1-14                | 320302      |

A 10 m long connection cable with Vario Pin (order no. 310138) is available for all probes.

Please refer to our delivery programme for an up-to-date overview of available accessories.

## Technical Data

|                                          |                                                                                   |
|------------------------------------------|-----------------------------------------------------------------------------------|
| Power supply::                           | 230VAC, 24VAC +/-10% 50–60Hz or 100-240VAC, 100-353 VDC (wide-range power supply) |
| Power consumption without exterior load: | max. 25 VA (without external load)                                                |
| Type of protection:                      | IP54                                                                              |
| Degree of protection:                    | I                                                                                 |
| Conformity:                              | EN61326-1, EN61010-1                                                              |
| Ambient temperature:                     | 5 – 40 °C                                                                         |
| Dimensions                               | W x H x D = 229 x 205 x 117 mm                                                    |
| Weight:                                  | Approx. 1,5 kg                                                                    |

| Cell constant             | Measuring range (4 measuring ranges each) | Type of probe                                                        |
|---------------------------|-------------------------------------------|----------------------------------------------------------------------|
| 0,01 cm <sup>-1</sup>     | 0 - 199,9 µS/cm                           | SOE 0, STE 0-PT100                                                   |
| 0,05/0,1 cm <sup>-1</sup> | 0 - 1999 µS/cm                            | SO 1, SOE 1, ST 1-PT100, STE 1-PT100, SEI 1 (-PT100)                 |
| 0,5/1,0 cm <sup>-1</sup>  | 0 – 19,99 mS/cm                           | SO 5/10, SOE 5, ST 5/ST 10-PT100, STE 5-PT100, SEI 5 (-PT100), SD 10 |
| 5,0 cm <sup>-1</sup>      | 0 - 199,9 mS/cm                           | SOE 50, STE 50-PT100                                                 |

|                                                                                     |                                                                             |
|-------------------------------------------------------------------------------------|-----------------------------------------------------------------------------|
| Accuracy:                                                                           | ± 2 digit or ± 5% from the measuring range end, depending on the probe used |
| Resolution:                                                                         | 0.001 µS/cm to 0.1 mS/cm depending on the measuring range                   |
| Automatic or manual temperature compensation, temperature coefficient 0 - 9,99 %/°C |                                                                             |
| Temperature display:                                                                | 0,0 bis 150 °C ± 0,5°C                                                      |
| Current interface:                                                                  | 0/4 - 20 mA, max. load 500 Ω, galvanically isolated                         |
| RS232 interface                                                                     | 2400..115200 baud, 8 Bit, 2 stop bits, no parity                            |

# Conformity Declaration

EC Conformity Declaration



for the following product

**MultiControl CT**  
**Controller for cooling circuits**

We hereby confirm that the above product conforms to the principal health and safety regulations laid down in the EC Directives 2014/30/EU and 2014/35/EU. This declaration applies to all units produced in accordance with the attached manufacturing documents which are a constituent part of this declaration.

The product was assessed with reference to the following standards:

**EN 61000-6-4:** Electromagnetic compatibility, Generic emission standard  
**EN 61000-6-2:** Electromagnetic compatibility, Generic immunity standard  
**EN 61010-1:** Safety requirements for electrical equipment for measurement, control and laboratory use

This declaration is made on behalf of

**GEBRÜDER HEYL**  
**Analysentechnik GmbH & Co. KG**  
**Orleansstraße 75b**  
**31135 Hildesheim**

by

A handwritten signature in blue ink, appearing to read 'Jörg-Tilman Heyl'. Below the signature, the name and title are printed.

Jörg-Tilman Heyl  
General Manager

Hildesheim, 07/10/2016

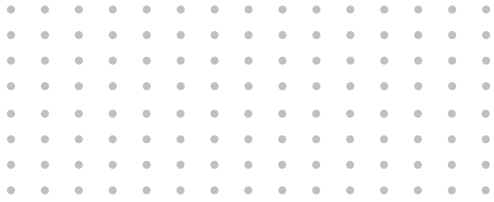

Gebrüder Heyl  
Analysentechnik GmbH  
Orleansstraße 75b  
D 31135 Hildesheim  
[www.heyhl.de](http://www.heyhl.de)

MultiControl\_CT\_GB\_180629.docx



Scan the code and  
visit us on our homepage!